

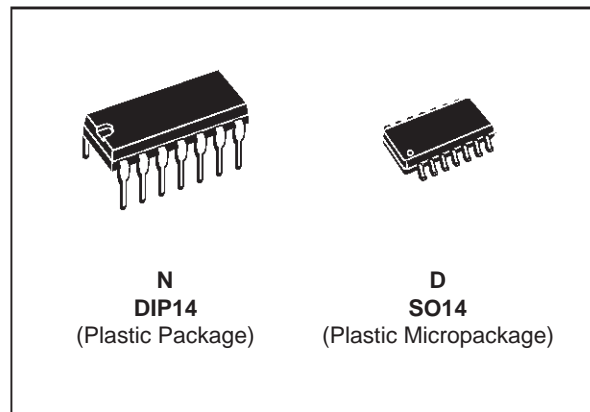

# TS914

## RAIL TO RAIL CMOS QUAD OPERATIONAL AMPLIFIER

- **RAIL TO RAIL** INPUT AND OUTPUT VOLTAGE RANGES
- SINGLE (OR DUAL) SUPPLY OPERATION FROM **2.7V TO 16V**
- EXTREMELY LOW INPUT BIAS CURRENT : **1pA** TYP
- LOW INPUT OFFSET VOLTAGE : 5mV max.
- SPECIFIED FOR **600Ω** AND **100Ω** LOADS
- LOW SUPPLY CURRENT : 200μA/Ampli
- **SPICE MACROMODEL** INCLUDED IN THIS SPECIFICATION



### ORDER CODES

Part Number	Temperature Range	Package	
		N	D
TS914I/AI	-40, +125°C	•	•

### PIN CONNECTIONS (top view)

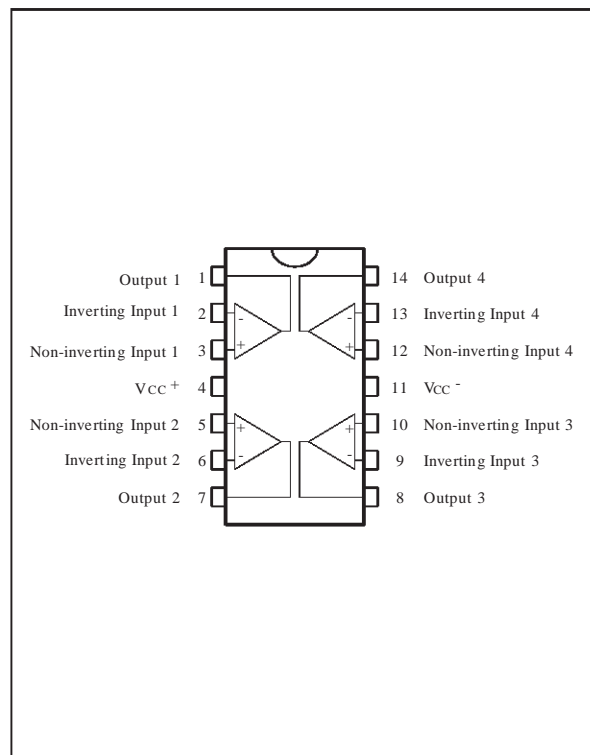

### DESCRIPTION

The TS914 is a RAIL TO RAIL quad CMOS operational amplifier designed to operate with a single or dual supply voltage.

The input voltage range  $V_{icm}$  includes the two supply rails  $V_{CC}^+$  and  $V_{CC}^-$ .

The output reaches :

- $V_{CC}^- + 50mV$      $V_{CC}^+ - 50mV$     with  $R_L = 10k\Omega$
- $V_{CC}^- + 350mV$      $V_{CC}^+ - 350mV$     with  $R_L = 600\Omega$

This product offers a broad supply voltage operating range from 2.7V to 16V and a supply current of only 200μA/amp. ( $V_{CC} = 3V$ ).

Source and sink output current capability is typically 40mA (at  $V_{CC} = 3V$ ), fixed by an internal limitation circuit.

STMicroelectronics is offering a dual op-amp with the same features : TS912.

**SCHEMATIC DIAGRAM (1/4 TS914)**

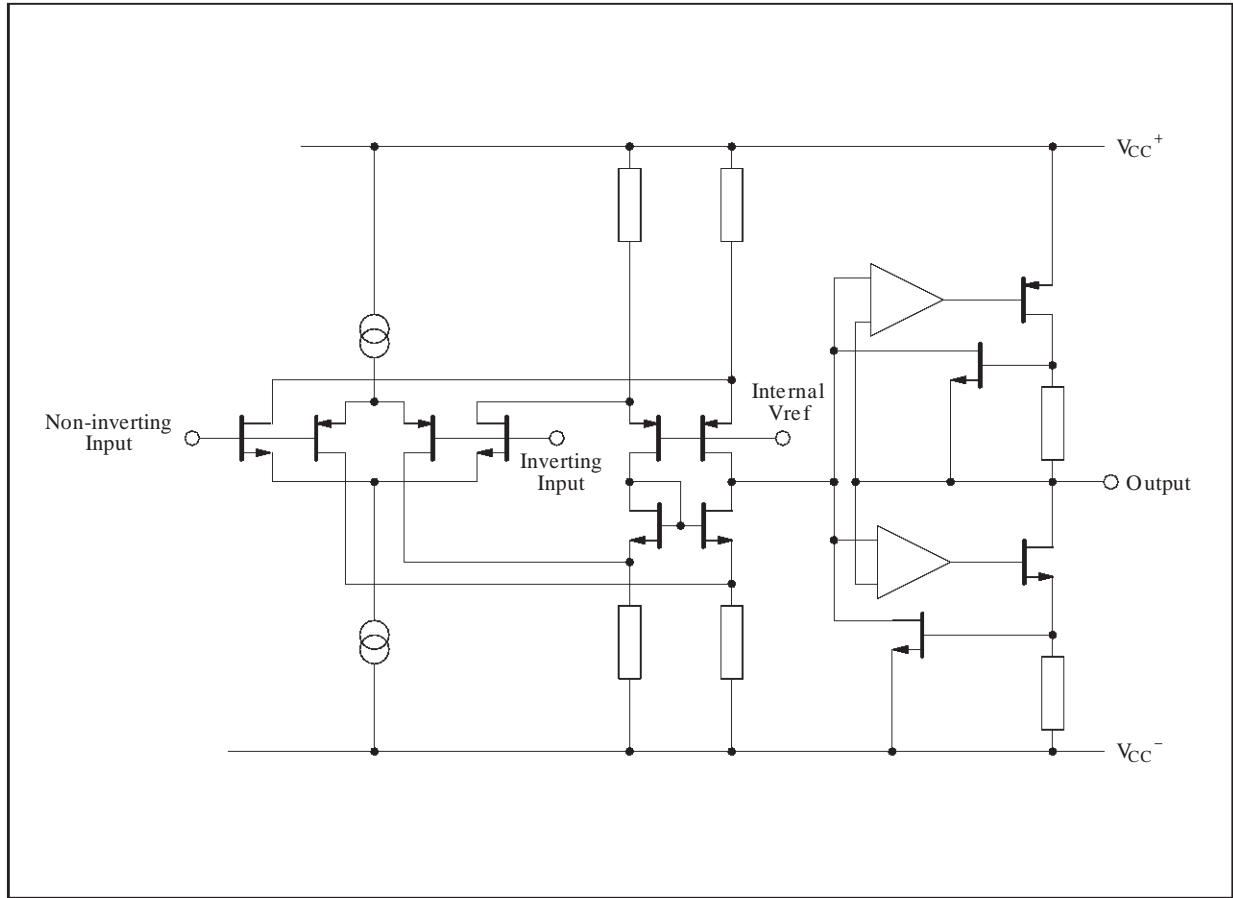

**ABSOLUTE MAXIMUM RATINGS**

Symbol	Parameter	Value	Unit
V <sub>CC</sub>	Supply Voltage - (note 1)	18	V
V <sub>id</sub>	Differential Input Voltage - (note 2)	±18	V
V <sub>i</sub>	Input Voltage - (note 3)	-0.3 to 18	V
I <sub>in</sub>	Current on Inputs	±50	mA
I <sub>o</sub>	Current on Outputs	±130	mA
T <sub>oper</sub>	Operating Free Air Temperature Rangel	-40 to +125	°C
T <sub>stg</sub>	Storage Temperature	-65 to +150	°C

**Notes :** 1. All voltage values, except differential voltage are with respect to network ground terminal.  
 2. Differential voltages are the non-inverting input terminal with respect to the inverting input terminal.  
 3. The magnitude of input and output voltages must never exceed V<sub>CC</sub><sup>+</sup> +0.3V.

**OPERATING CONDITIONS**

Symbol	Parameter	Value	Unit
V <sub>CC</sub>	Supply Voltage	2.7 to 16	V
V <sub>icm</sub>	Common Mode Input Voltage Range	V <sub>CC</sub> <sup>-</sup> -0.2 to V <sub>CC</sub> <sup>+</sup> +0.2	V

**ELECTRICAL CHARACTERISTICS**

$V_{CC}^+ = 3V, V_{CC}^- = 0V, R_L, C_L$  connected to  $V_{CC}/2, T_{amb} = 25^\circ C$  (unless otherwise specified)

Symbol	Parameter	TS914/AI			Unit
		Min.	Typ.	Max.	
$V_{io}$	Input Offset Voltage ( $V_{ic} = V_o = V_{CC}/2$ ) $T_{min.} \leq T_{amb} \leq T_{max.}$			10 5 12 7	mV
$DV_{io}$	Input Offset Voltage Drift		5		$\mu V/^\circ C$
$I_{io}$	Input Offset Current - (note 1) $T_{min.} \leq T_{amb} \leq T_{max.}$		1	100 200	pA
$I_{ib}$	Input Bias Current - (note 1) $T_{min.} \leq T_{amb} \leq T_{max.}$		1	150 300	pA
$I_{CC}$	Supply Current (per amplifier, $A_{VCL} = 1$ , no load) $T_{min.} \leq T_{amb} \leq T_{max.}$		200	300 400	$\mu A$
CMR	Common Mode Rejection Ratio $V_{ic} = 0$ to $3V, V_o = 1.5V$		70		dB
SVR	Supply Voltage Rejection Ratio ( $V_{CC}^+ = 2.7$ to $3.3V, V_o = V_{CC}/2$ )	40	70		dB
$A_{vd}$	Large Signal Voltage Gain ( $R_L = 10k\Omega, V_o = 1.2V$ to $1.8V$ ) $T_{min.} \leq T_{amb} \leq T_{max.}$	3 2	10		V/mV
$V_{OH}$	High Level Output Voltage ( $V_{id} = 1V$ ) $T_{min.} \leq T_{amb} \leq T_{max.}$	$R_L = 10k\Omega$ $R_L = 600\Omega$ $R_L = 100\Omega$  $R_L = 10k\Omega$ $R_L = 600\Omega$	2.9 2.3  2.8 2.1	2.96 2.6 2	V
$V_{OL}$	Low Level Output Voltage ( $V_{id} = -1V$ ) $T_{min.} \leq T_{amb} \leq T_{max.}$	$R_L = 10k\Omega$ $R_L = 600\Omega$ $R_L = 100\Omega$  $R_L = 10k\Omega$ $R_L = 600\Omega$		50 300 900  150 600	mV
$I_o$	Output Short Circuit Current ( $V_{id} = \pm 1V$ )	Source ( $V_o = V_{CC}^-$ ) Sink ( $V_o = V_{CC}^+$ )	40 40		mA
GBP	Gain Bandwidth Product ( $A_{VCL} = 100, R_L = 10k\Omega, C_L = 100pF, f = 100kHz$ )		0.8		MHz
$SR^+$	Positive Slew Rate $A_{VCL} = 1, R_L = 10k\Omega, V_i = 1.3V$ to $1.7V, C_L = 100pF$		0.5		V/ $\mu s$
$SR^-$	Negative Slew Rate		0.4		V/ $\mu s$
$\phi_m$	Phase Margin		30		Degrees
$e_n$	Equivalent Input Noise Voltage ( $R_s = 100\Omega, f = 1kHz$ )		30		$\frac{nV}{\sqrt{Hz}}$
$V_{O1}/V_{O2}$	Channel Separation ( $f = 1kHz$ )		120		dB

**Note 1 :** Maximum values including unavoidable inaccuracies of the industrial test.

**ELECTRICAL CHARACTERISTICS**

$V_{CC}^+ = 5V$ ,  $V_{CC}^- = 0V$ ,  $R_L, C_L$  connected to  $V_{CC}/2$ ,  $T_{amb} = 25^\circ C$  (unless otherwise specified)

Symbol	Parameter	TS914/AI			Unit
		Min.	Typ.	Max.	
$V_{io}$	Input Offset Voltage ( $V_{ic} = V_o = V_{CC}/2$ ) $T_{min.} \leq T_{amb} \leq T_{max.}$			10 5 12 7	mV
$DV_{io}$	Input Offset Voltage Drift		5		$\mu V/^\circ C$
$I_{io}$	Input Offset Current - (note 1) $T_{min.} \leq T_{amb} \leq T_{max.}$		1	100 200	pA
$I_{ib}$	Input Bias Current - (note 1) $T_{min.} \leq T_{amb} \leq T_{max.}$		1	150 300	pA
$I_{CC}$	Supply Current (per amplifier, $A_{VCL} = 1$ , no load) $T_{min.} \leq T_{amb} \leq T_{max.}$		230	350 450	$\mu A$
CMR	Common Mode Rejection Ratio $V_{ic} = 1.5$ to $3.5V$ , $V_o = 2.5V$	50	75		dB
SVR	Supply Voltage Rejection Ratio ( $V_{CC}^+ = 3$ to $5V$ , $V_o = V_{CC}/2$ )	50	80		dB
$A_{vd}$	Large Signal Voltage Gain ( $R_L = 10k\Omega$ , $V_o = 1.5V$ to $3.5V$ ) $T_{min.} \leq T_{amb} \leq T_{max.}$	10 7	30		V/mV
$V_{OH}$	High Level Output Voltage ( $V_{id} = 1V$ ) $T_{min.} \leq T_{amb} \leq T_{max.}$	$R_L = 10k\Omega$ 4.90 $R_L = 600\Omega$ 4.25 $R_L = 100\Omega$	4.95 4.65 3.7		V
$V_{OL}$	Low Level Output Voltage ( $V_{id} = -1V$ ) $T_{min.} \leq T_{amb} \leq T_{max.}$	$R_L = 10k\Omega$ $R_L = 600\Omega$ $R_L = 100\Omega$	50 350 1400	100 500	mV
$I_o$	Output Short Circuit Current ( $V_{id} = \pm 1V$ )	Source ( $V_o = V_{CC}^-$ ) Sink ( $V_o = V_{CC}^+$ )	45 45	60 60	mA
GBP	Gain Bandwidth Product ( $A_{VCL} = 100$ , $R_L = 10k\Omega$ , $C_L = 100pF$ , $f = 100kHz$ )		0.9		MHz
$SR^+$	Positive Slew Rate $A_{VCL} = 1$ , $R_L = 10k\Omega$ , $V_i = 1V$ to $4V$ , $C_L = 100pF$		0.8		V/ $\mu s$
$SR^-$	Negative Slew Rate		0.5		V/ $\mu s$
$\phi_m$	Phase Margin		30		Degrees

**Note 1 :** Maximum values including unavoidable inaccuracies of the industrial test.

**ELECTRICAL CHARACTERISTICS**

$V_{CC}^+ = 10V, V_{CC}^- = 0V, R_L, C_L$  connected to  $V_{CC}/2, T_{amb} = 25^\circ C$  (unless otherwise specified)

Symbol	Parameter	TS914/AI			Unit
		Min.	Typ.	Max.	
$V_{io}$	Input Offset Voltage ( $V_{ic} = V_o = V_{CC}/2$ ) $T_{min.} \leq T_{amb} \leq T_{max.}$	TS914 TS914A TS914 TS914A		10 5 12 7	mV
$DV_{io}$	Input Offset Voltage Drift		5		$\mu V/^\circ C$
$I_{io}$	Input Offset Current - (note 1) $T_{min.} \leq T_{amb} \leq T_{max.}$		1	100 200	pA
$I_{ib}$	Input Bias Current - (note 1) $T_{min.} \leq T_{amb} \leq T_{max.}$		1	150 300	pA
$I_{CC}$	Supply Current (per amplifier, $A_{VCL} = 1$ , no load) $T_{min.} \leq T_{amb} \leq T_{max.}$		400	600 700	$\mu A$
CMR	Common Mode Rejection Ratio $V_{ic} = 3$ to $7V, V_o = 5V$ $V_{ic} = 0$ to $10V, V_o = 5V$		50	75 70	dB
SVR	Supply Voltage Rejection Ratio ( $V_{CC}^+ = 5$ to $10V, V_o = V_{CC}/2$ )		50	80	dB
$A_{vd}$	Large Signal Voltage Gain ( $R_L = 10k\Omega, V_o = 2.5V$ to $7.5V$ ) $T_{min.} \leq T_{amb} \leq T_{max.}$		20 15	60	V/mV
$V_{OH}$	High Level Output Voltage ( $V_{id} = 1V$ ) $T_{min.} \leq T_{amb} \leq T_{max.}$	$R_L = 10k\Omega$ $R_L = 600\Omega$ $R_L = 100\Omega$  $R_L = 10k\Omega$ $R_L = 600\Omega$	9.85 9.2  9.8 9	9.95 9.35 7.8	V
$V_{OL}$	Low Level Output Voltage ( $V_{id} = -1V$ ) $T_{min.} \leq T_{amb} \leq T_{max.}$	$R_L = 10k\Omega$ $R_L = 600\Omega$ $R_L = 100\Omega$  $R_L = 10k\Omega$ $R_L = 600\Omega$		50 650 2300  150 900	mV
$I_o$	Output Short Circuit Current ( $V_{id} = \pm 1V$ )	Source ( $V_o = V_{CC}^-$ ) Sink ( $V_o = V_{CC}^+$ )	45 45	60 60	mA
GBP	Gain Bandwidth Product ( $A_{VCL} = 100, R_L = 10k\Omega, C_L = 100pF, f = 100kHz$ )			1.3	MHz
$SR^+$	Positive Slew Rate $A_{VCL} = 1, R_L = 10k\Omega, V_i = 2.5V$ to $7.5V, C_L = 100pF$			1.3	V/ $\mu s$
$SR^-$	Negative Slew Rate			0.8	V/ $\mu s$
$\phi_m$	Phase Margin			40	Degrees
$e_n$	Equivalent Input Noise Voltage ( $R_s = 100\Omega, f = 1kHz$ )			30	$\frac{nV}{\sqrt{Hz}}$
THD	Total Harmonic Distortion ( $A_{VCL} = 1, R_L = 10k\Omega, C_L = 100pF, V_o = 4.75V$ to $5.25V, f = 1kHz$ )			0.024	%
$C_{in}$	Input Capacitance			1.5	pF
$V_{O1}/V_{O2}$	Channel Separation ( $f = 1kHz$ )			120	dB

**Note 1** : Maximum values including unavoidable inaccuracies of the industrial test.

TYPICAL CHARACTERISTICS

Figure 1 : Supply Current (each amplifier) vs Supply Voltage

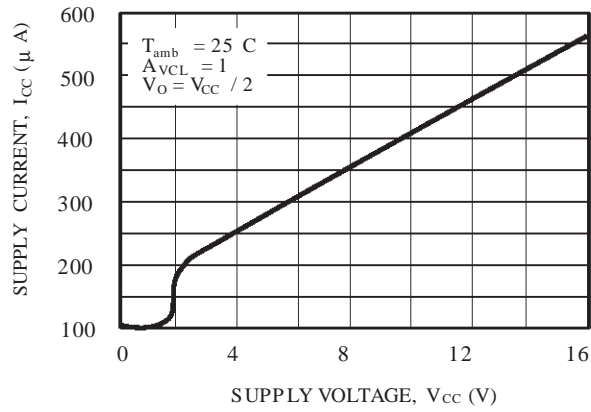

Figure 2 : Input Bias Current vs Temperature

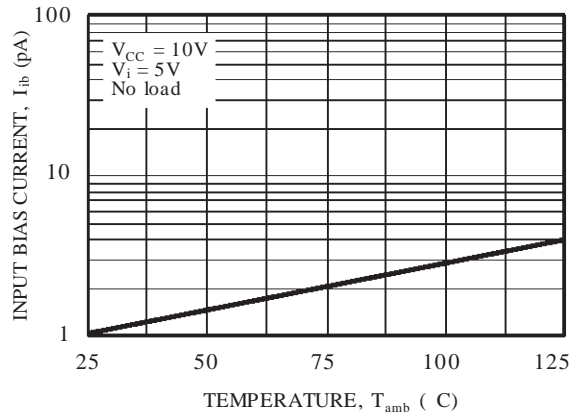

Figure 3a : High Level Output Voltage vs High Level Output Current

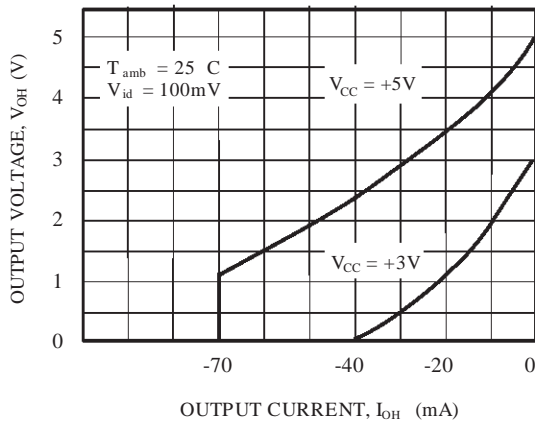

Figure 3b : High Level Output Voltage vs High Level Output Current

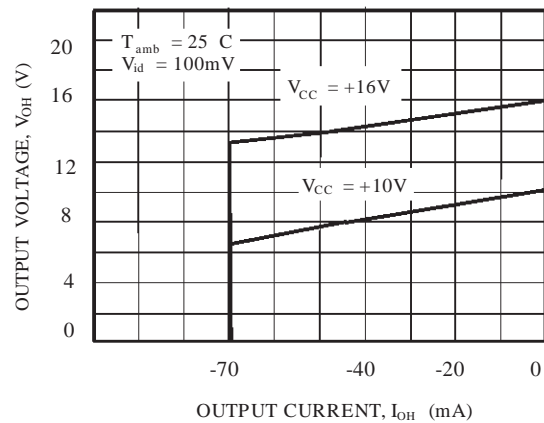

Figure 4a : Low Level Output Voltage vs Low Level Output Current

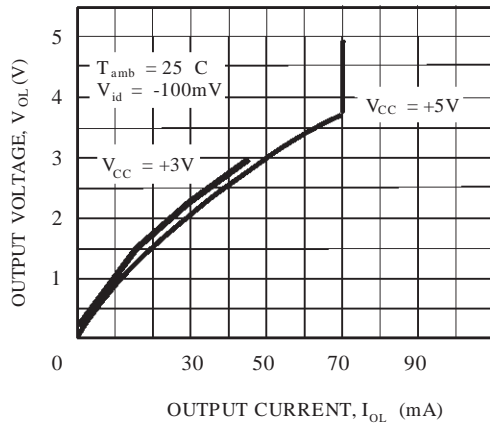

Figure 4b : Low Level Output Voltage vs Low Level Output Current

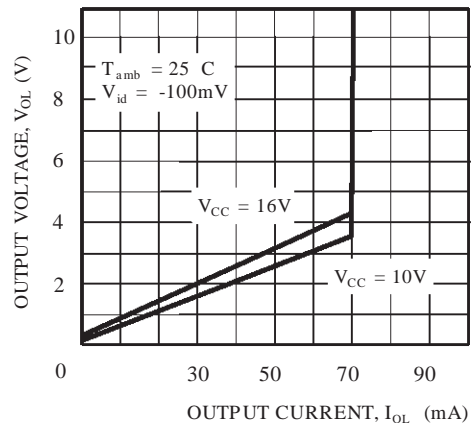

Figure 5a : Gain and Phase vs Frequency

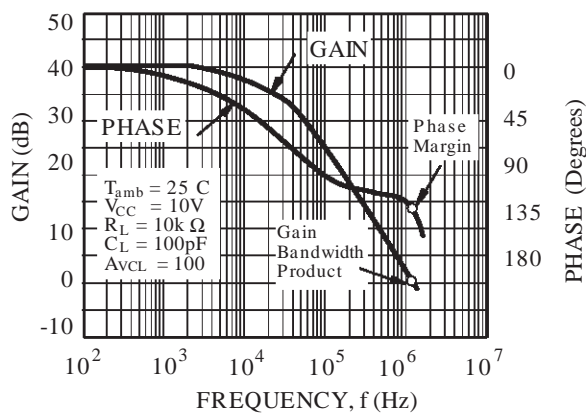

Figure 5b : Gain and Phase vs Frequency

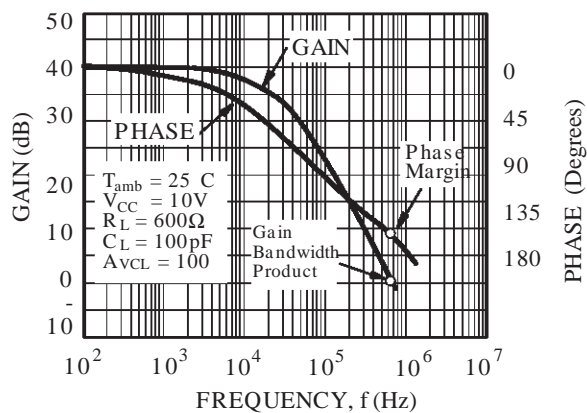

Figure 6a : Gain Bandwidth Product vs Supply Voltage

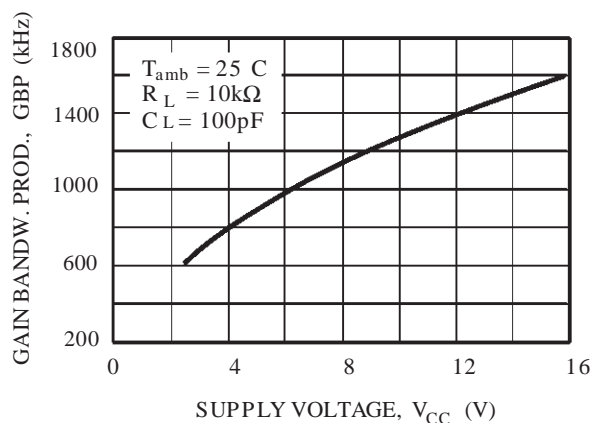

Figure 6b : Gain bandwidth Product vs Supply Voltage

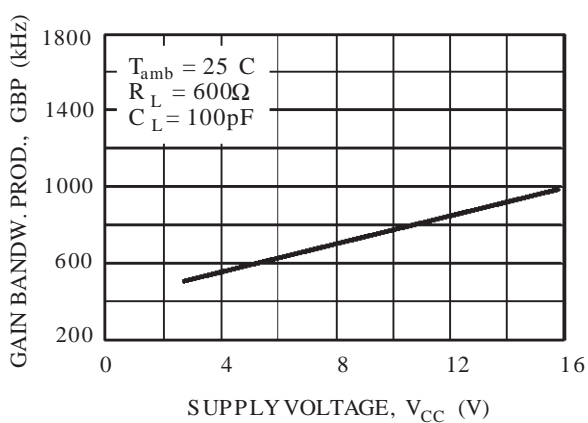

Figure 7a : Phase Margin vs Supply Voltage

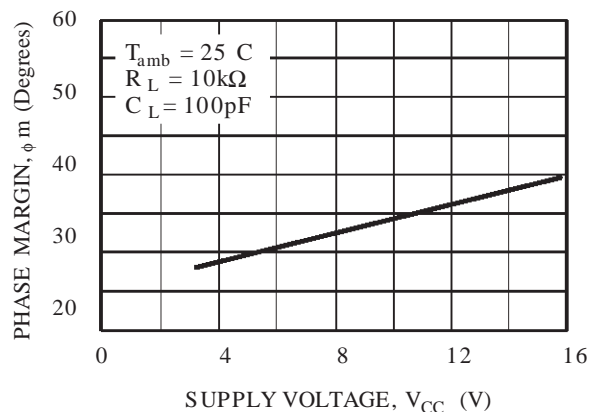
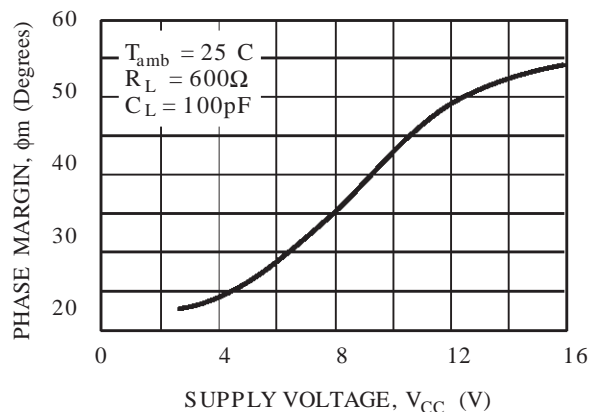
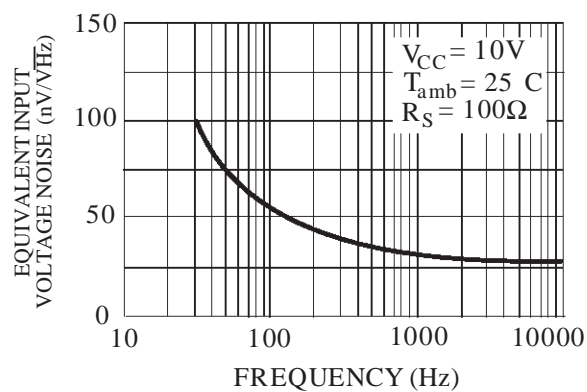

Figure 7b : Phase Margin vs Supply Voltage



**Figure 8 :** Input Voltage Noise vs Frequency





**MACROMODEL**

- RAIL TO RAIL INPUT AND OUTPUT VOLTAGE RANGES
- STANDBY POSITION : REDUCED CONSUMPTION (1 $\mu$ A) AND HIGH IMPEDANCE OUTPUTS
- SINGLE (OR DUAL) SUPPLY OPERATION FROM 2.7V TO 16V ( $\pm$ 1.35V to  $\pm$ 8V)
- EXTREMELY LOW INPUT BIAS CURRENT : 1pA TYP
- LOW INPUT OFFSET VOLTAGE : 1.5mV max.
- SPECIFIED FOR 600 $\Omega$  AND 100 $\Omega$  LOADS
- LOW SUPPLY CURRENT : 400 $\mu$ A/Ampli
- SPEED : 1.3MHz - 1.3V/ $\mu$ s

**Applies to : TS914I,AI,BI**

\*\* Standard Linear Ics Macromodels, 1993.

\*\* CONNECTIONS :

\* 1 INVERTING INPUT

\* 2 NON-INVERTING INPUT

\* 3 OUTPUT

\* 4 POSITIVE POWER SUPPLY

\* 5 NEGATIVE POWER SUPPLY

.SUBCKT TS914\_3 1 3 2 4 5 (analog)

\*\*\*\*\*

.MODEL MDTH D IS=1E-8 KF=6.564344E-14 CJO=10F

\* INPUT STAGE

CIP 2 5 1.000000E-12

CIN 1 5 1.000000E-12

EIP 10 5 2 5 1

EIN 16 5 1 5 1

RIP 10 11 6.500000E+00

RIN 15 16 6.500000E+00

RIS 11 15 1.271505E+01

DIP 11 12 MDTH 400E-12

DIN 15 14 MDTH 400E-12

VOFP 12 13 DC 0.000000E+00

VOFN 13 14 DC 0

IPOL 13 5 4.000000E-05

CPS 11 15 2.125860E-08

DINN 17 13 MDTH 400E-12

VIN 17 5 0.000000E+00

DINR 15 18 MDTH 400E-12

VIP 4 18 0.000000E+00

FCP 4 5 VOFP 5.000000E+00

FCN 5 4 VOFN 5.000000E+00

\* AMPLIFYING STAGE

FIP 5 19 VOFP 2.750000E+02

FIN 5 19 VOFN 2.750000E+02

RG1 19 5 1.916825E+05

RG2 19 4 1.916825E+05

CC 19 29 2.200000E-08

HZTP 30 29 VOFP 1.3E+03

HZTN 5 30 VOFN 1.3E+03

DOPM 19 22 MDTH 400E-12

DONM 21 19 MDTH 400E-12

HOPM 22 28 VOUT 3800

VIPM 28 4 150

HONM 21 27 VOUT 3800

VINM 5 27 150

EOUT 26 23 19 5 1

VOUT 23 5 0

ROUT 26 3 75

COUT 3 5 1.000000E-12

DOP 19 68 MDTH 400E-12

VOP 4 25 1.724

HSCP 68 25 VSCP1 0.8E8

DON 69 19 MDTH 400E-12

VON 24 5 1.7419107

HSCN 24 69 VSCN1 0.8E+08

VSCTHP 60 61 0.0875

\*\* VSCTHP = le seuil au dessus de vio

\* 500

\*\* c.a.d 275U-000U dus a l'offset

DSCP1 61 63 MDTH 400E-12

VSCP1 63 64 0

ISCP 64 0 1.000000E-8

DSCP2 0 64 MDTH 400E-12

DSCN2 0 74 MDTH 400E-12

ISCN 74 0 1.000000E-8

VSCN1 73 74 0

DSCN1 71 73 MDTH 400E-12

VSCTHN 71 70 -0.55

\*\* VSCTHN = le seuil au dessous de vio

\* 2000

\*\* c.a.d -375U-000U dus a l'offset

ESCP 60 0 2 1 500

ESCN 70 0 2 1 -2000

.ENDS

**Applies to : TS914I,AI,BI**

\*\* Standard Linear lcs Macromodels, 1993.

\*\* CONNECTIONS :

\* 1 INVERTING INPUT

\* 2 NON-INVERTING INPUT

\* 3 OUTPUT

\* 4 POSITIVE POWER SUPPLY

\* 5 NEGATIVE POWER SUPPLY

\* 6 STANDBY

.SUBCKT TS914\_5 1 3 2 4 5 (analog)

\*\*\*\*\*

.MODEL MDTH D IS=1E-8 KF=6.564344E-14 CJO=10F

\* INPUT STAGE

CIP 2 5 1.000000E-12

CIN 1 5 1.000000E-12

EIP 10 5 2 5 1

EIN 16 5 1 5 1

RIP 10 11 6.500000E+00

RIN 15 16 6.500000E+00

RIS 11 15 7.322092E+00

DIP 11 12 MDTH 400E-12

DIN 15 14 MDTH 400E-12

VOFP 12 13 DC 0.000000E+00

VOFN 13 14 DC 0

IPOL 13 5 4.000000E-05

CPS 11 15 2.498970E-08

DINN 17 13 MDTH 400E-12

VIN 17 5 0.000000E+00

DINR 15 18 MDTH 400E-12

VIP 4 18 0.000000E+00

FCP 4 5 VOFP 5.750000E+00

FCN 5 4 VOFN 5.750000E+00

ISTB0 5 4 500N

\* AMPLIFYING STAGE

FIP 5 19 VOFP 4.400000E+02

FIN 5 19 VOFN 4.400000E+02

RG1 19 5 4.904961E+05

RG2 19 4 4.904961E+05

CC 19 29 2.200000E-08

HZTP 30 29 VOFP 1.8E+03

HZTN 5 30 VOFN 1.8E+03

DOPM 19 22 MDTH 400E-12

DONM 21 19 MDTH 400E-12

HOPM 22 28 VOUT 3800

VIPM 28 4 230

HONM 21 27 VOUT 3800

VINM 5 27 230

EOUT 26 23 19 5 1

VOUT 23 5 0

ROUT 26 3 82

COUT 3 5 1.000000E-12

DOP 19 68 MDTH 400E-12

VOP 4 25 1.724

HSCP 68 25

VSCP1 0.8E+08

DON 69 19 MDTH 400E-12

VON 24 5 1.7419107

HSCN 24 69

VSCN1 0.8E+08

VSCTHP 60 61 0.0875

\*\* VSCTHP = le seuil au dessus de vio

\* 500

\*\* c.a.d 275U-000U dus a l'offset

DSCP1 61 63 MDTH 400E-12

VSCP1 63 64 0

ISCP 64 0 1.000000E-8

DSCP2 0 64 MDTH 400E-12

DSCN2 0 74 MDTH 400E-12

ISCN 74 0 1.000000E-8

VSCN1 73 74 0

DSCN1 71 73 MDTH 400E-12

VSCTHN 71 70 -0.55

\*\* VSCTHN = le seuil au dessous de vio

\* 2000

\*\* c.a.d -375U-000U dus a l'offset

ESCP 60 0 2 1 500

ESCN 70 0 2 1 -2000

.ENDS

**ELECTRICAL CHARACTERISTICS**

$V_{CC}^+ = 3V$ ,  $V_{CC}^- = 0V$ ,  $R_L, C_L$  connected to  $V_{CC}/2$ ,  $T_{amb} = 25^\circ C$   
(unless otherwise specified)

Symbol	Conditions	Value	Unit
$V_{io}$		0	mV
$A_{vd}$	$R_L = 10k\Omega$	10	V/mV
$I_{CC}$	No load, per operator	100	$\mu A$
$V_{icm}$		-0.2 to 3.2	V
$V_{OH}$	$R_L = 600\Omega$	2.6	V
$V_{OL}$	$R_L = 600\Omega$	300	mV
$I_{sink}$	$V_O = 3V$	40	mA
$I_{source}$	$V_O = 0V$	40	mA
GBP	$R_L = 10k\Omega$ , $C_L = 100pF$ , $F = 100kHz$	0.8	MHz
SR	$R_L = 10k\Omega$ , $C_L = 100pF$	0.5	V/ $\mu s$
$\theta_m$		30	Degrees

**PACKAGE MECHANICAL DATA**

14 PINS - PLASTIC DIP

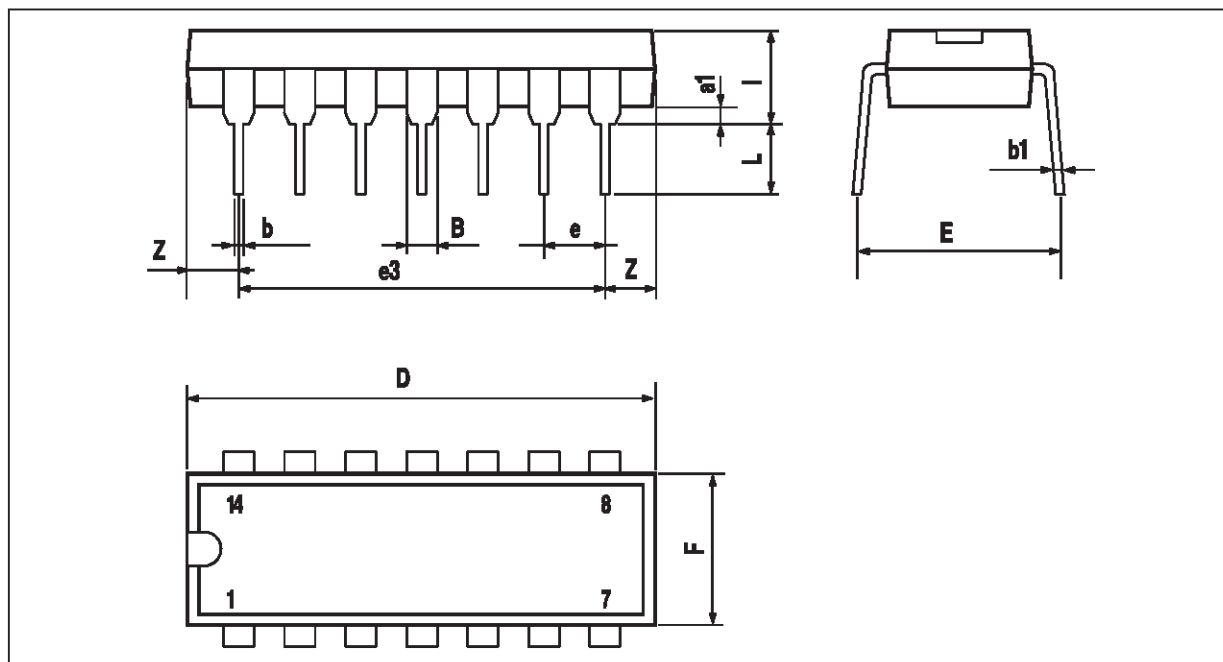

Dimensions	Millimeters			Inches		
	Min.	Typ.	Max.	Min.	Typ.	Max.
a1	0.51			0.020		
B	1.39		1.65	0.055		0.065
b		0.5			0.020	
b1		0.25			0.010	
D			20			0.787
E		8.5			0.335	
e		2.54			0.100	
e3		15.24			0.600	
F			7.1			0.280
i			5.1			0.201
L		3.3			0.130	
Z	1.27		2.54	0.050		0.100

**PACKAGE MECHANICAL DATA**

14 PINS - PLASTIC MICROPACKAGE (so)

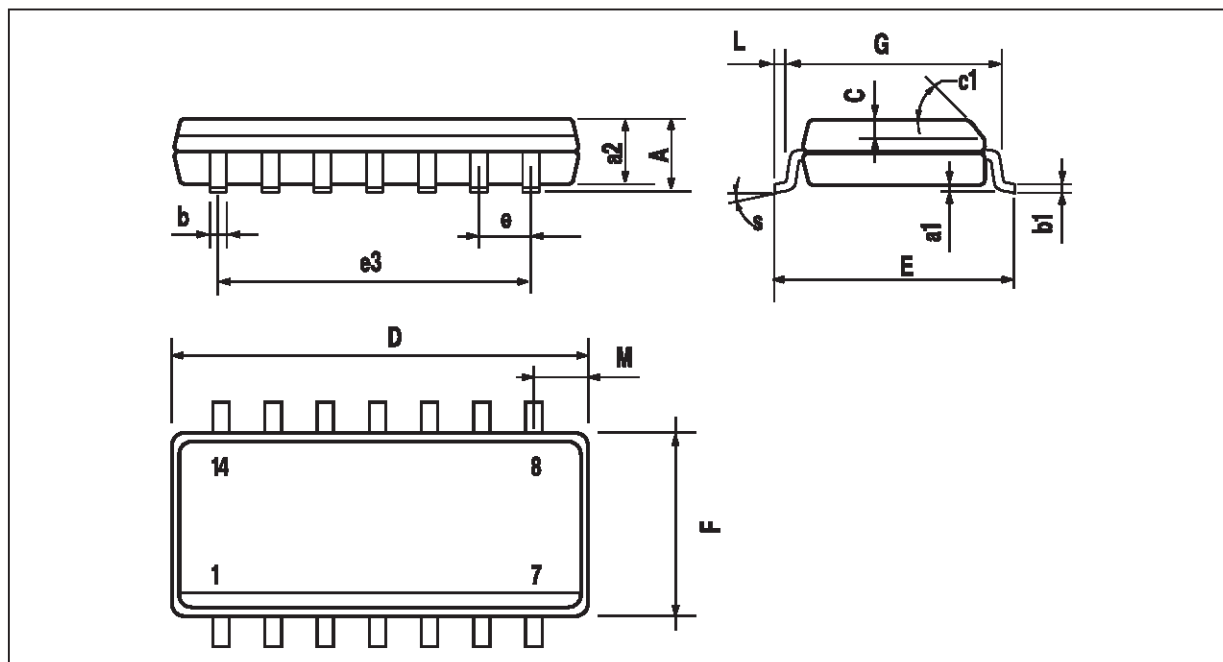

Dimensions	Millimeters			Inches		
	Min.	Typ.	Max.	Min.	Typ.	Max.
A			1.75			0.069
a1	0.1		0.2	0.004		0.008
a2			1.6			0.063
b	0.35		0.46	0.014		0.018
b1	0.19		0.25	0.007		0.010
C		0.5			0.020	
c1	45° (typ.)					
D	8.55		8.75	0.336		0.334
E	5.8		6.2	0.228		0.244
e		1.27			0.050	
e3		7.62			0.300	
F	3.8		4.0	0.150		0.157
G	4.6		5.3	0.181		0.208
L	0.5		1.27	0.020		0.050
M			0.68			0.027
S	8° (max.)					

Information furnished is believed to be accurate and reliable. However, STMicroelectronics assumes no responsibility for the consequences of use of such information nor for any infringement of patents or other rights of third parties which may result from its use. No license is granted by implication or otherwise under any patent or patent rights of STMicroelectronics. Specifications mentioned in this publication are subject to change without notice. This publication supersedes and replaces all information previously supplied. STMicroelectronics products are not authorized for use as critical components in life support devices or systems without express written approval of STMicroelectronics.

© The ST logo is a trademark of STMicroelectronics

© 1999 STMicroelectronics – Printed in Italy – All Rights Reserved

STMicroelectronics GROUP OF COMPANIES

Australia - Brazil - Canada - China - France - Germany - Italy - Japan - Korea - Malaysia - Malta - Mexico - Morocco  
The Netherlands - Singapore - Spain - Sweden - Switzerland - Taiwan - Thailand - United Kingdom - U.S.A.

© <http://www.st.com>



This datasheet has been downloaded from:

[www.DatasheetCatalog.com](http://www.DatasheetCatalog.com)

Datasheets for electronic components.