

TLPGE18TP, TLFGE18TP, TLGE18TP, TLPYE18TP

Panel Circuit Indicator

Unit: mm

- 5 mm package
- InGaAlP technology
- All plastic mold type
- Transparent lens
- Line-up: 3 colors (pure green, green, pure yellow)
- High intensity light emission
- Excellent low current light output
- Stopper lead type is also available
TLPGE18T, TLFGE18T, TLGE18T, TLPYE18T
- Applications: outdoor message signboards, safety equipment, backlight, etc.

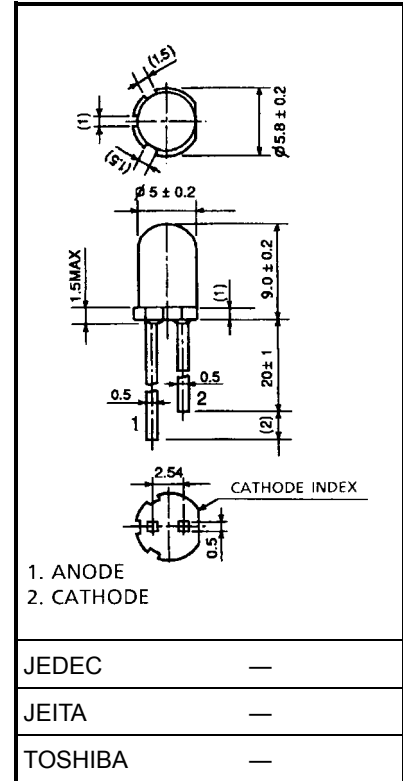

Weight: 0.31 g

Line-up

Product Name	Color	Material
TLPGE18TP	Pure Green	InGaAlP
TLFGE18TP	Green	
TLGE18TP	Green	
TLPYE18TP	Pure Yellow	

Maximum Ratings (Ta = 25°C)

Product Name	Forward Current I _F (mA)	Reverse Voltage V _R (V)	Power Dissipation P _D (mW)	Operating Temperature T _{opr} (°C)	Storage Temperature T _{stg} (°C)
TLPGE18TP	50	4	120	-40~100	-40~120
TLFGE18TP	50	4	120		
TLGE18TP	50	4	120		
TLPYE18TP	50	4	120		

Electrical and Optical Characteristics (Ta = 25°C)

Product Name	Typ. Emission Wavelength				Luminous Intensity I _V			Forward Voltage V _F			Reverse Current I _R	
	λ _d	λ _p	Δλ	I _F	Min	Typ.	I _F	Typ.	Max	I _F	Max	V _R
TLPGE18TP	558	(562)	14	20	85	200	20	2.1	2.4	20	50	4
TLFGE18TP	565	(568)	15	20	85	300	20	2.0	2.4	20	50	4
TLGE18TP	571	(574)	17	20	272	700	20	2.0	2.4	20	50	4
TLPYE18TP	580	(583)	14	20	272	750	20	2.0	2.4	20	50	4
Unit	nm			mA	mcd		mA	V		mA	μA	V

Precautions

Please be careful of the following:

- Soldering temperature: 260°C max, soldering time: 3 s max
(soldering portion of lead: up to 2 mm from the body of the device)
- If the lead is formed, the lead should be formed up to 5 mm from the body of the device without forming stress to the resin. Soldering should be performed after lead forming.
- This visible LED lamp also emits some IR light.
If a photodetector is located near the LED lamp, please ensure that it will not be affected by this IR light.

TLPGE18TP

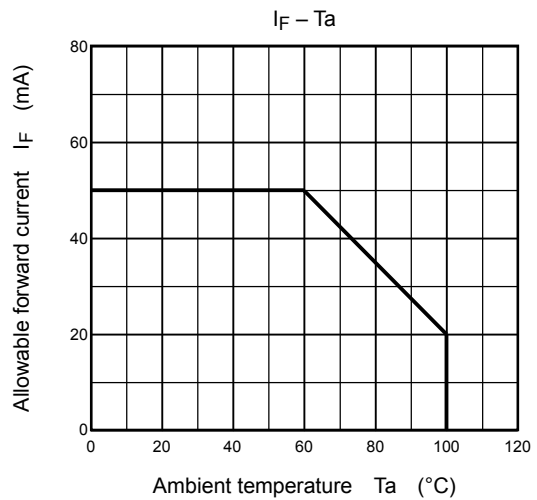
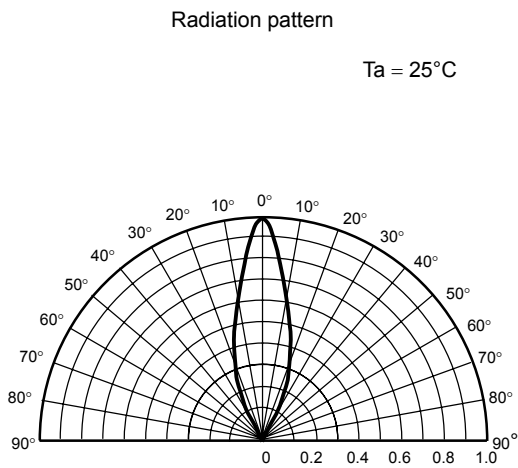
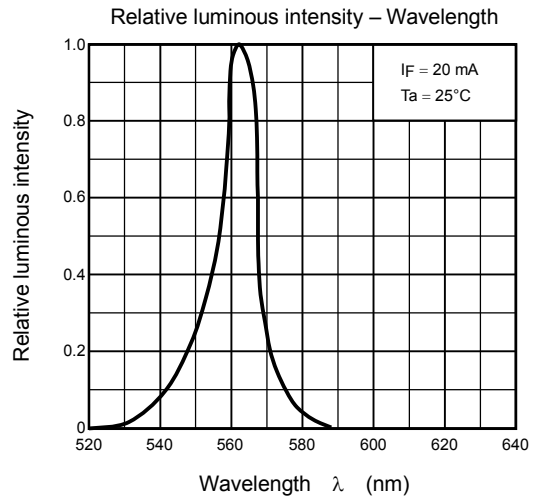
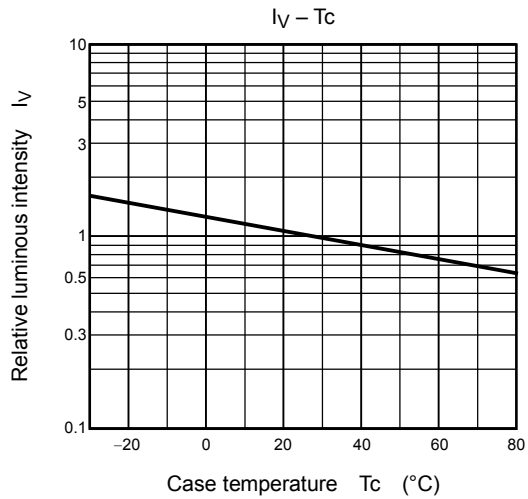
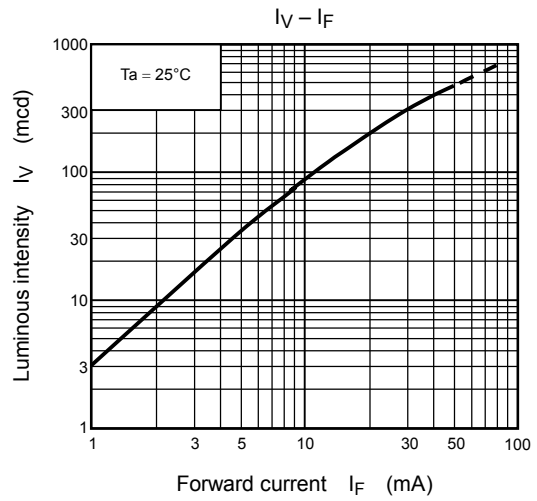
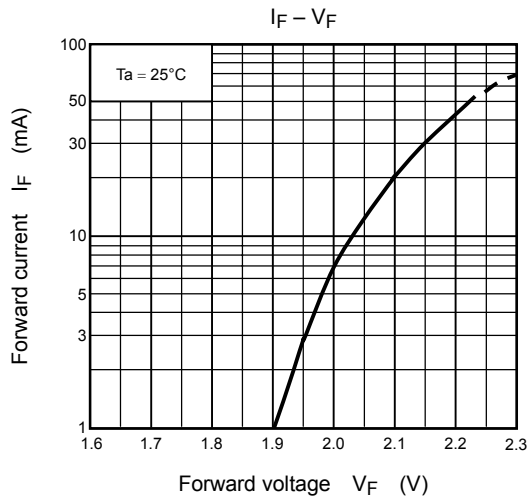

TLFGE18TP

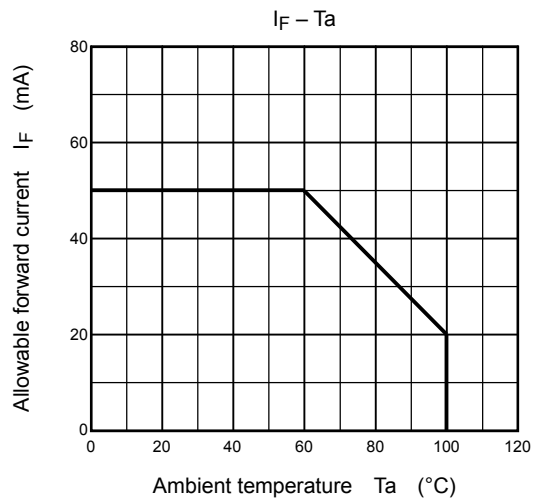
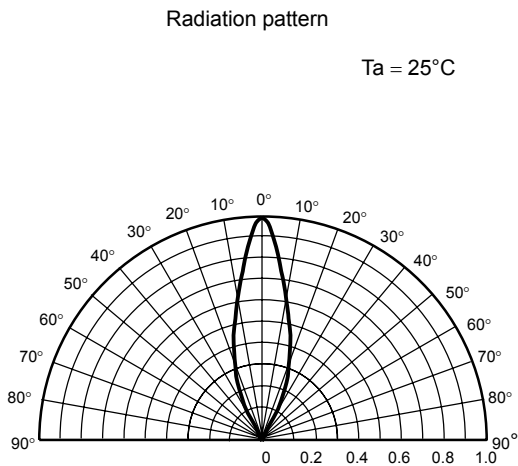
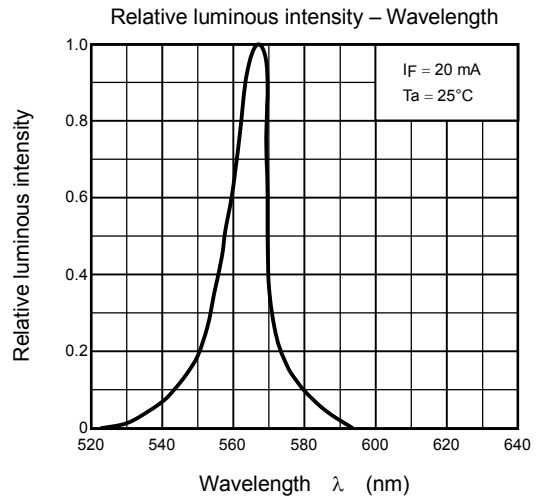
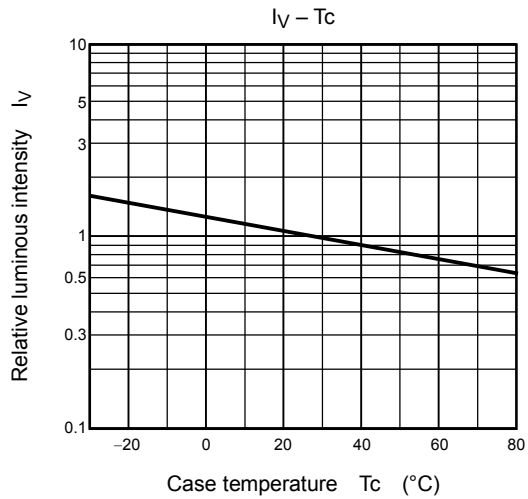
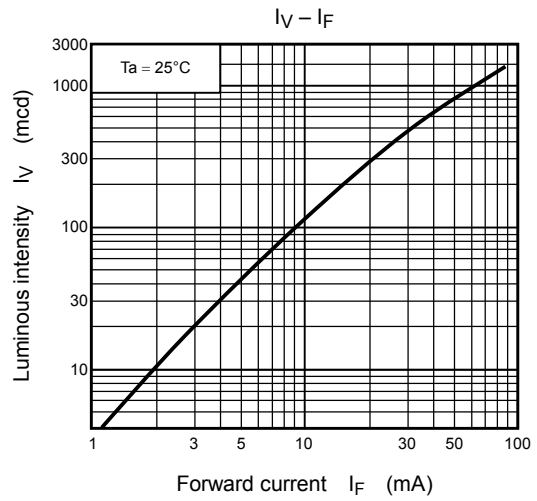
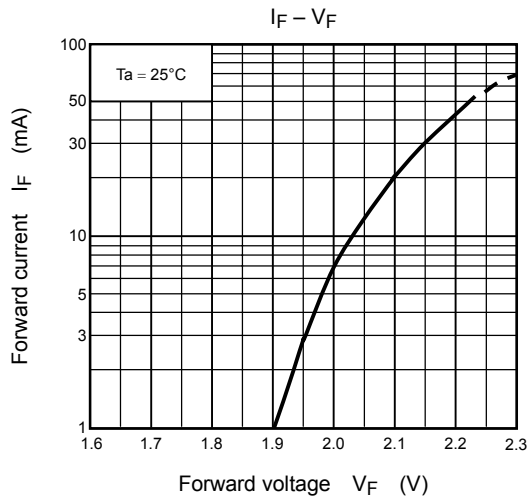

TLGE18TP

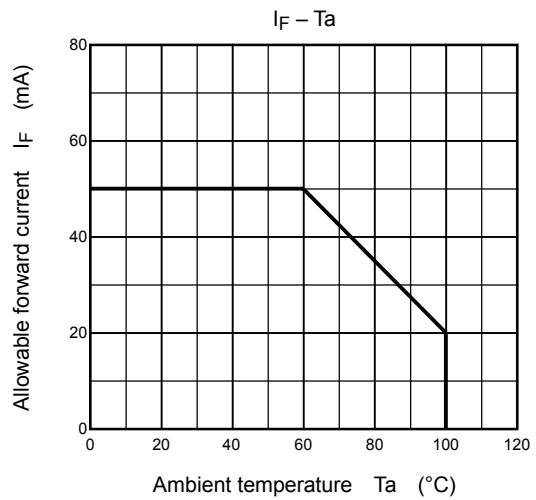
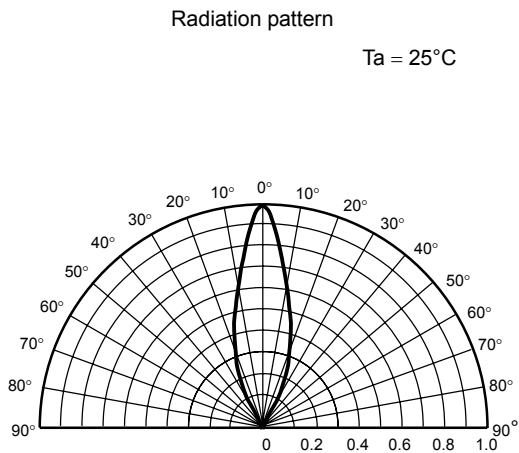
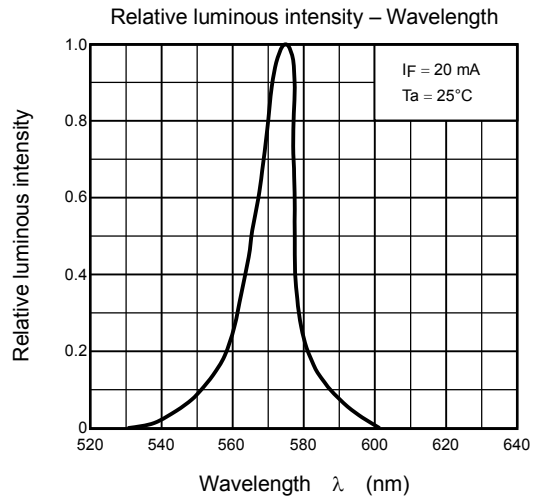
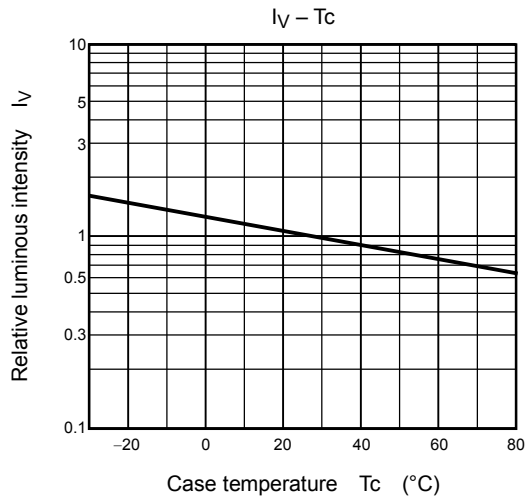
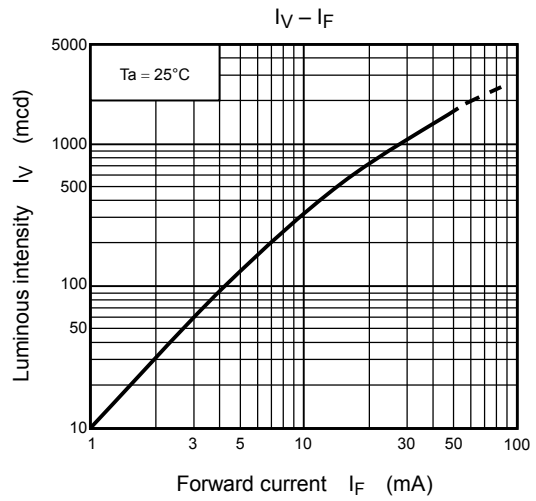
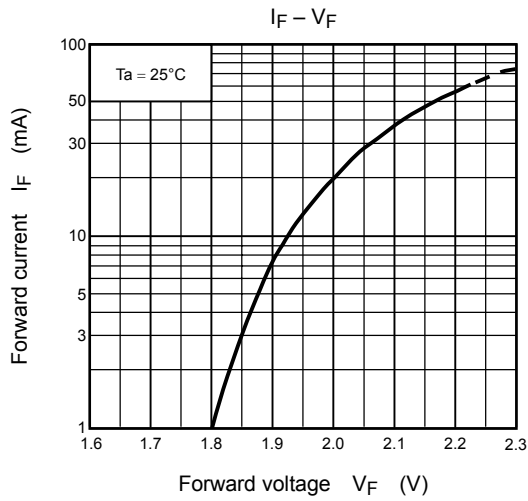

TLPYE18TP

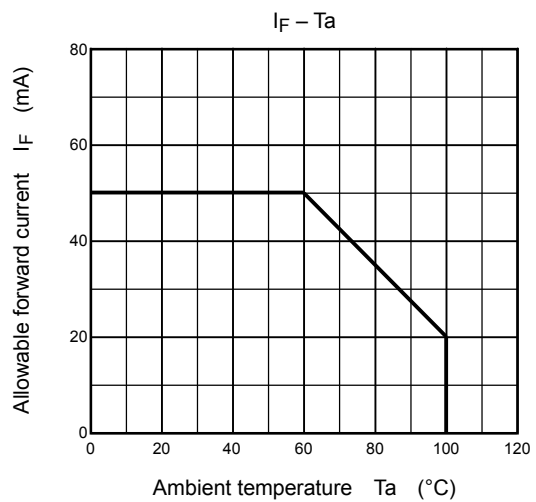
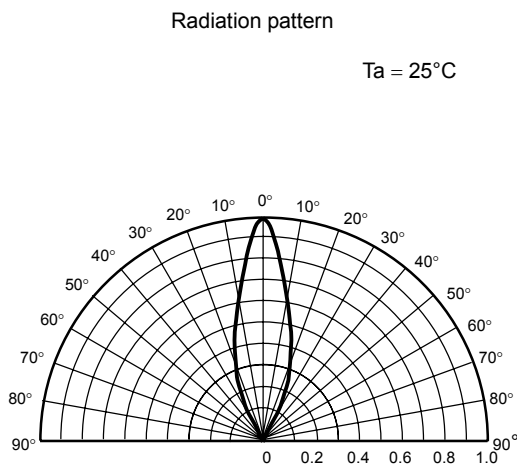
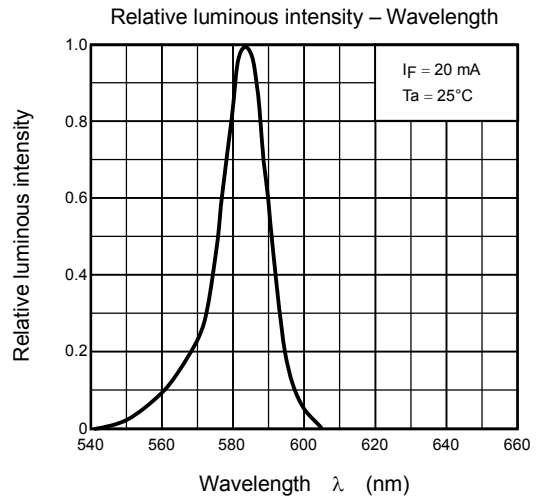
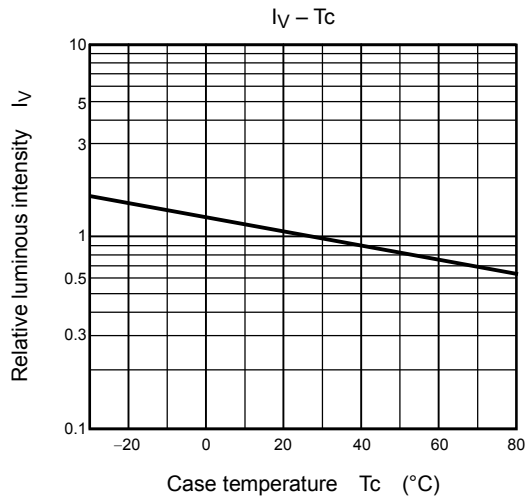
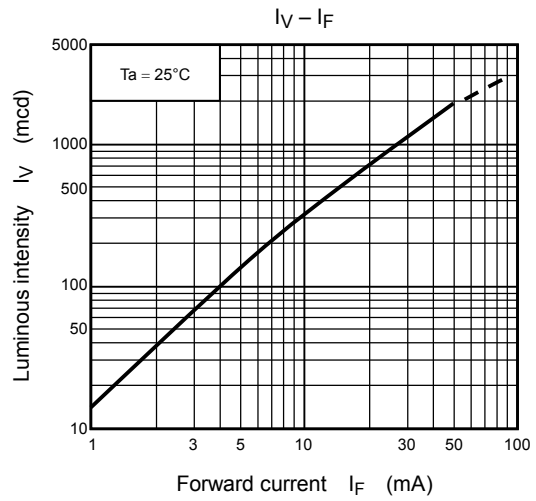
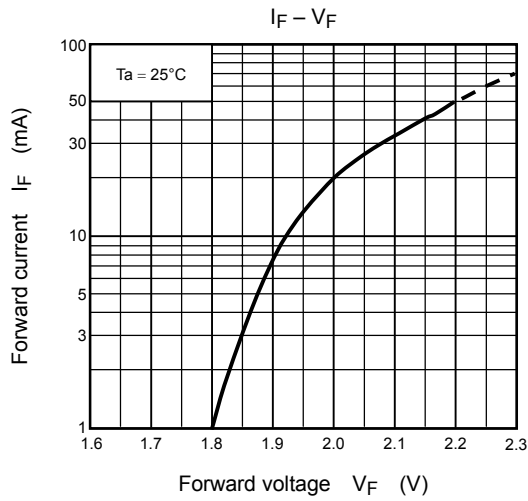

RESTRICTIONS ON PRODUCT USE

000707EAC

- TOSHIBA is continually working to improve the quality and reliability of its products. Nevertheless, semiconductor devices in general can malfunction or fail due to their inherent electrical sensitivity and vulnerability to physical stress. It is the responsibility of the buyer, when utilizing TOSHIBA products, to comply with the standards of safety in making a safe design for the entire system, and to avoid situations in which a malfunction or failure of such TOSHIBA products could cause loss of human life, bodily injury or damage to property.
In developing your designs, please ensure that TOSHIBA products are used within specified operating ranges as set forth in the most recent TOSHIBA products specifications. Also, please keep in mind the precautions and conditions set forth in the "Handling Guide for Semiconductor Devices," or "TOSHIBA Semiconductor Reliability Handbook" etc..
- The TOSHIBA products listed in this document are intended for usage in general electronics applications (computer, personal equipment, office equipment, measuring equipment, industrial robotics, domestic appliances, etc.). These TOSHIBA products are neither intended nor warranted for usage in equipment that requires extraordinarily high quality and/or reliability or a malfunction or failure of which may cause loss of human life or bodily injury ("Unintended Usage"). Unintended Usage include atomic energy control instruments, airplane or spaceship instruments, transportation instruments, traffic signal instruments, combustion control instruments, medical instruments, all types of safety devices, etc.. Unintended Usage of TOSHIBA products listed in this document shall be made at the customer's own risk.
- Gallium arsenide (GaAs) is a substance used in the products described in this document. GaAs dust and fumes are toxic. Do not break, cut or pulverize the product, or use chemicals to dissolve them. When disposing of the products, follow the appropriate regulations. Do not dispose of the products with other industrial waste or with domestic garbage.
- The information contained herein is presented only as a guide for the applications of our products. No responsibility is assumed by TOSHIBA CORPORATION for any infringements of intellectual property or other rights of the third parties which may result from its use. No license is granted by implication or otherwise under any intellectual property or other rights of TOSHIBA CORPORATION or others.
- The information contained herein is subject to change without notice.

This datasheet has been download from:

www.datasheetcatalog.com

Datasheets for electronics components.