

74LVT16245 • 74LVTH16245

Low Voltage 16-Bit Transceiver with 3-STATE Outputs

General Description

The LVT16245 and LVTH16245 contain sixteen non-inverting bidirectional buffers with 3-STATE outputs and is intended for bus oriented applications. The device is byte controlled. Each byte has separate control inputs which can be shorted together for full 16-bit operation. The T/R inputs determine the direction of data flow through the device. The OE inputs disable both the A and B ports by placing them in a high impedance state.

The LVTH16245 data inputs include bushold, eliminating the need for external pull-up resistors to hold unused inputs.

These non-inverting transceivers are designed for low-voltage (3.3V) V_{CC} applications, but with the capability to provide a TTL interface to a 5V environment. The LVT16245 and LVTH16245 are fabricated with an advanced BiCMOS technology to achieve high speed operation similar to 5V ABT while maintaining low power dissipation.

Features

- Input and output interface capability to systems at 5V V_{CC}
- Bushold data inputs eliminate the need for external pull-up resistors to hold unused inputs (74LVTH16245), also available without bushold feature (74LVT16245).
- Live insertion/extraction permitted
- Power Up/Down high impedance provides glitch-free bus loading
- Outputs source/sink -32 mA/+64 mA
- Functionally compatible with the 74 series 16245
- Latch-up performance exceeds 500 mA
- ESD performance:
 - Human-body model >2000V
 - Machine model >200V
 - Charged-device >1000V
- Also packaged in plastic Fine-Pitch Ball Grid Array (FBGA) (Preliminary)

Ordering Code:

Order Number	Package Number	Package Description
74LVT16245GX (Note 1)	BGA54A (Preliminary)	54-Ball Fine-Pitch Ball Grid Array (FBGA), JEDEC MO-205, 5.5mm Wide [Tape and Reel]
74LVT16245MEA (Note 2)	MS48A	48-Lead Small Shrink Outline Package (SSOP), JEDEC MO-118, 0.300" Wide
74LVT16245MTD (Note 2)	MTD48	48-Lead Thin Shrink Small Outline Package (TSSOP), JEDEC MO-153, 6.1mm Wide
74LVTH16245GX (Note 1)	BGA54A (Preliminary)	54-Ball Fine-Pitch Ball Grid Array (FBGA), JEDEC MO-205, 5.5mm Wide [Tape and Reel]
74LVTH16245MEA (Note 2)	MS48A	48-Lead Small Shrink Outline Package (SSOP), JEDEC MO-118, 0.300" Wide
74LVTH16245MTD (Note 2)	MTD48	48-Lead Thin Shrink Small Outline Package (TSSOP), JEDEC MO-153, 6.1mm Wide

Note 1: BGA package available in Tape and Reel only.

Note 2: Devices also available in Tape and Reel. Specify by appending suffix letter "X" to the ordering code.

Logic Symbol

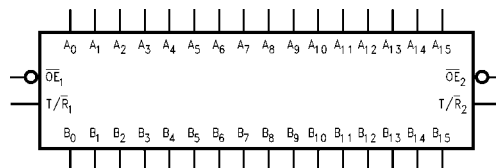

Connection Diagrams

Pin Assignment for SSOP and TSSOP

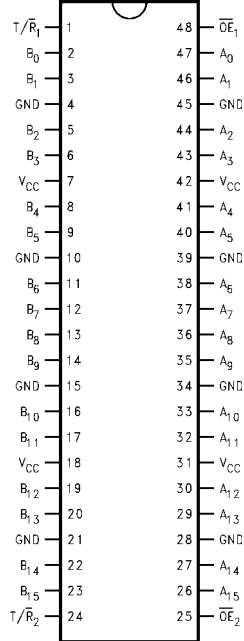

Pin Assignment for FBGA

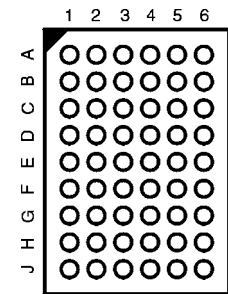

(Top Thru View)

Pin Descriptions

Pin Names	Description
\overline{OE}_n	Output Enable Input (Active LOW)
T/\overline{R}_n	Transmit/Receive Input
A_0-A_{15}	Side A Inputs/3-STATE Outputs
B_0-B_{15}	Side B Inputs/3-STATE Outputs
NC	No Connect

FBGA Pin Assignments

	1	2	3	4	5	6
A	B ₀	NC	T/\overline{R}_1	\overline{OE}_1	NC	A ₀
B	B ₂	B ₁	NC	NC	A ₁	A ₂
C	B ₄	B ₃	V _{CC}	V _{CC}	A ₃	A ₄
D	B ₆	B ₅	GND	GND	A ₅	A ₆
E	B ₈	B ₇	GND	GND	A ₇	A ₈
F	B ₁₀	B ₉	GND	GND	A ₉	A ₁₀
G	B ₁₂	B ₁₁	V _{CC}	V _{CC}	A ₁₁	A ₁₂
H	B ₁₄	B ₁₃	NC	NC	A ₁₃	A ₁₄
J	B ₁₅	NC	T/\overline{R}_2	\overline{OE}_2	NC	A ₁₅

Truth Tables

Inputs		Outputs
\overline{OE}_1	T/\overline{R}_1	
L	L	Bus B ₀ -B ₇ Data to Bus A ₀ -A ₇
L	H	Bus A ₀ -A ₇ Data to Bus B ₀ -B ₇
H	X	HIGH-Z State on A ₀ -A ₇ , B ₀ -B ₇

Inputs		Outputs
\overline{OE}_2	T/\overline{R}_2	
L	L	Bus B ₈ -B ₁₅ Data to Bus A ₈ -A ₁₅
L	H	Bus A ₈ -A ₁₅ Data to Bus B ₈ -B ₁₅
H	X	HIGH-Z State on A ₈ -A ₁₅ , B ₈ -B ₁₅

H = HIGH Voltage Level
 L = LOW Voltage Level
 X = Immaterial
 Z = High Impedance

Functional Description

The LVT16245 and LVTH16245 contain sixteen non-inverting bidirectional buffers with 3-STATE outputs. The device is byte controlled with each byte functioning identically, but independent of the other. The control pins can be shorted together to obtain full 16-bit operation.

Logic Diagrams

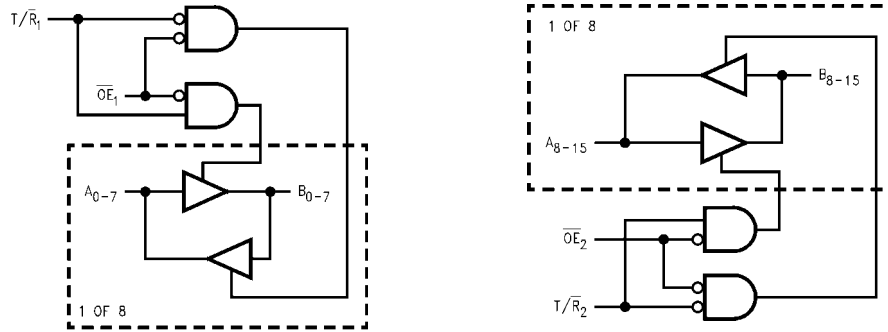

Note: Please note that these diagrams are provided only for the understanding of logic operations and should not be used to estimate propagation delays.

Absolute Maximum Ratings (Note 3)					
Symbol	Parameter	Value	Conditions		Units
V_{CC}	Supply Voltage	-0.5 to +4.6			V
V_I	DC Input Voltage	-0.5 to +7.0			V
V_O	Output Voltage	-0.5 to +7.0	Output in 3-STATE		V
		-0.5 to +7.0	Output in HIGH or LOW State (Note 4)		
I_{IK}	DC Input Diode Current	-50	$V_I < \text{GND}$		mA
I_{OK}	DC Output Diode Current	-50	$V_O < \text{GND}$		mA
I_O	DC Output Current	64	Output at HIGH State, $V_O > V_{CC}$		mA
		128	Output at LOW State, $V_O > V_{CC}$		
I_{CC}	DC Supply Current per Supply Pin	± 64			mA
I_{GND}	DC Ground Current per Ground Pin	± 128			mA
T_{STG}	Storage Temperature Range	-65 to +150			$^{\circ}\text{C}$

Recommended Operating Conditions					
Symbol	Parameter	Min	Max	Units	
V_{CC}	Supply Voltage	2.7	3.6	V	
V_I	Input Voltage	0	5.5	V	
I_{OH}	HIGH-Level Output Current		-32	mA	
I_{OL}	LOW-Level Output Current		64	mA	
T_A	Free-Air Operating Temperature	-40	+85	$^{\circ}\text{C}$	
$\Delta t/\Delta V$	Input Edge Rate, $V_{IN} = 0.8\text{V}-2.0\text{V}$, $V_{CC} = 3.0\text{V}$	0	10	ns/V	

Note 3: Absolute Maximum continuous ratings are those values beyond which damage to the device may occur. Exposure to these conditions or conditions beyond those indicated may adversely affect device reliability. Functional operation under absolute maximum rated conditions is not implied.

Note 4: I_O Absolute Maximum Ratings must be observed.

DC Electrical Characteristics							
Symbol	Parameter	V_{CC} (V)	$T_A = -40^{\circ}\text{C}$ to $+85^{\circ}\text{C}$		Units	Conditions	
			Min	Max			
V_{IK}	Input Clamp Diode Voltage	2.7		-1.2	V	$I_I = -18\text{ mA}$	
V_{IH}	Input HIGH Voltage	2.7-3.6	2.0		V	$V_O \leq 0.1\text{V}$ or $V_O \geq V_{CC} - 0.1\text{V}$	
V_{IL}	Input LOW Voltage	2.7-3.6		0.8	V		
V_{OH}	Output HIGH Voltage	2.7-3.6	$V_{CC} - 0.2$		V	$I_{OH} = -100\ \mu\text{A}$	
		2.7	2.4			$I_{OH} = -8\text{ mA}$	
		3.0	2.0			$I_{OH} = -32\text{ mA}$	
V_{OL}	Output LOW Voltage	2.7		0.2	V	$I_{OL} = 100\ \mu\text{A}$	
		2.7		0.5		$I_{OL} = 24\text{ mA}$	
		3.0		0.4		$I_{OL} = 16\text{ mA}$	
		3.0		0.5		$I_{OL} = 32\text{ mA}$	
		3.0		0.55		$I_{OL} = 64\text{ mA}$	
$I_{I(\text{HOLD})}$ (Note 5)	Bushold Input Minimum Drive	3.0	75		μA	$V_I = 0.8\text{V}$	
			-75			$V_I = 2.0\text{V}$	
$I_{I(\text{OD})}$ (Note 5)	Bushold Input Over-Drive Current to Change State	3.0	500		μA	(Note 6)	
			-500			(Note 7)	
I_I	Input Current	3.6		10	μA	$V_I = 5.5\text{V}$	
		Control Pins	3.6			± 1	$V_I = 0\text{V}$ or V_{CC}
			Data Pins	3.6			-5
				1		$V_I = V_{CC}$	
I_{OFF}	Power Off Leakage Current	0		± 100	μA	$0\text{V} \leq V_I$ or $V_O \leq 5.5\text{V}$	
$I_{PU/PD}$	Power Up/Down 3-STATE Output Current	0-1.5		± 100	μA	$V_O = 0.5\text{V}$ to 3.0V $V_I = \text{GND}$ or V_{CC}	
I_{OZL}	3-STATE Output Leakage Current	3.6		-5	μA	$V_O = 0.5\text{V}$	
I_{OZL} (Note 5)	3-STATE Output Leakage Current	3.6		-5	μA	$V_O = 0.0\text{V}$	

DC Electrical Characteristics (Continued)							
Symbol	Parameter	V _{CC} (V)	T _A = -40°C to +85°C		Units	Conditions	
			Min	Max			
I _{OZH}	3-STATE Output Leakage Current	3.6		5	μA	V _O = 3.0V	
I _{OZH} (Note 5)	3-STATE Output Leakage Current	3.6		5	μA	V _O = 3.6V	
I _{OZH+}	3-STATE Output Leakage Current	3.6		10	μA	V _{CC} < V _O ≤ 5.5V	
I _{CCH}	Power Supply Current	3.6		0.19	mA	Outputs HIGH	
I _{CCL}	Power Supply Current	3.6		5.0	mA	Outputs LOW	
I _{CCZ}	Power Supply Current	3.6		0.19	mA	Outputs Disabled	
I _{CCZ+}	Power Supply Current	3.6		0.19	mA	V _{CC} ≤ V _O ≤ 5.5V, Outputs Disabled	
ΔI _{CC} (Note 8)	Increase in Power Supply Current	3.6		0.2	mA	One Input at V _{CC} - 0.6V Other Inputs at V _{CC} or GND	
<p>Note 5: Applies to bushold versions only (74LVTH16245).</p> <p>Note 6: An external driver must source at least the specified current to switch from LOW-to-HIGH.</p> <p>Note 7: An external driver must sink at least the specified current to switch from HIGH-to-LOW.</p> <p>Note 8: This is the increase in supply current for each input that is at the specified voltage level rather than V_{CC} or GND.</p>							
Dynamic Switching Characteristics (Note 9)							
Symbol	Parameter	V _{CC} (V)	T _A = 25°C			Units	Conditions C _L = 50 pF, R _L = 500Ω
			Min	Typ	Max		
V _{OLP}	Quiet Output Maximum Dynamic V _{OL}	3.3		0.8		V	(Note 10)
V _{OLV}	Quiet Output Minimum Dynamic V _{OL}	3.3		-0.8		V	(Note 10)
<p>Note 9: Characterized in SSOP package. Guaranteed parameter, but not tested.</p> <p>Note 10: Max number of outputs defined as (n). n-1 data inputs are driven 0V to 3V. Output under test held LOW.</p>							
AC Electrical Characteristics							
Symbol	Parameter	T _A = -40°C to +85°C C _L = 50 pF, R _L = 500Ω				Units	
		V _{CC} = 3.3V ± 0.3V		V _{CC} = 2.7V			
		Min	Max	Min	Max		
t _{PLH}	Propagation Delay Data to Output	1.5	3.5	1.5	3.9	ns	
t _{PHL}		1.3	3.5	1.3	3.9		
t _{PZH}	Output Enable Time	1.5	4.5	1.5	5.3	ns	
t _{PZL}		1.6	5.3	1.6	6.9		
t _{PHZ}	Output Disable Time	2.3	5.4	2.3	6.1	ns	
t _{PLZ}		2.2	5.1	2.2	5.4		
t _{OSSL}	Output to Output Skew (Note 11)		1.0		1.0	ns	
t _{OSLH}							
<p>Note 11: Skew is defined as the absolute value of the difference between the actual propagation delay for any two separate outputs of the same device. The specification applies to any outputs switching in the same direction, either HIGH-to-LOW (t_{OSSL}) or LOW-to-HIGH (t_{OSLH}). Parameter guaranteed by design.</p>							
Capacitance (Note 12)							
Symbol	Parameter	Conditions		Typical	Units		
C _{IN}	Input Capacitance	V _{CC} = 0V, V _I = 0V or V _{CC}		4	pF		
C _{I/O}	Input/Output Capacitance	V _{CC} = 3.0V, V _O = 0V or V _{CC}		8	pF		
<p>Note 12: Capacitance is measured at frequency f = 1 MHz, per MIL-STD-883, Method 3012.</p>							

Physical Dimensions inches (millimeters) unless otherwise noted

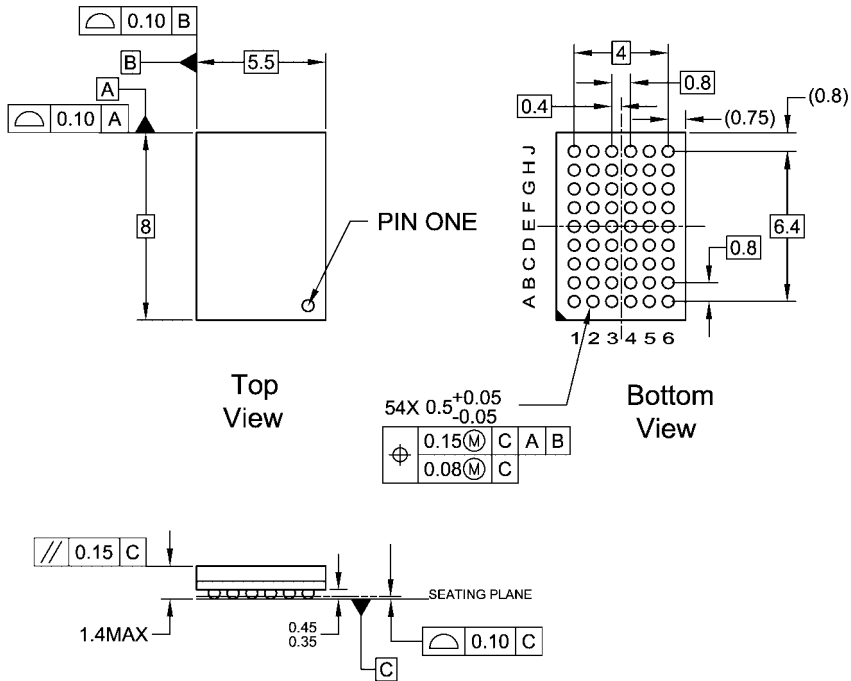

NOTES:

- A. THIS PACKAGE CONFORMS TO JEDEC M0-205
- B. ALL DIMENSIONS IN MILLIMETERS
- C. LAND PATTERN RECOMMENDATION: NSMD (Non Solder Mask Defined)
.35MM DIA PADS WITH A SOLDERMASK OPENING OF .45MM CONCENTRIC TO PADS
- D. DRAWING CONFORMS TO ASME Y14.5M-1994

BGA54ArevD

**54-Ball Fine-Pitch Ball Grid Array (FBGA), JEDEC MO-205, 5.5mm Wide
Package Number BGA54A
Preliminary**

Physical Dimensions inches (millimeters) unless otherwise noted (Continued)

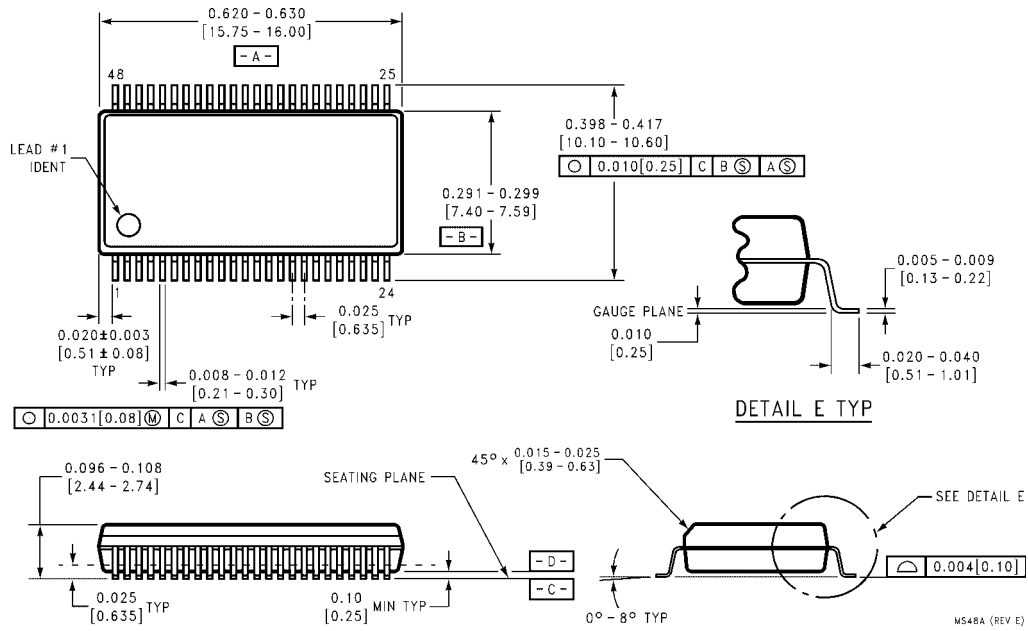

**48-Lead Small Shrink Outline Package (SSOP), JEDEC MO-118, 0.300" Wide
Package Number MS48A**

Physical Dimensions inches (millimeters) unless otherwise noted (Continued)

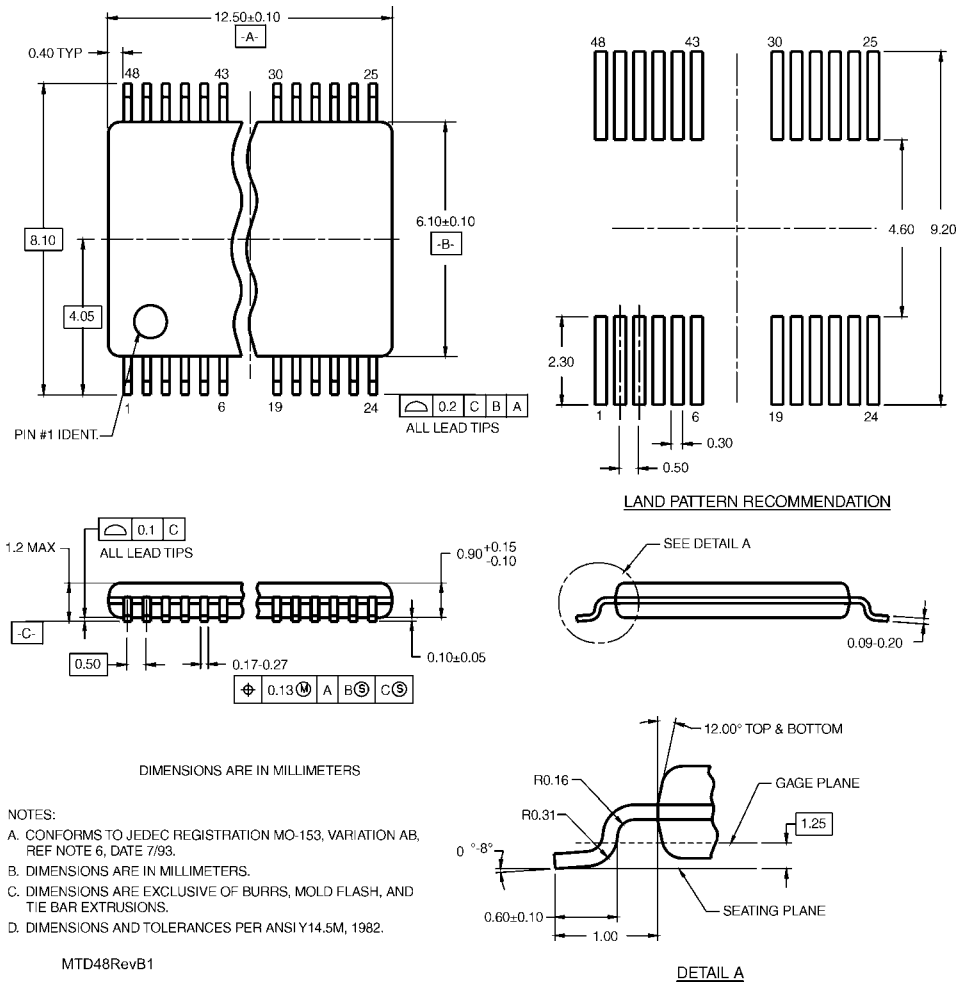

DIMENSIONS ARE IN MILLIMETERS

- NOTES:
- A. CONFORMS TO JEDEC REGISTRATION MO-153, VARIATION AB, REF NOTE 6, DATE 7/93.
 - B. DIMENSIONS ARE IN MILLIMETERS.
 - C. DIMENSIONS ARE EXCLUSIVE OF BURRS, MOLD FLASH, AND TIE BAR EXTRUSIONS.
 - D. DIMENSIONS AND TOLERANCES PER ANSYI 14.5M, 1982.

MTD48RevB1

48-Lead Thin Shrink Small Outline Package (TSSOP), JEDEC MO-153, 6.1mm Wide Package Number MTD48

Fairchild does not assume any responsibility for use of any circuitry described, no circuit patent licenses are implied and Fairchild reserves the right at any time without notice to change said circuitry and specifications.

LIFE SUPPORT POLICY

FAIRCHILD'S PRODUCTS ARE NOT AUTHORIZED FOR USE AS CRITICAL COMPONENTS IN LIFE SUPPORT DEVICES OR SYSTEMS WITHOUT THE EXPRESS WRITTEN APPROVAL OF THE PRESIDENT OF FAIRCHILD SEMICONDUCTOR CORPORATION. As used herein:

1. Life support devices or systems are devices or systems which, (a) are intended for surgical implant into the body, or (b) support or sustain life, and (c) whose failure to perform when properly used in accordance with instructions for use provided in the labeling, can be reasonably expected to result in a significant injury to the user.
2. A critical component in any component of a life support device or system whose failure to perform can be reasonably expected to cause the failure of the life support device or system, or to affect its safety or effectiveness.

www.fairchildsemi.com

This datasheet has been download from:

www.datasheetcatalog.com

Datasheets for electronics components.