

## 0.5W High Power Laser Diode

**Description**

The SLD322XT is a high power, gain-guided laser diode produced by MOCVD method\*1. Compared to the SLD300 Series, this laser diode has a high brightness output with a doubled optical density which can be achieved by QW-SCH structure\*2.

Fine adjustment of the oscillation wavelength is possible by controlling the temperature using the built-in TE cooler (Peltier element).

\*1 MOCVD: Metal Organic Chemical Vapor Deposition

\*2 QW-SCH: Quantum Well Separate Confinement Heterostructure

**Equivalent Circuit**

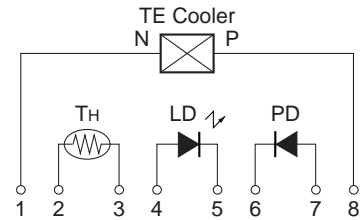

**Features**

- High power  
Recommended optical power output:  $P_o = 0.5W$
- Low operating current:  $I_{op} = 0.75A$  ( $P_o = 0.5W$ )
- Flat package with built-in photodiode, TE cooler, and thermistor

**Applications**

- Solid state laser excitation
- Medical use
- Material processes
- Measurement

**Structure**

AlGaAs quantum well structure laser diode

**Operating Lifetime**

MTTF 10,000H (effective value) at  $P_o = 0.5W$ ,  $T_{th} = 25^\circ C$

**Absolute Maximum Ratings** ( $T_{th} = 25^\circ C$ )

• Optical power output	$P_o$	0.55	W
• Reverse voltage	$V_R$	LD 2	V
		PD 15	V
• Operating temperature ( $T_{th}$ )	$T_{opr}$	-10 to +30	$^\circ C$
• Storage temperature	$T_{stg}$	-40 to +85	$^\circ C$

**Warranty**

This warranty period shall be 90 days after receipt of the product or 1,000 hours operation time whichever is shorter.

Sony Quality Assurance Department shall analyze any product that fails during said warranty period, and if the analysis results show that the product failed due to material or manufacturing defects on the part of Sony, the product shall be replaced free of charge.

Laser diodes naturally have differing lifetimes which follow a Weibull distribution.

Special warranties are also available.

**Pin Configuration (Top View)**

No.	Function
1	TE cooler (negative)
2	Thermistor lead 1
3	Thermistor lead 2
4	Laser diode (anode)
5	Laser diode (cathode)
6	Photodiode (cathode)
7	Photodiode (anode)
8	TE cooler (positive)

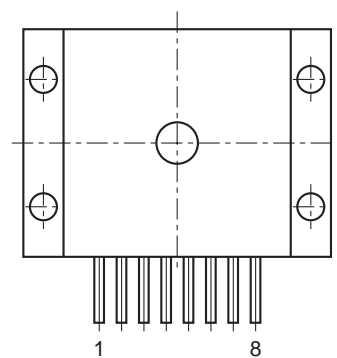

Sony reserves the right to change products and specifications without prior notice. This information does not convey any license by any implication or otherwise under any patents or other right. Application circuits shown, if any, are typical examples illustrating the operation of the devices. Sony cannot assume responsibility for any problems arising out of the use of these circuits.

**Electrical and Optical Characteristics**

(Tth: Thermistor temperature, Tth = 25°C)

Item	Symbol	Conditions	Min.	Typ.	Max.	Unit	
Threshold current	Ith			0.18	0.3	A	
Operating current	Iop	P <sub>O</sub> = 0.5W		0.75	1.2	A	
Operating voltage	Vop	P <sub>O</sub> = 0.5W		2.1	3.0	V	
Wavelength*	λp	P <sub>O</sub> = 0.5W	790		840	nm	
Monitor current	I <sub>mon</sub>	P <sub>O</sub> = 0.5W V <sub>R</sub> = 10V	0.15	0.8	3.0	mA	
Radiation angle	Perpendicular	θ <sub>⊥</sub>	P <sub>O</sub> = 0.5W	20	30	40	degree
	Parallel	θ <sub>//</sub>		4	9	17	degree
Positional accuracy	Position	ΔX, ΔY	P <sub>O</sub> = 0.5W			±100	μm
	Angle	Δφ <sub>⊥</sub>				±3	degree
Differential efficiency	η <sub>D</sub>	P <sub>O</sub> = 0.5W	0.5	0.9		W/A	
Thermistor resistance	R <sub>th</sub>	T <sub>th</sub> = 25°C		10		kΩ	

**\* Wavelength Selection Classification**

Type	Wavelength (nm)
SLD322XT-1	795 ± 5
SLD322XT-2	810 ± 10
SLD322XT-3	830 ± 10

Type	Wavelength (nm)
SLD322XT-21	798 ± 3
SLD322XT-24	807 ± 3
SLD322XT-25	810 ± 3

**Handling Precautions**

**Eye protection against laser beams**

The optical output of laser diodes ranges from several mW to 3W. However the optical power density of the laser beam at the diode chip reaches 1MW/cm<sup>2</sup>. Unlike gas lasers, since laser diode beams are divergent, uncollimated laser diode beams are fairly safe at a laser diode. For observing laser beams, ALWAYS use safety goggles that block infrared rays. Usage of IR scopes, IR cameras and fluorescent plates is also recommended for monitoring laser beams safely.

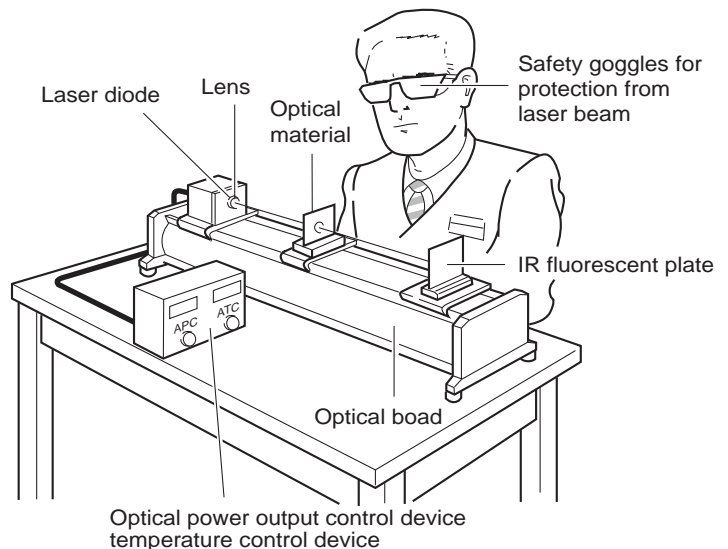

Example of Representative Characteristics

Optical power output vs. Forward current characteristics

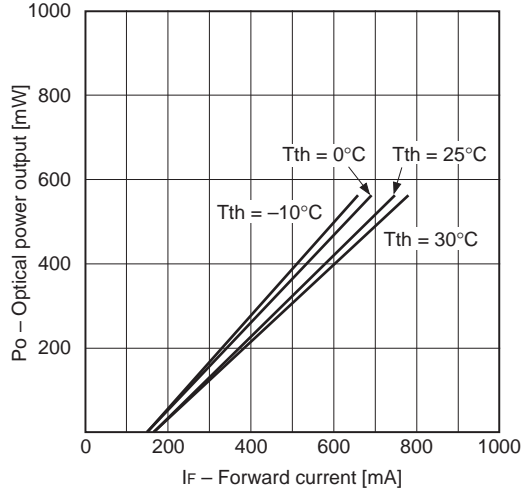

Optical power output vs. Monitor current characteristics

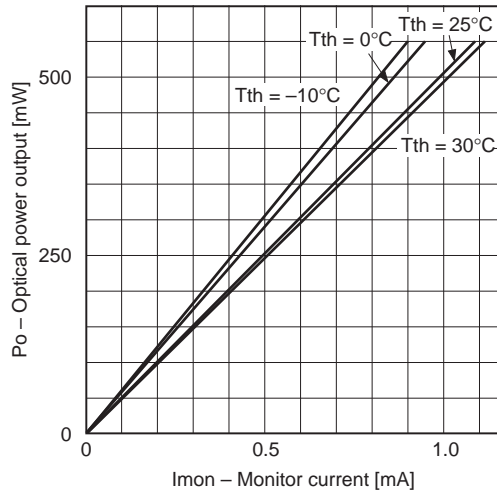

Threshold current vs. Temperature characteristics

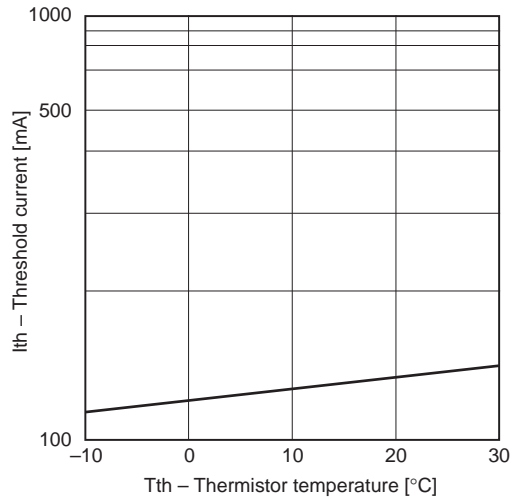

Power dependence of far field pattern (Parallel to junction)

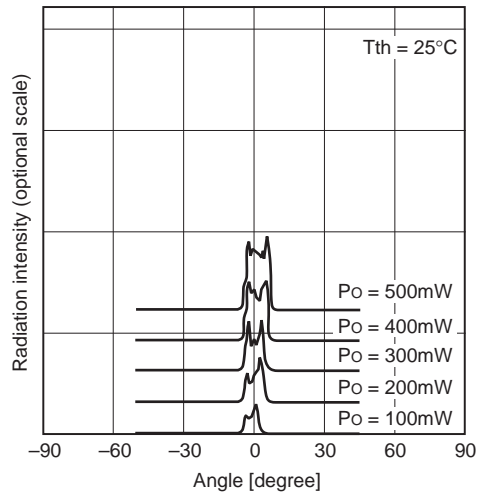

Power dependence of far field pattern (Perpendicular to junction)

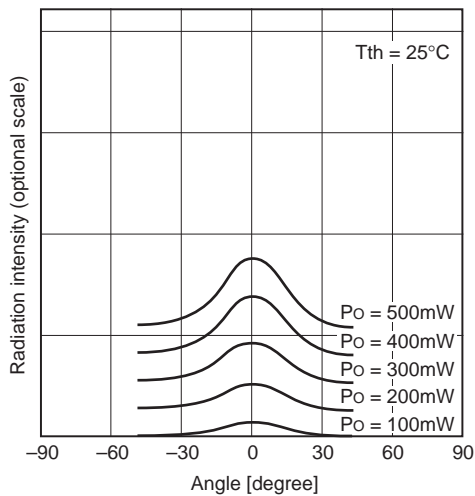

Temperature dependence of far field pattern (Parallel to junction)

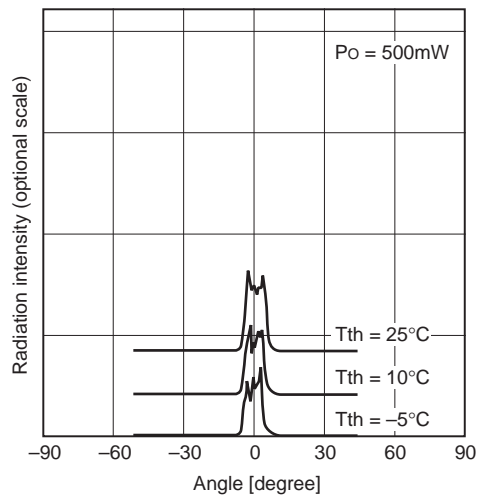

Temperature dependence of far field pattern  
(Perpendicular to junction)

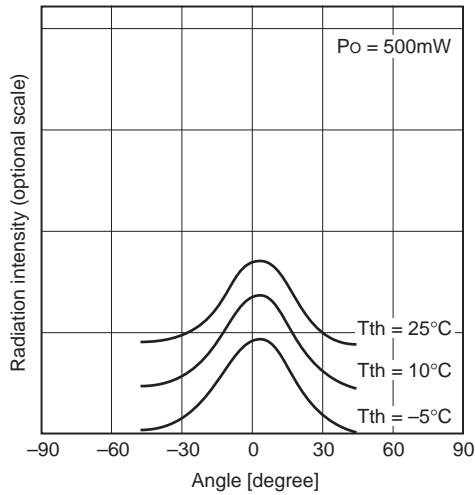

Dependence of wavelength

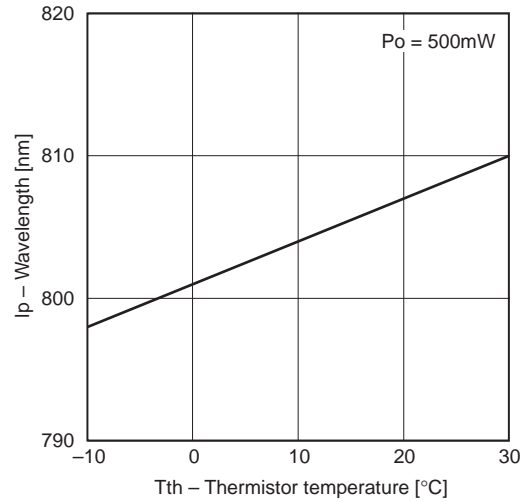

Differential efficiency vs. Temperature characteristics

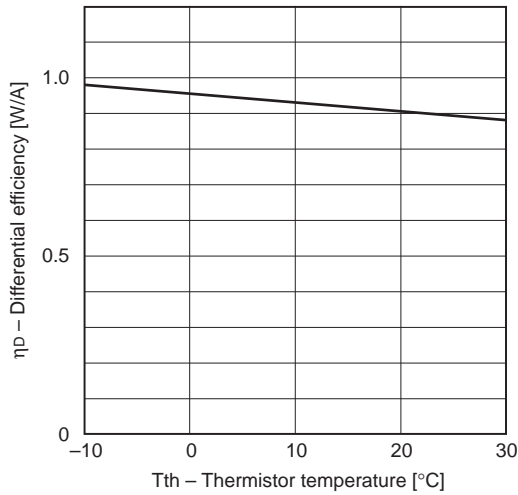

Thermistor characteristics

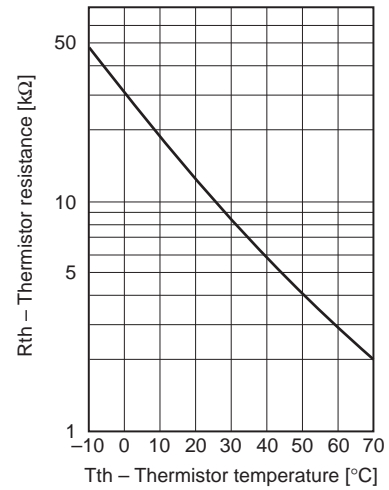

TE cooler characteristics

TE cooler characteristics 1

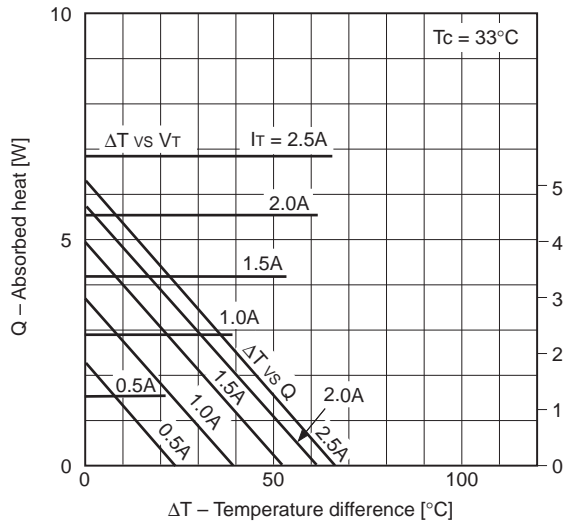

TE cooler characteristics 2

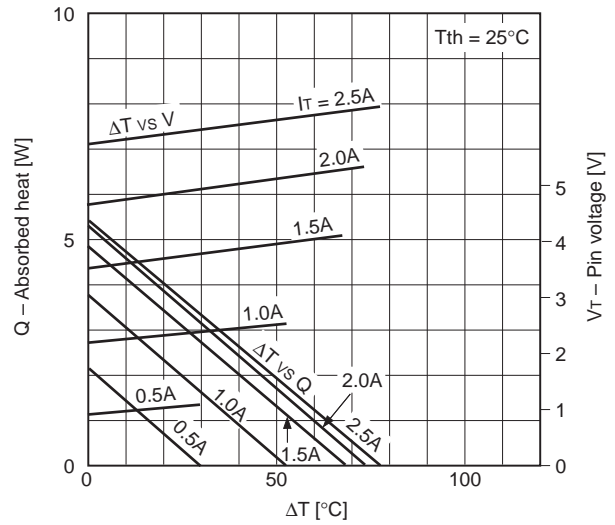

ΔT: Tc - Tth  
Tth: Thermistor temperature  
Tc: Case temperature

Power dependence of spectrum

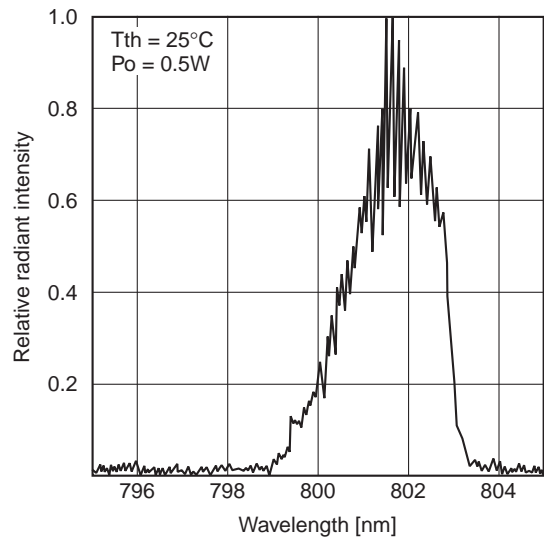
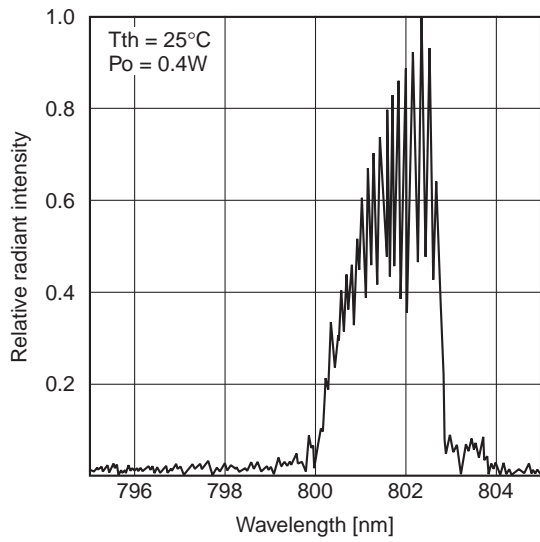
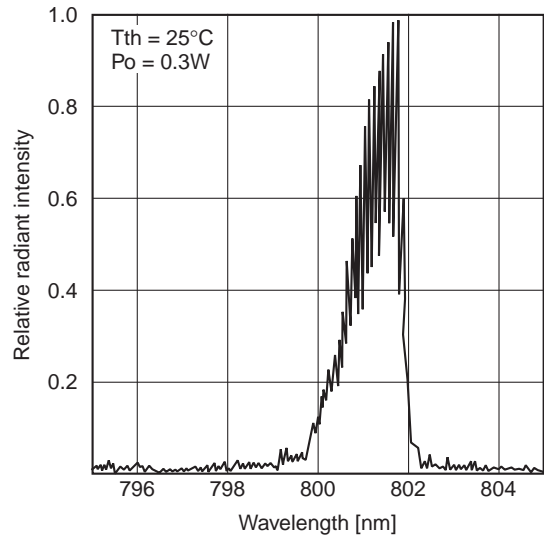
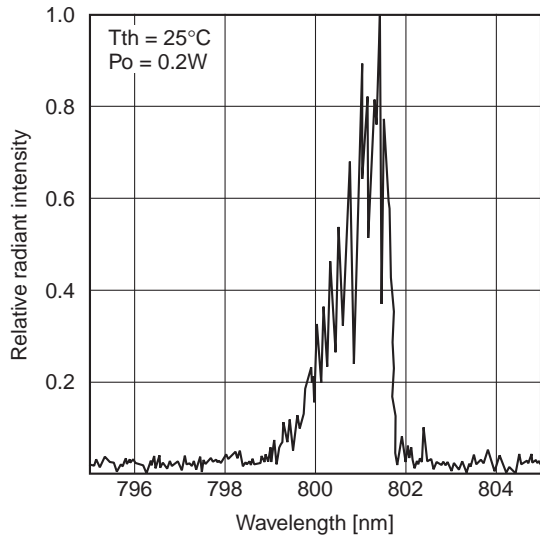

Temperature dependence of spectrum ( $P_o = 0.5W$ )

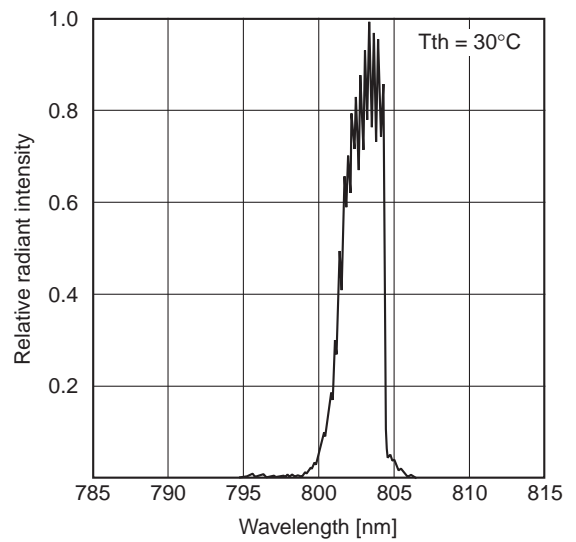
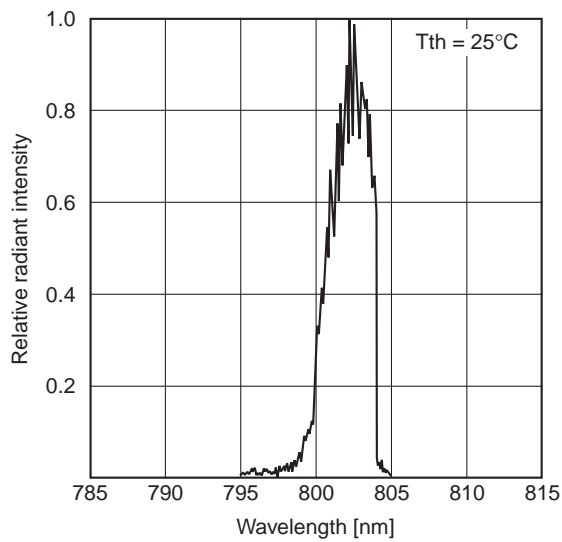
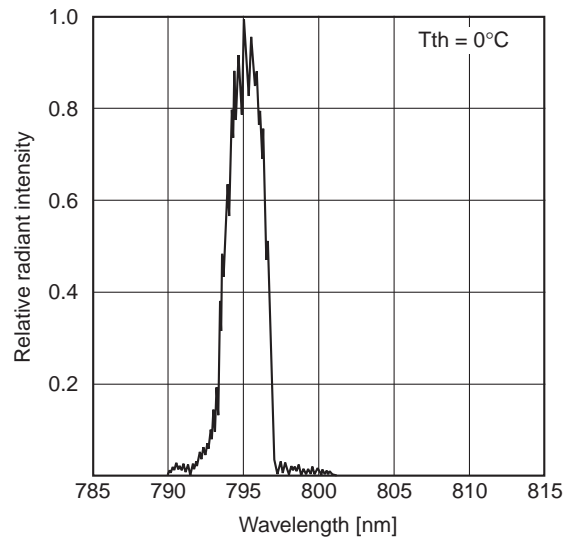
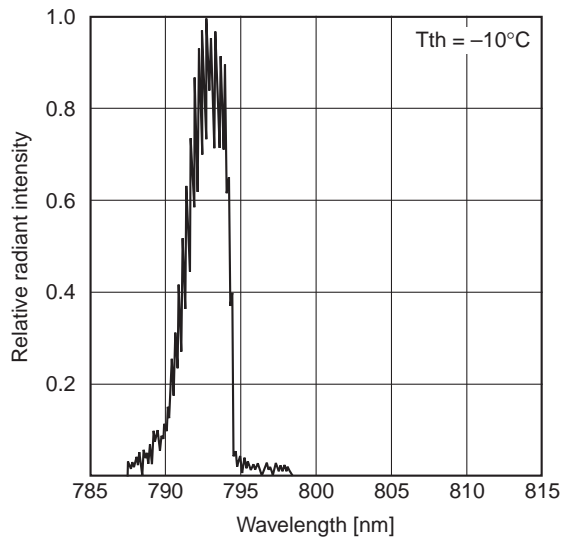

Package Outline

Unit: mm

M-273(LO-10)

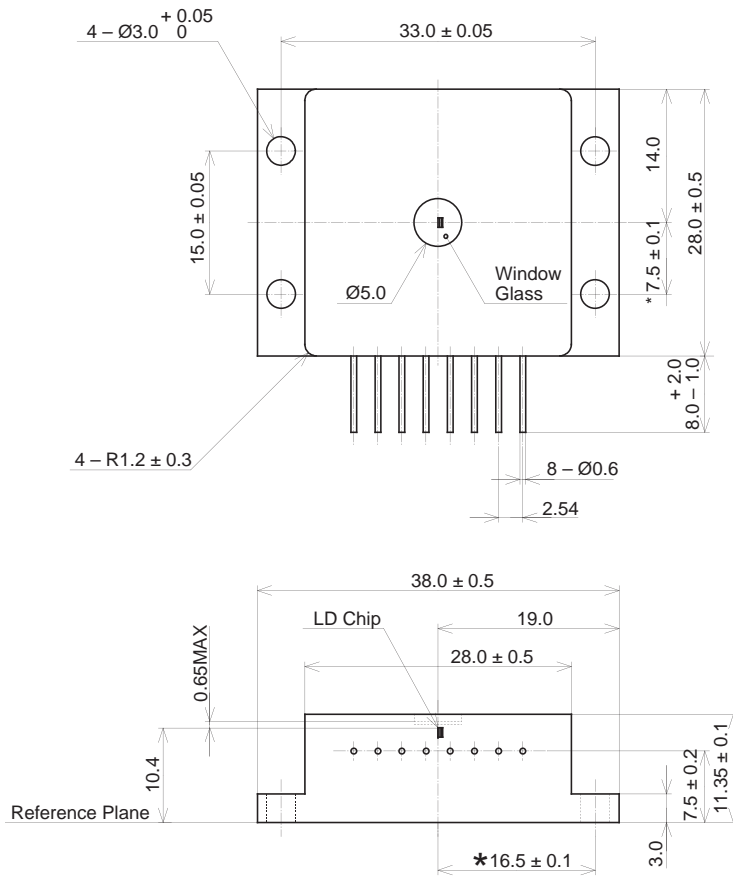

\*Distance between pilot hole and emitting area

PACKAGE STRUCTURE

SONY CODE	M-273(LO-10)
EIAJ CODE	_____
JEDEC CODE	_____

PACKAGE WEIGHT	43g
----------------	-----

This datasheet has been downloaded from:

[www.DatasheetCatalog.com](http://www.DatasheetCatalog.com)

Datasheets for electronic components.