

SHINDENGEN

Super Fast Recovery Rectifiers

Single

SF5L30

300V 5A

FEATURES

- trr30ns
- Fully Isolated Molding
- Dielectric strength 2kV guaranteed

APPLICATION

- Switching power supply
- Free Wheel
- Home Appliances, Office Equipment
- Telecommunication, Factory Automation

OUTLINE DIMENSIONS

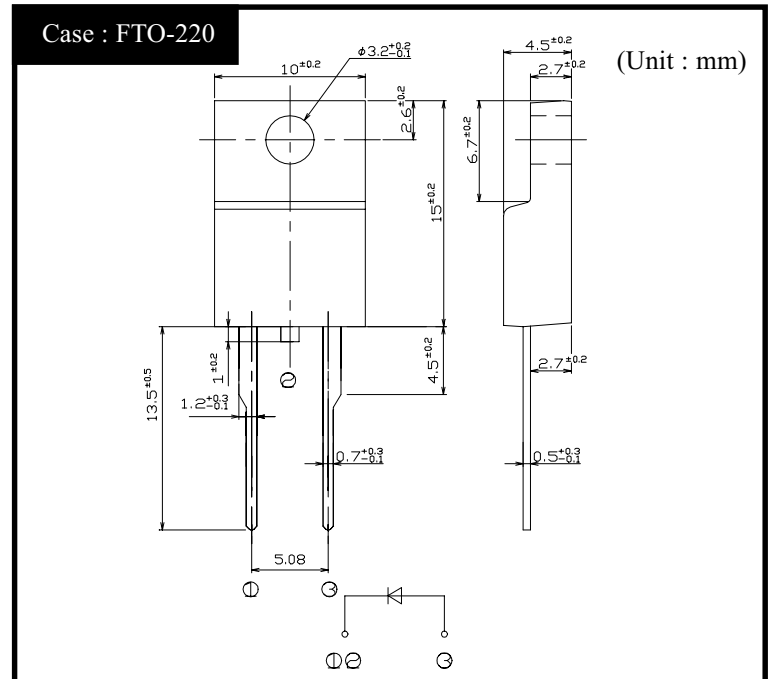

RATINGS

● Absolute Maximum Ratings (If not specified Tc=25°C)

Item	Symbol	Conditions	Ratings	Unit
Storage Temperature	T _{stg}		-55~150	°C
Operating Junction Temperature	T _j		150	°C
Maximum Reverse Voltage	V _{RM}		300	V
Average Rectified Forward Current	I _O	50Hz sine wave, R-load, Tc=130°C	5	A
Peak Surge Forward Current	I _{FSM}	50Hz sine wave, Non-repetitive 1 cycle peak value, Tj=25 °C	60	A
Dielectric Strength	V _{dis}	Terminals to case, AC 1 minute	2	kV
Mounting Torque	TOR	(Recommended torque : 0.3N·m)	0.5	N·m

● Electrical Characteristics (If not specified Tc=25°C)

Item	Symbol	Conditions	Ratings	Unit
Forward Voltage	V _F	I _F =5A, Pulse measurement	Max.1.3	V
Reverse Current	I _R	V _R =V _{RM} , Pulse measurement	Max.25	μA
Reverse Recovery Time	trr	I _F =0.5A, I _R =1A	Max.30	ns
Junction Capacitance	C _j	f=1MHz, V _R =10V	TYP 50	pF
Thermal Resistance	θ _{jc}	junction to case	Max.3.4	°C/W

SF5L30

Forward Voltage

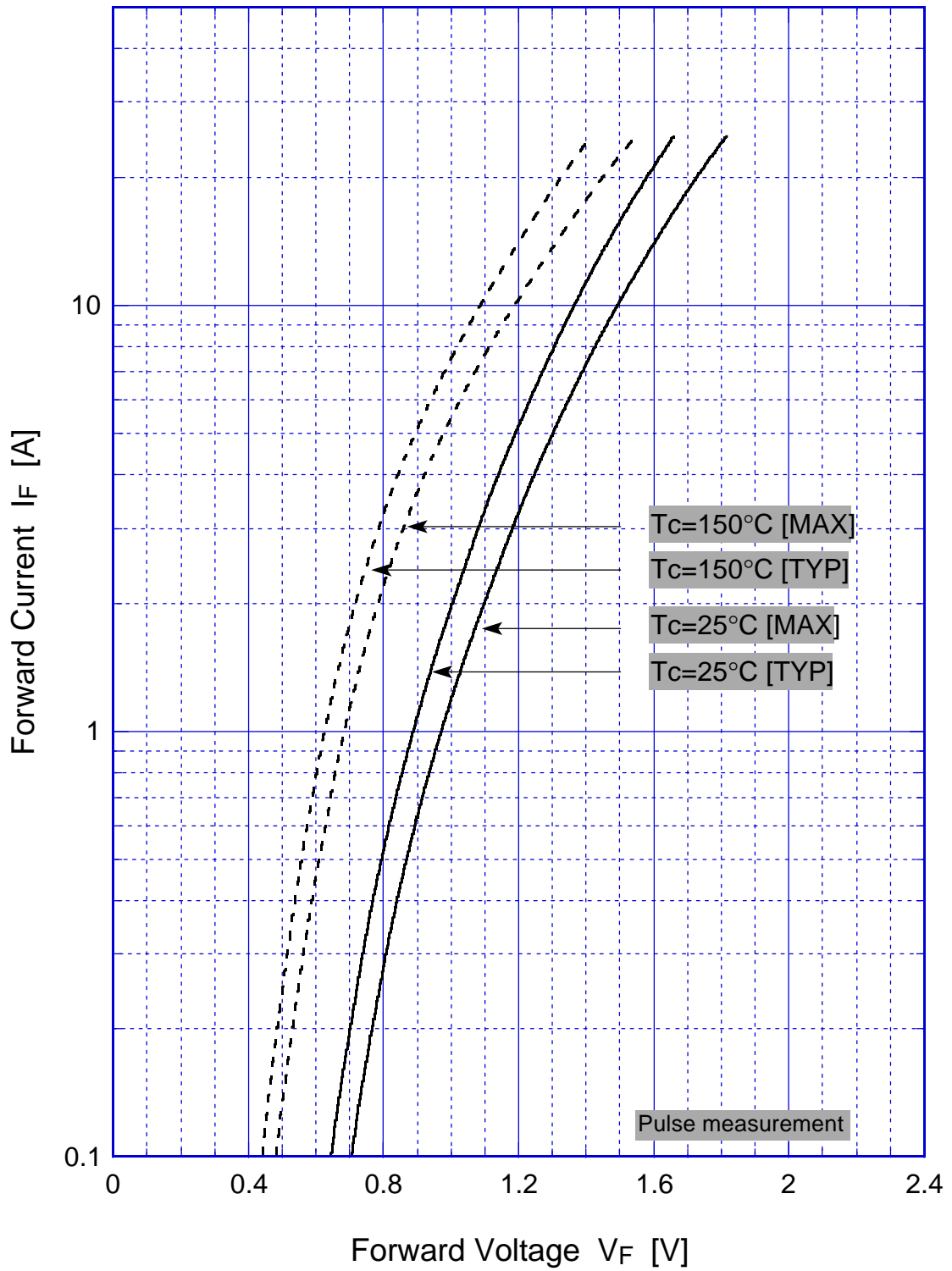

SF5L30

Forward Power Dissipation

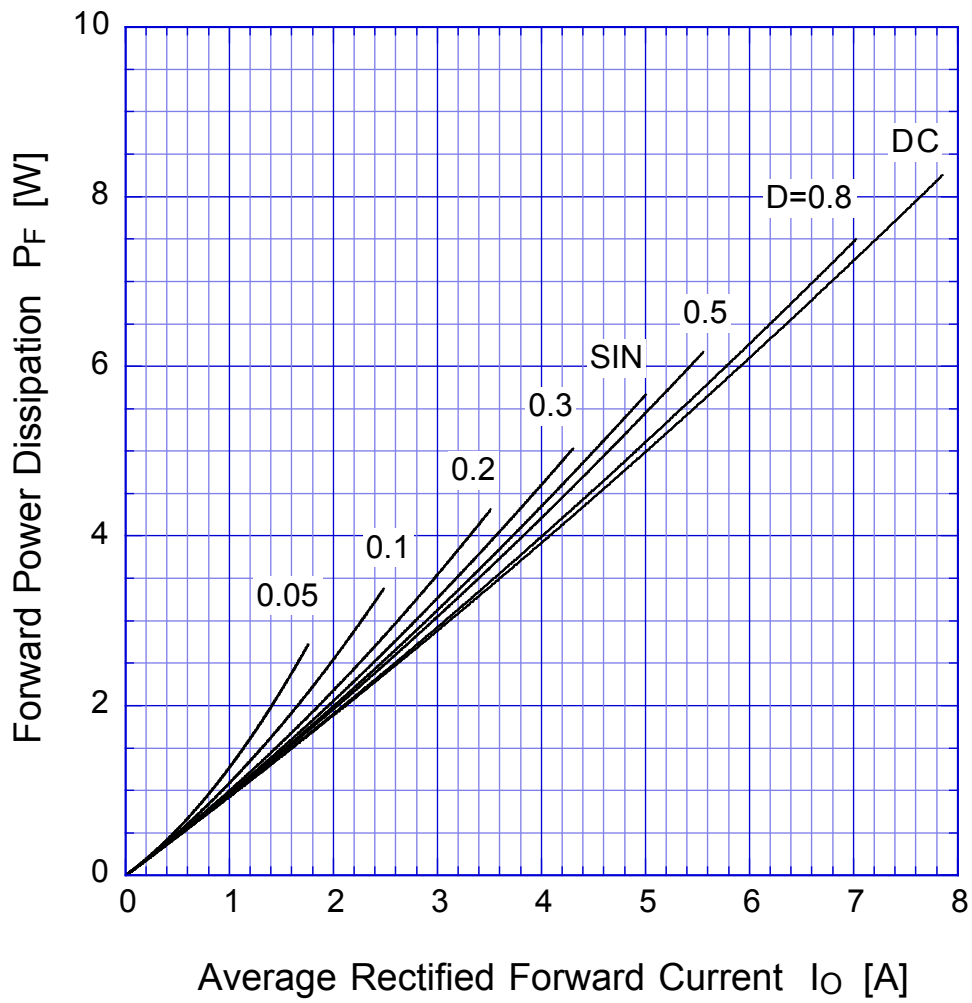

$T_j = 150^\circ\text{C}$

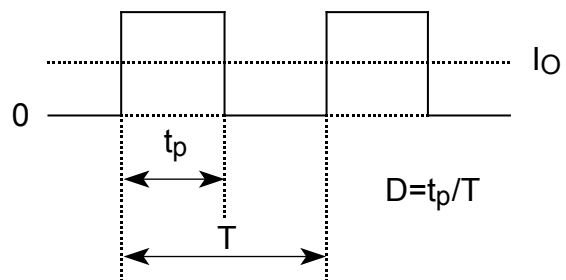

SF5L30

Peak Surge Forward Capability

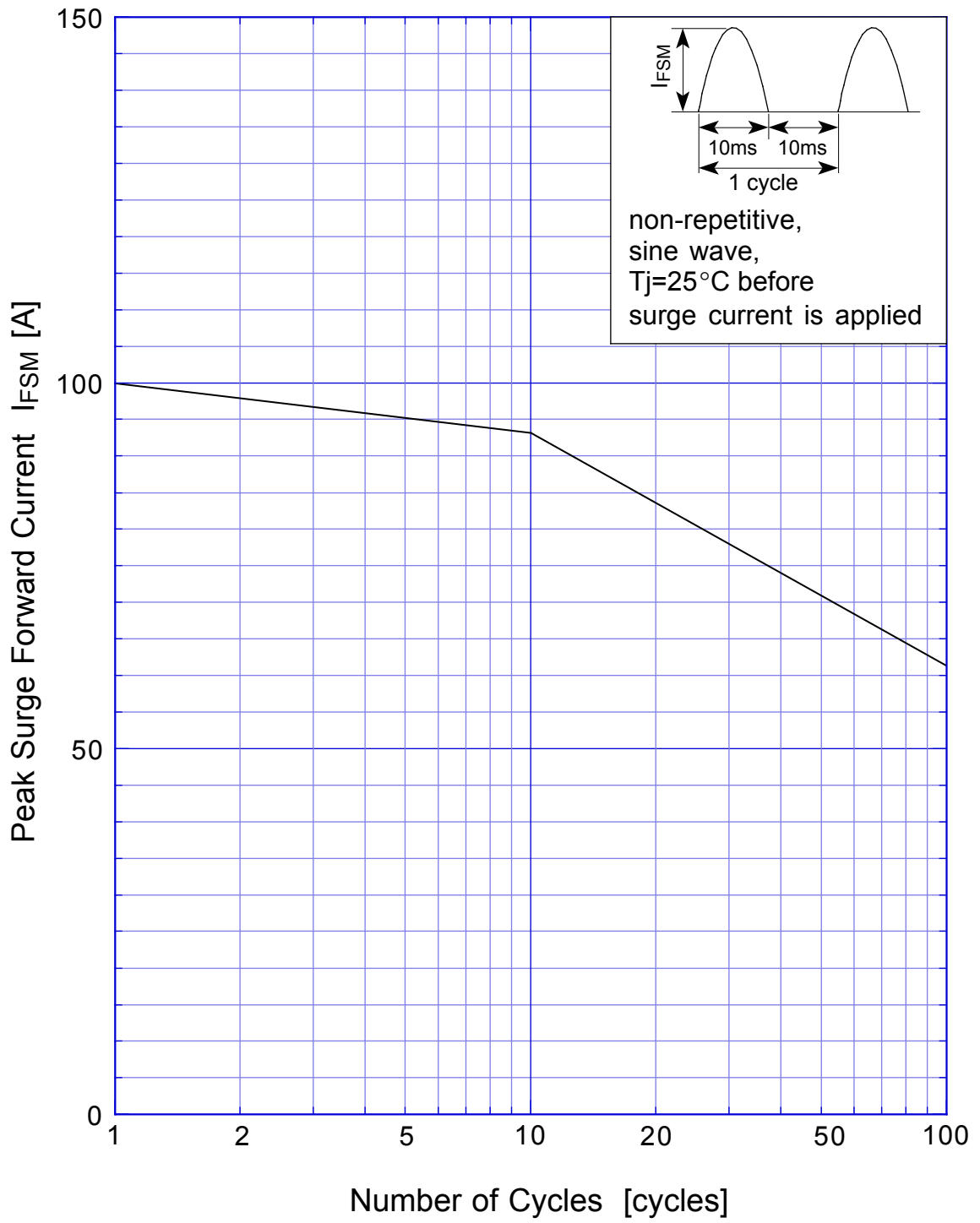

SF5L30

Derating Curve

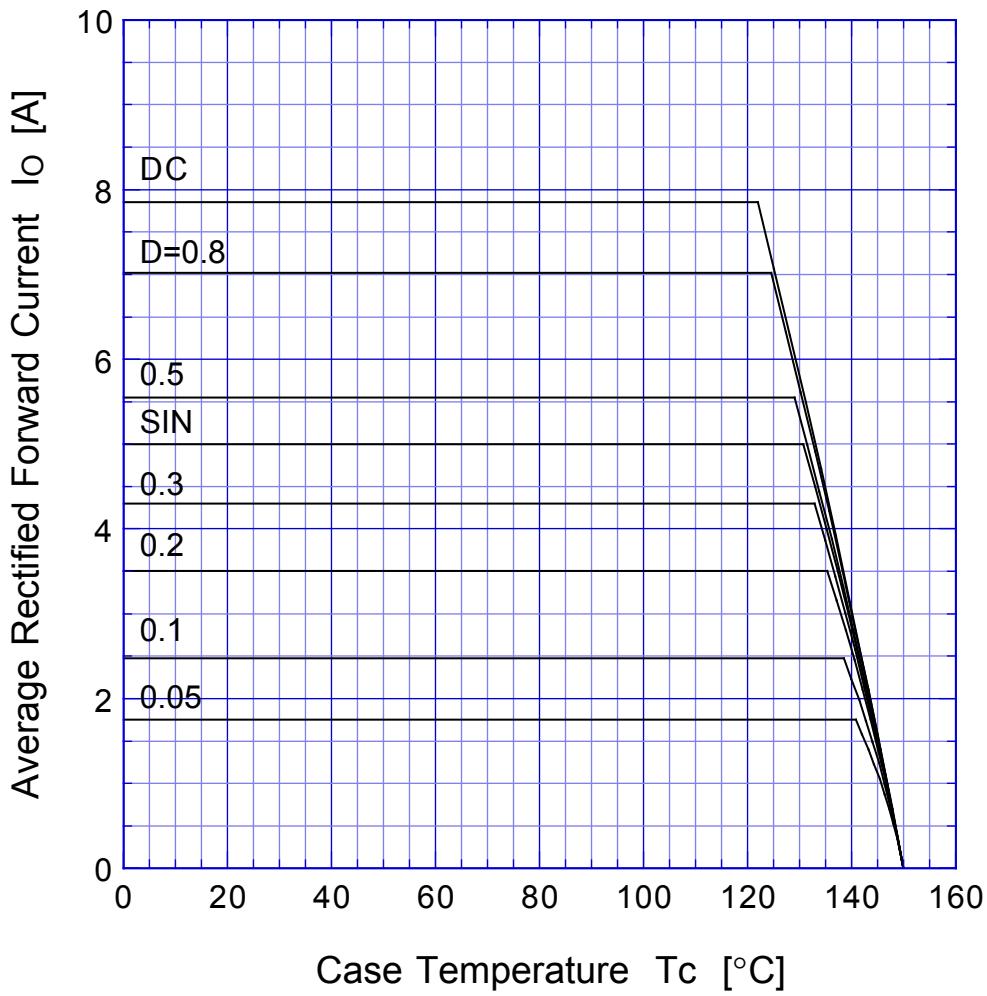

$$V_R = V_{RM}$$

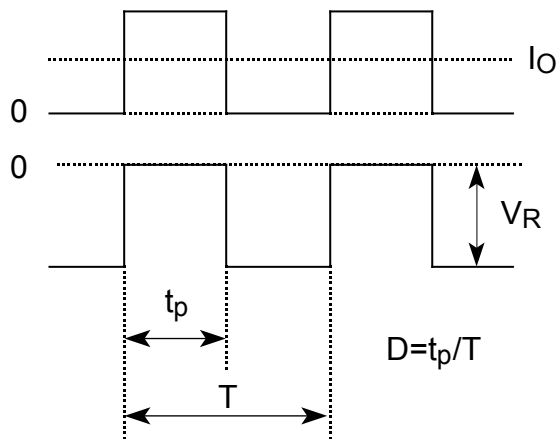

SF5L30 Junction Capacitance

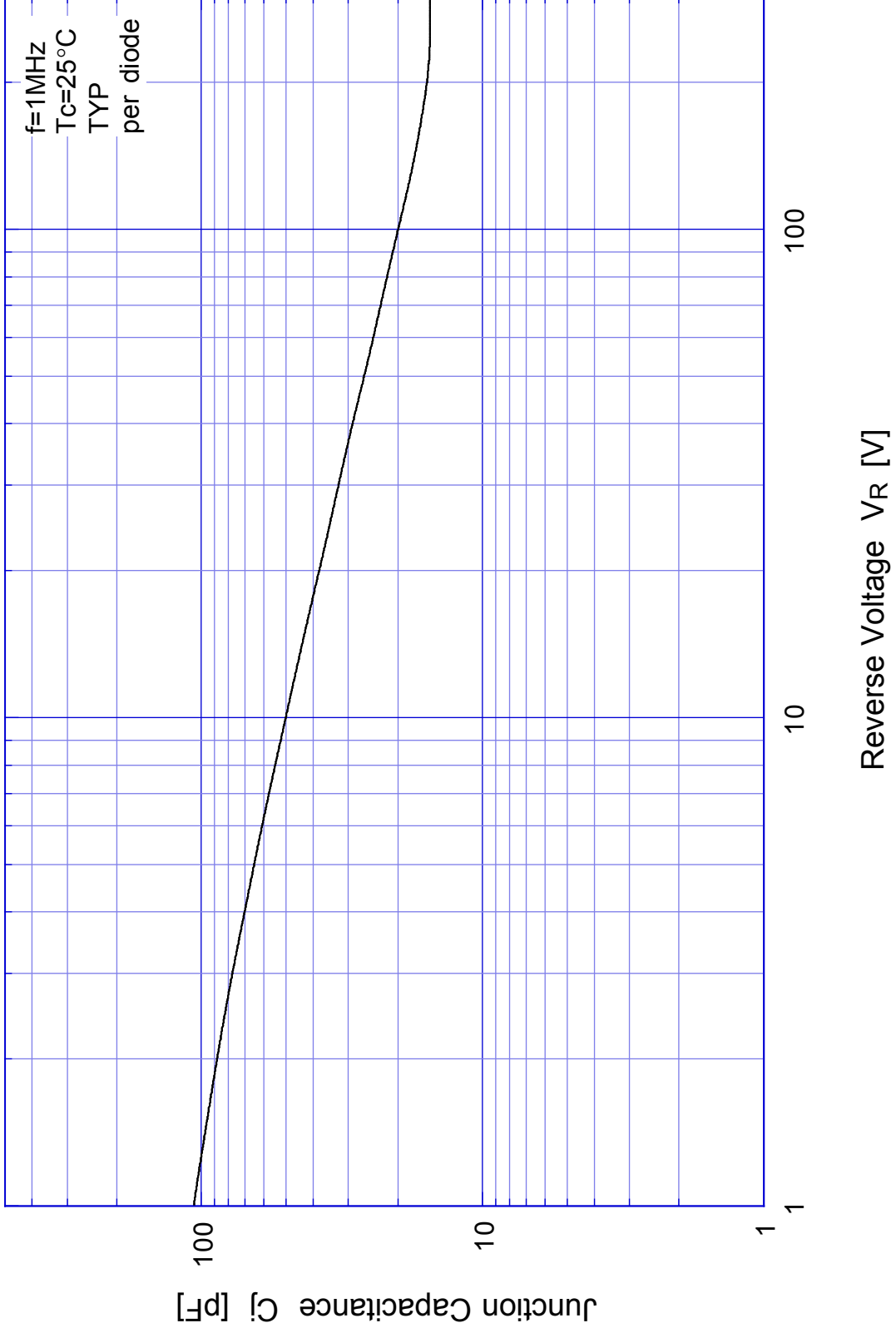

This datasheet has been download from:

www.datasheetcatalog.com

Datasheets for electronics components.