

# 74ACT11244 OCTAL BUFFER/LINE DRIVER WITH 3-STATE OUTPUTS

SCAS006C – AUGUST 1987 – REVISED APRIL 1996

- 3-State Outputs Drive Bus Lines or Buffer Memory Address Registers
- Inputs Are TTL-Voltage Compatible
- Flow-Through Architecture Optimizes PCB Layout
- Center-Pin  $V_{CC}$  and GND Configurations to Minimize High-Speed Switching Noise
- EPIC™ (Enhanced-Performance Implanted CMOS) 1- $\mu$ m Process
- 500-mA Typical Latch-Up Immunity at 125°C
- Package Options Include Plastic Small-Outline (DW), Shrink Small-Outline (DB), and Thin Shrink Small-Outline (PW) Packages, and Standard Plastic 300-mil DIPs (NT)

DB, DW, NT, OR PW PACKAGE  
(TOP VIEW)

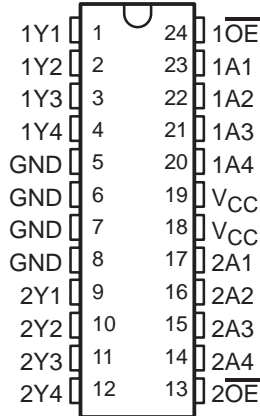

## description

This octal buffer or line driver is designed specifically to improve both the performance and density of 3-state memory address drivers, clock drivers, and bus-oriented receivers and transmitters. Together with the 'ACT11240, this device provides the choice of various combinations of inverting and noninverting outputs.

The 74ACT11244 is characterized for operation from  $-40^{\circ}\text{C}$  to  $85^{\circ}\text{C}$ .

FUNCTION TABLE

OUTPUT ENABLE	DATA INPUT	OUTPUT
$\overline{1OE}, \overline{2OE}$	A	Y
H	X	Z
L	L	L
L	H	H

## logic symbol†

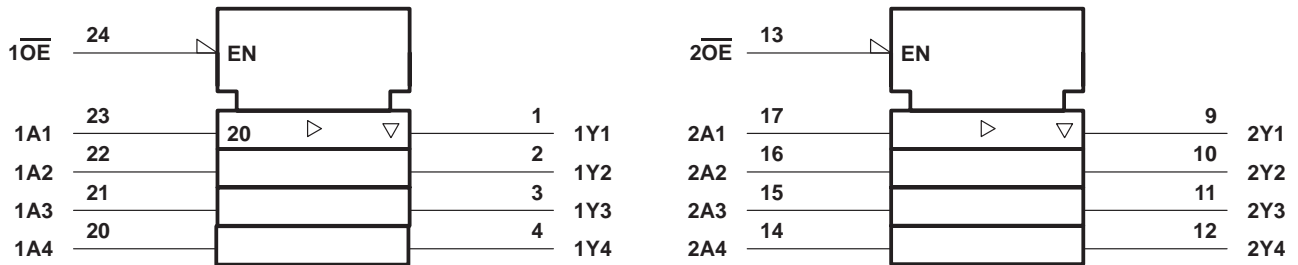

† This symbol is in accordance with ANSI/IEEE Std 91-1984 and IEC Publication 617-12.



Please be aware that an important notice concerning availability, standard warranty, and use in critical applications of Texas Instruments semiconductor products and disclaimers thereto appears at the end of this data sheet.

EPIC is a trademark of Texas Instruments Incorporated.

PRODUCTION DATA information is current as of publication date. Products conform to specifications per the terms of Texas Instruments standard warranty. Production processing does not necessarily include testing of all parameters.

**TEXAS  
INSTRUMENTS**

POST OFFICE BOX 655303 • DALLAS, TEXAS 75265

Copyright © 1996, Texas Instruments Incorporated

**74ACT11244**  
**OCTAL BUFFER/LINE DRIVER**  
**WITH 3-STATE OUTPUTS**  
 SCAS006C – AUGUST 1987 – REVISED APRIL 1996

**logic diagram (positive logic)**

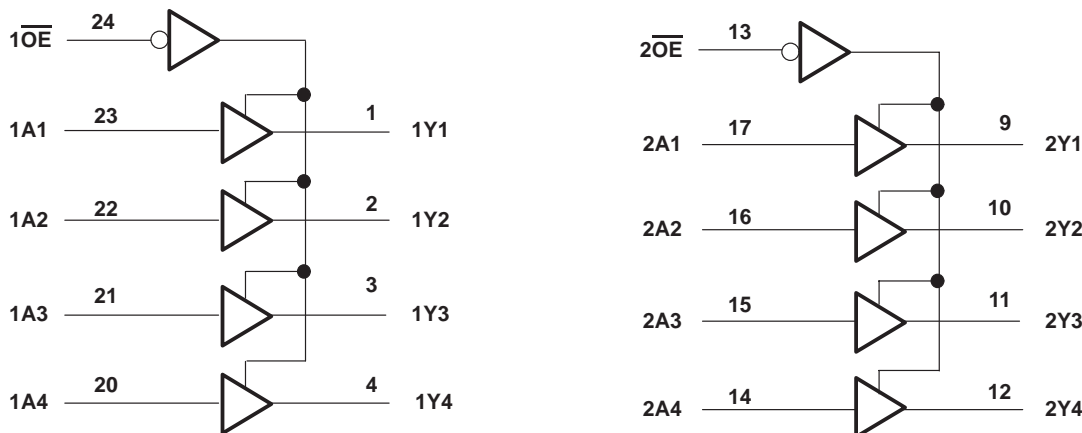

**absolute maximum ratings over operating free-air temperature range (unless otherwise noted)†**

Supply voltage range, $V_{CC}$ .....	-0.5 V to 6 V
Input voltage range, $V_I$ (see Note 1) .....	-0.5 V to $V_{CC} + 0.5$ V
Output voltage range, $V_O$ (see Note 1) .....	-0.5 V to $V_{CC} + 0.5$ V
Input clamp current, $I_{IK}$ ( $V_I < 0$ or $V_I > V_{CC}$ ) .....	$\pm 20$ mA
Output clamp current, $I_{OK}$ ( $V_O < 0$ or $V_O > V_{CC}$ ) .....	$\pm 50$ mA
Continuous output current, $I_O$ ( $V_O = 0$ to $V_{CC}$ ) .....	$\pm 50$ mA
Continuous current through $V_{CC}$ or GND .....	$\pm 200$ mA
Maximum power dissipation at $T_A = 55^\circ\text{C}$ (in still air) (see Note 2):	
DB package .....	0.65 W
DW package .....	1.7 W
NT package .....	1.3 W
PW package .....	0.7 W
Storage temperature range, $T_{stg}$ .....	$-65^\circ\text{C}$ to $150^\circ\text{C}$

† Stresses beyond those listed under “absolute maximum ratings” may cause permanent damage to the device. These are stress ratings only, and functional operation of the device at these or any other conditions beyond those indicated under “recommended operating conditions” is not implied. Exposure to absolute-maximum-rated conditions for extended periods may affect device reliability.

- NOTES: 1. The input and output voltage ratings may be exceeded if the input and output current ratings are observed.  
 2. The maximum package power dissipation is calculated using a junction temperature of  $150^\circ\text{C}$  and a board trace length of 750 mils, except for the NT package, which has a trace length of zero.

**recommended operating conditions**

		MIN	MAX	UNIT
$V_{CC}$	Supply voltage	4.5	5.5	V
$V_{IH}$	High-level input voltage	2		V
$V_{IL}$	Low-level input voltage		0.8	V
$V_I$	Input voltage	0	$V_{CC}$	V
$V_O$	Output voltage	0	$V_{CC}$	V
$I_{OH}$	High-level output current		-24	mA
$I_{OL}$	Low-level output current		24	mA
$\Delta t/\Delta v$	Input transition rise or fall rate	0	10	ns/V
$T_A$	Operating free-air temperature	-40	85	$^\circ\text{C}$



electrical characteristics over recommended operating free-air temperature range (unless otherwise noted)

PARAMETER	TEST CONDITIONS	V <sub>CC</sub>	T <sub>A</sub> = 25°C			MIN	MAX	UNIT
			MIN	TYP	MAX			
V <sub>OH</sub>	I <sub>OH</sub> = -50 μA	4.5 V	4.4			4.4		V
		5.5 V	5.4			5.4		
	I <sub>OH</sub> = -24 mA	4.5 V	3.94			3.8		
		5.5 V	4.94			4.8		
	I <sub>OH</sub> = -75 mA†	5.5 V				3.85		
	V <sub>OL</sub>	I <sub>OL</sub> = 50 μA	4.5 V				0.1	
5.5 V						0.1		
I <sub>OL</sub> = 24 mA		4.5 V				0.36		
		5.5 V				0.36		
I <sub>OL</sub> = 75 mA†		5.5 V				1.65		
I <sub>OZ</sub>		V <sub>O</sub> = V <sub>CC</sub> or GND	5.5 V				±0.5	
I <sub>I</sub>	V <sub>I</sub> = V <sub>CC</sub> or GND	5.5 V				±0.1		μA
I <sub>CC</sub>	V <sub>I</sub> = V <sub>CC</sub> or GND, I <sub>O</sub> = 0	5.5 V				8		μA
ΔI <sub>CC</sub> ‡	One input at 3.4 V, Other inputs at GND or V <sub>CC</sub>	5.5 V				0.9		mA
C <sub>i</sub>	V <sub>I</sub> = V <sub>CC</sub> or GND	5 V				4		pF
C <sub>o</sub>	V <sub>O</sub> = V <sub>CC</sub> or GND	5 V				10		pF

† Not more than one output should be tested at a time, and the duration of the test should not exceed 10 ms.

‡ This is the increase in supply current for each input that is at one of the specified TTL voltage levels rather than 0 V or V<sub>CC</sub>.

switching characteristics over recommended operating free-air temperature range, V<sub>CC</sub> = 5 V ± 0.5 V (unless otherwise noted) (see Figure 1)

PARAMETER	FROM (INPUT)	TO (OUTPUT)	T <sub>A</sub> = 25°C			MIN	MAX	UNIT
			MIN	TYP	MAX			
t <sub>PLH</sub>	A	Y	1.5	6	8.9	1.5	9.9	ns
t <sub>PHL</sub>			1.5	5.4	8.6	1.5	9.2	
t <sub>PZH</sub>	$\overline{OE}$	Y	1.5	6.6	11.3	1.5	12.5	ns
t <sub>PZL</sub>			1.5	6.7	10.5	1.5	11.4	
t <sub>PHZ</sub>	$\overline{OE}$	Y	1.5	7.4	9.8	1.5	10.4	ns
t <sub>PLZ</sub>			1.5	7.8	10.6	1.5	11.2	

operating characteristics, V<sub>CC</sub> = 5 V, T<sub>A</sub> = 25°C

PARAMETER		TEST CONDITIONS	TYP	UNIT
C <sub>pd</sub>	Power dissipation capacitance per buffer	Outputs enabled	27	pF
		Outputs disabled	9	

PARAMETER MEASUREMENT INFORMATION

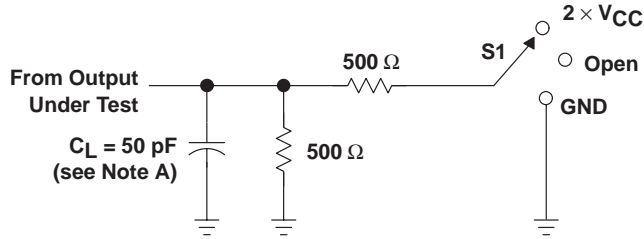

LOAD CIRCUIT

TEST	S1
$t_{PLH}/t_{PHL}$	Open
$t_{PLZ}/t_{PZL}$	$2 \times V_{CC}$
$t_{PHZ}/t_{PZH}$	GND

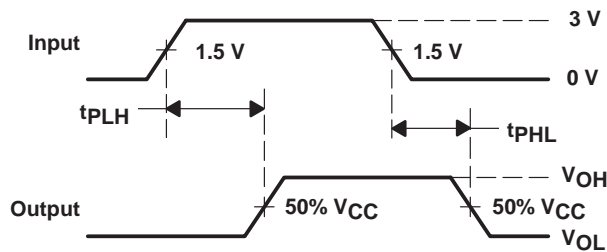

VOLTAGE WAVEFORMS

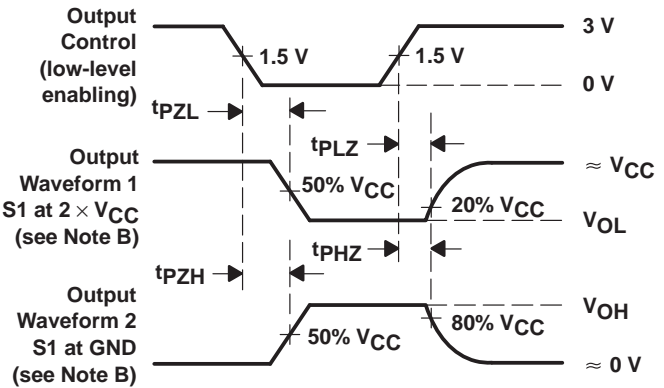

VOLTAGE WAVEFORMS

- NOTES: A.  $C_L$  includes probe and jig capacitance.  
 B. Waveform 1 is for an output with internal conditions such that the output is low except when disabled by the output control. Waveform 2 is for an output with internal conditions such that the output is high except when disabled by the output control.  
 C. All input pulses are supplied by generators having the following characteristics:  $PRR \leq 1 \text{ MHz}$ ,  $Z_O = 50 \Omega$ ,  $t_r = 3 \text{ ns}$ ,  $t_f = 3 \text{ ns}$ .  
 D. The outputs are measured one at a time with one input transition per measurement.

Figure 1. Load Circuit and Voltage Waveforms

**PACKAGING INFORMATION**

Orderable Device	Status <sup>(1)</sup>	Package Type	Package Drawing	Pins	Package Qty	Eco Plan <sup>(2)</sup>	Lead/Ball Finish	MSL Peak Temp <sup>(3)</sup>
74ACT11244DBLE	OBSOLETE	SSOP	DB	24		None	Call TI	Call TI
74ACT11244DBR	ACTIVE	SSOP	DB	24	2000	Pb-Free (RoHS)	CU NIPDAU	Level-2-260C-1 YEAR/ Level-1-235C-UNLIM
74ACT11244DW	ACTIVE	SOIC	DW	24	25	Pb-Free (RoHS)	CU NIPDAU	Level-2-250C-1 YEAR/ Level-1-235C-UNLIM
74ACT11244DWR	ACTIVE	SOIC	DW	24	2000	Pb-Free (RoHS)	CU NIPDAU	Level-2-250C-1 YEAR/ Level-1-235C-UNLIM
74ACT11244NSR	ACTIVE	SO	NS	24	2000	Pb-Free (RoHS)	CU NIPDAU	Level-2-260C-1 YEAR/ Level-1-235C-UNLIM
74ACT11244NT	ACTIVE	PDIP	NT	24	15	Pb-Free (RoHS)	CU NIPDAU	Level-NC-NC-NC
74ACT11244PW	ACTIVE	TSSOP	PW	24	60	Pb-Free (RoHS)	CU NIPDAU	Level-1-250C-UNLIM
74ACT11244PWLE	OBSOLETE	TSSOP	PW	24		None	Call TI	Call TI
74ACT11244PWR	ACTIVE	TSSOP	PW	24	2000	Pb-Free (RoHS)	CU NIPDAU	Level-1-250C-UNLIM

<sup>(1)</sup> The marketing status values are defined as follows:

**ACTIVE:** Product device recommended for new designs.

**LIFEBUY:** TI has announced that the device will be discontinued, and a lifetime-buy period is in effect.

**NRND:** Not recommended for new designs. Device is in production to support existing customers, but TI does not recommend using this part in a new design.

**PREVIEW:** Device has been announced but is not in production. Samples may or may not be available.

**OBSOLETE:** TI has discontinued the production of the device.

<sup>(2)</sup> Eco Plan - May not be currently available - please check <http://www.ti.com/productcontent> for the latest availability information and additional product content details.

**None:** Not yet available Lead (Pb-Free).

**Pb-Free (RoHS):** TI's terms "Lead-Free" or "Pb-Free" mean semiconductor products that are compatible with the current RoHS requirements for all 6 substances, including the requirement that lead not exceed 0.1% by weight in homogeneous materials. Where designed to be soldered at high temperatures, TI Pb-Free products are suitable for use in specified lead-free processes.

**Green (RoHS & no Sb/Br):** TI defines "Green" to mean "Pb-Free" and in addition, uses package materials that do not contain halogens, including bromine (Br) or antimony (Sb) above 0.1% of total product weight.

<sup>(3)</sup> MSL, Peak Temp. -- The Moisture Sensitivity Level rating according to the JEDEC industry standard classifications, and peak solder temperature.

**Important Information and Disclaimer:** The information provided on this page represents TI's knowledge and belief as of the date that it is provided. TI bases its knowledge and belief on information provided by third parties, and makes no representation or warranty as to the accuracy of such information. Efforts are underway to better integrate information from third parties. TI has taken and continues to take reasonable steps to provide representative and accurate information but may not have conducted destructive testing or chemical analysis on incoming materials and chemicals. TI and TI suppliers consider certain information to be proprietary, and thus CAS numbers and other limited information may not be available for release.

In no event shall TI's liability arising out of such information exceed the total purchase price of the TI part(s) at issue in this document sold by TI to Customer on an annual basis.

NT (R-PDIP-T\*\*)

PLASTIC DUAL-IN-LINE PACKAGE

24 PINS SHOWN

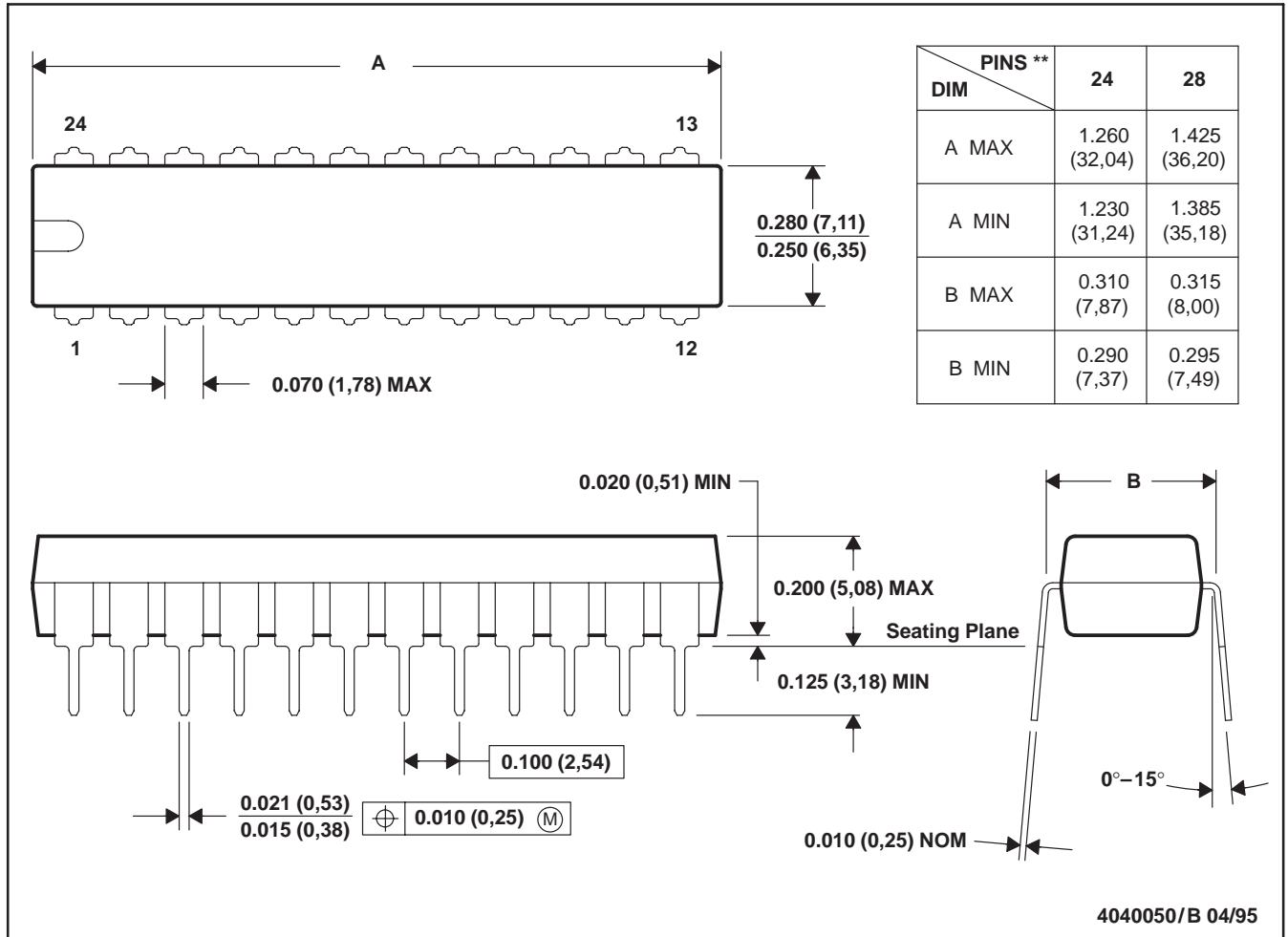

- NOTES: A. All linear dimensions are in inches (millimeters).  
 B. This drawing is subject to change without notice.



# MECHANICAL DATA

NS (R-PDSO-G\*\*)

PLASTIC SMALL-OUTLINE PACKAGE

14-PINS SHOWN



- NOTES:
- A. All linear dimensions are in millimeters.
  - B. This drawing is subject to change without notice.
  - C. Body dimensions do not include mold flash or protrusion, not to exceed 0,15.



DB (R-PDSO-G\*\*)

PLASTIC SMALL-OUTLINE

28 PINS SHOWN



- NOTES: A. All linear dimensions are in millimeters.  
 B. This drawing is subject to change without notice.  
 C. Body dimensions do not include mold flash or protrusion not to exceed 0,15.  
 D. Falls within JEDEC MO-150

PW (R-PDSO-G\*\*)

PLASTIC SMALL-OUTLINE PACKAGE

14 PINS SHOWN



4040064/F 01/97

- NOTES: A. All linear dimensions are in millimeters.  
 B. This drawing is subject to change without notice.  
 C. Body dimensions do not include mold flash or protrusion not to exceed 0,15.  
 D. Falls within JEDEC MO-153

## IMPORTANT NOTICE

Texas Instruments Incorporated and its subsidiaries (TI) reserve the right to make corrections, modifications, enhancements, improvements, and other changes to its products and services at any time and to discontinue any product or service without notice. Customers should obtain the latest relevant information before placing orders and should verify that such information is current and complete. All products are sold subject to TI's terms and conditions of sale supplied at the time of order acknowledgment.

TI warrants performance of its hardware products to the specifications applicable at the time of sale in accordance with TI's standard warranty. Testing and other quality control techniques are used to the extent TI deems necessary to support this warranty. Except where mandated by government requirements, testing of all parameters of each product is not necessarily performed.

TI assumes no liability for applications assistance or customer product design. Customers are responsible for their products and applications using TI components. To minimize the risks associated with customer products and applications, customers should provide adequate design and operating safeguards.

TI does not warrant or represent that any license, either express or implied, is granted under any TI patent right, copyright, mask work right, or other TI intellectual property right relating to any combination, machine, or process in which TI products or services are used. Information published by TI regarding third-party products or services does not constitute a license from TI to use such products or services or a warranty or endorsement thereof. Use of such information may require a license from a third party under the patents or other intellectual property of the third party, or a license from TI under the patents or other intellectual property of TI.

Reproduction of information in TI data books or data sheets is permissible only if reproduction is without alteration and is accompanied by all associated warranties, conditions, limitations, and notices. Reproduction of this information with alteration is an unfair and deceptive business practice. TI is not responsible or liable for such altered documentation.

Resale of TI products or services with statements different from or beyond the parameters stated by TI for that product or service voids all express and any implied warranties for the associated TI product or service and is an unfair and deceptive business practice. TI is not responsible or liable for any such statements.

Following are URLs where you can obtain information on other Texas Instruments products and application solutions:

<b>Products</b>		<b>Applications</b>	
Amplifiers	<a href="http://amplifier.ti.com">amplifier.ti.com</a>	Audio	<a href="http://www.ti.com/audio">www.ti.com/audio</a>
Data Converters	<a href="http://dataconverter.ti.com">dataconverter.ti.com</a>	Automotive	<a href="http://www.ti.com/automotive">www.ti.com/automotive</a>
DSP	<a href="http://dsp.ti.com">dsp.ti.com</a>	Broadband	<a href="http://www.ti.com/broadband">www.ti.com/broadband</a>
Interface	<a href="http://interface.ti.com">interface.ti.com</a>	Digital Control	<a href="http://www.ti.com/digitalcontrol">www.ti.com/digitalcontrol</a>
Logic	<a href="http://logic.ti.com">logic.ti.com</a>	Military	<a href="http://www.ti.com/military">www.ti.com/military</a>
Power Mgmt	<a href="http://power.ti.com">power.ti.com</a>	Optical Networking	<a href="http://www.ti.com/opticalnetwork">www.ti.com/opticalnetwork</a>
Microcontrollers	<a href="http://microcontroller.ti.com">microcontroller.ti.com</a>	Security	<a href="http://www.ti.com/security">www.ti.com/security</a>
		Telephony	<a href="http://www.ti.com/telephony">www.ti.com/telephony</a>
		Video & Imaging	<a href="http://www.ti.com/video">www.ti.com/video</a>
		Wireless	<a href="http://www.ti.com/wireless">www.ti.com/wireless</a>

Mailing Address: Texas Instruments  
Post Office Box 655303 Dallas, Texas 75265

This datasheet has been download from:

[www.datasheetcatalog.com](http://www.datasheetcatalog.com)

Datasheets for electronics components.