

Typical Applications

- CDMA PCS/Cellular Handsets
- TDMA PCS/Cellular Handsets
- W-CDMA Handsets

Product Description

The RF2381 is a linear variable gain amplifier suitable for use in TDMA and CDMA systems in the cellular or PCS band and for W-CDMA systems. The features of this device include linear gain control, high gain, and high linearity. The IC is manufactured on an advanced Gallium Arsenide Heterojunction Bipolar Transistor (GaAs HBT) process and is featured in an industry-standard miniature 6-lead plastic SOT package.

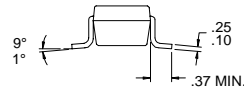
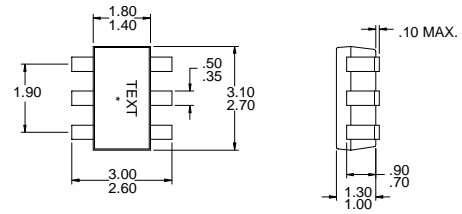

*When Pin 1 is in upper left, text reads downward (as shown).

All dimensions in mm.

Optimum Technology Matching® Applied

- Si BJT GaAs HBT GaAs MESFET
 Si Bi-CMOS SiGe HBT Si CMOS

Package Style: SOT23-6

- Features
- 50dB Linear Gain Control Range
 - 22dB Maximum Gain
 - Single 2.7V to 3.3V Supply
 - 35mA Supply Current
 - High Linearity

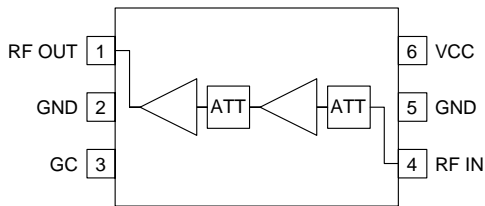

Functional Block Diagram

Ordering Information

RF2381	PCS/Cellular TDMA/CDMA/W-CDMA Linear Variable Gain Amplifier
RF2381 PCBA	Fully Assembled Evaluation Board

RF Micro Devices, Inc.
7628 Thorndike Road
Greensboro, NC 27409, USA

Tel (336) 664 1233
Fax (336) 664 0454
<http://www.rfmd.com>

RF2381

Absolute Maximum Ratings

Parameter	Rating	Unit
Supply Voltage	0 to +5.0	V _{DC}
DC Current	100	mA
Operating Ambient Temperature	-30 to +85	°C
Storage Temperature	-40 to +150	°C



Caution! ESD sensitive device.

RF Micro Devices believes the furnished information is correct and accurate at the time of this printing. However, RF Micro Devices reserves the right to make changes to its products without notice. RF Micro Devices does not assume responsibility for the use of the described product(s).

Parameter	Specification			Unit	Condition
	Min.	Typ.	Max.		
Overall					V _{CC} =2.8V, V _{GC} =2.0V, T=25°C
Usable Frequency Range		800 to 2100		MHz	
Linear Gain Control Range	50			dB	
Gain Control Slope		70		dB/V	
Input VSWR		1.5:1	2.5:1		Over entire gain control range
Output VSWR		1.5:1	2.5:1		Over entire gain control range
Output IP3	+23	+26		dBm	
Noise Figure		9		dB	Maximum gain
TDMA					V _{CC} =2.8V, V _{GC} =2.0V, T=25°C
Operating Frequency		1880		MHz	
Maximum Small Signal Gain	18	20	22	dB	
Maximum Average Output Power		+8		dBm	TDMA modulation; ACP _≤ -32dBc
Maximum Average Input Power		-9	-8	dBm	TDMA modulation; for any V _{GC} that gives P _{OUT} ≤+8dBm, ACP _≤ -32dBc, ALT _≤ -52dBc
Adjacent Channel Power		-33	-32	dBc	TDMA modulation; P _{OUT} ≤+8dBm and P _{IN} ≤-11dBm, at all V _{GC} .
		-61	-52	dBc	TDMA modulation; P _{OUT} ≤+8dBm and P _{IN} ≤-11dBm, at all V _{GC} .
CDMA					V _{CC} =2.8V, V _{GC} =2.0V, T=25°C
Operating Frequency		1880		MHz	
Maximum Small Signal Gain	18	20	22	dB	
Maximum Average Output Power		+6		dBm	CDMA modulation; V _{CC} =3.0V, maximum gain setting, ACP _≤ -52dBc.
Maximum Average Input Power		-13		dBm	CDMA modulation; for any V _{GC} that gives P _{OUT} ≤+6dBm, ACP _≤ -52dBc
Adjacent Channel Power		-53		dBc	CDMA modulation; V _{CC} =3.0V. P _{OUT} ≤+6dBm and P _{IN} ≤-13dBm, at all V _{GC} .
W-CDMA					V _{CC} =2.8V, V _{GC} =2.0V, T=25°C
Operating Frequency		1920 to 1980		MHz	
Small Signal Gain	17.5	19.5	22	dB	
Maximum Linear Output Power		+5		dBm	W-CDMA ACP _{<} -46dBc
Adjacent Channel Power			-46	dBc	W-CDMA modulation; P _{OUT} ≤+5dBm and P _{IN} <-12dBm
			-43	dBc	W-CDMA modulation; Over entire gain control range, P _{IN} <-17dBm
			-43	dBc	W-CDMA modulation; V _{GC} =1.0V, P _{IN} <-14dBm

Parameter	Specification			Unit	Condition
	Min.	Typ.	Max.		
Power Supply					T=25°C
Supply Voltage		2.8		V	Specifications
		2.7 to 3.3		V	Operating range
Gain Control Voltage (V_{GC})		0 to 2.2		V	
Supply Current		35		mA	$V_{CC}=2.8V, V_{GC}=2.2V$
		50		mA	$V_{CC}=3.3V, V_{GC}=2.2V$
		21		mA	$V_{CC}=2.8V, V_{GC}=0.4V$
V_{GC} Current	-2.0		+2.4	mA	$V_{GC}=0.4V$ to 2.2V

RF2381

Pin	Function	Description	Interface Schematic
1	RF OUT	RF output pin. This pin is DC-coupled and requires V_{CC} through a bias inductor sized accordingly to provide a high pass transformation with a series capacitor.	
2	GND	Ground connection. For best performance, keep traces physically short and connect immediately to ground plane.	
3	GC	Analog gain control pin. This pin controls the gain of the IC. Minimum gain occurs at $V_{GC} < 0.4V$ and maximum gain is achieved with $V_{GC} = 2.0V$. 50dB of linear gain control with little variation of input P_{1dB} is available.	
4	RF IN	RF input pin. This pin is DC-coupled.	
5	GND	Ground connection. For best performance, keep traces physically short and connect immediately to ground plane.	
6	VCC	Power supply. This pin should be connected to a regulated supply and requires a series inductor and bypass capacitor. Voltage is supplied through this pin to the first stage collector; this voltage also controls the bias. Gain may be tuned by adjusting the value of the feed inductor.	

Application Schematic 1850MHz to 1910MHz

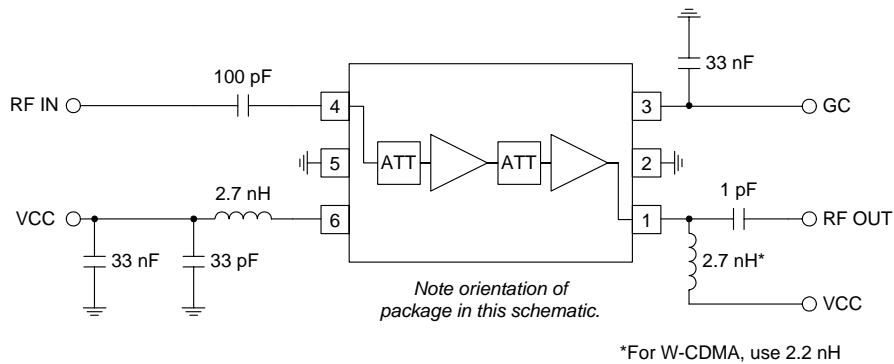

Evaluation Board Schematic

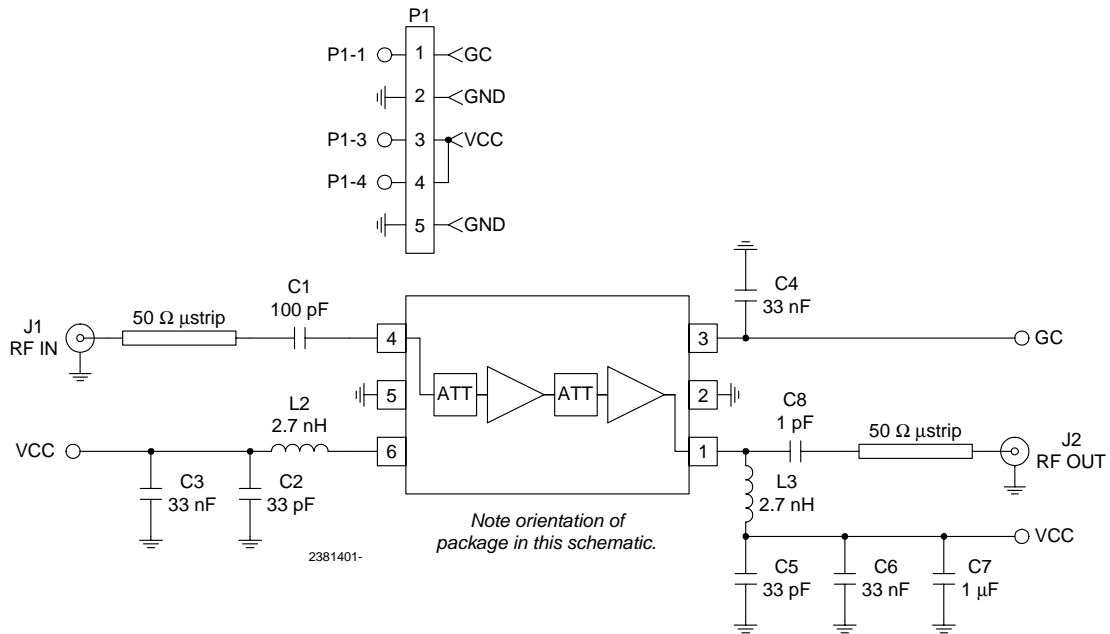

RF2381

Evaluation Board Layout Board Size 2.0" x 2.0"

Board Thickness 0.028", Board Material FR-4, Multi-Layer

4

GENERAL PURPOSE
AMPLIFIERS

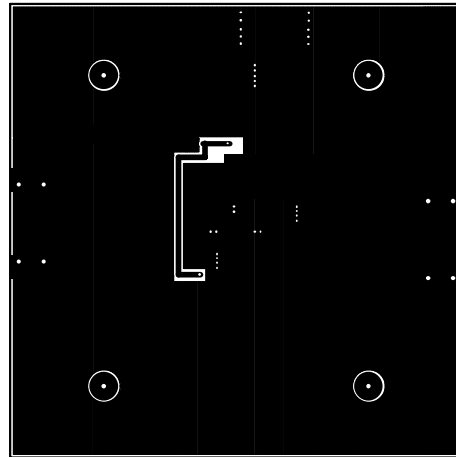
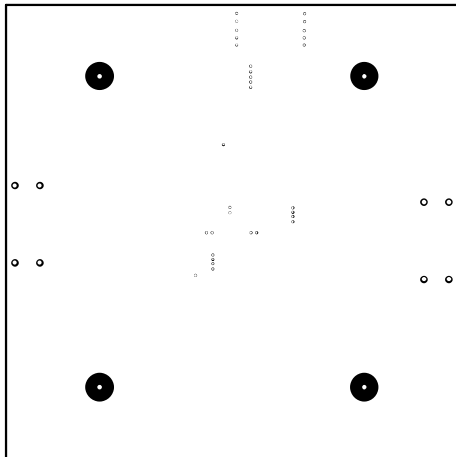
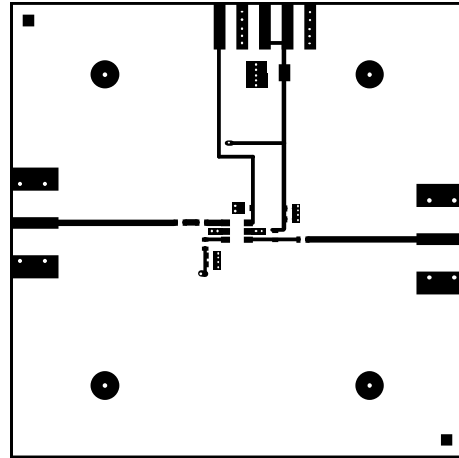
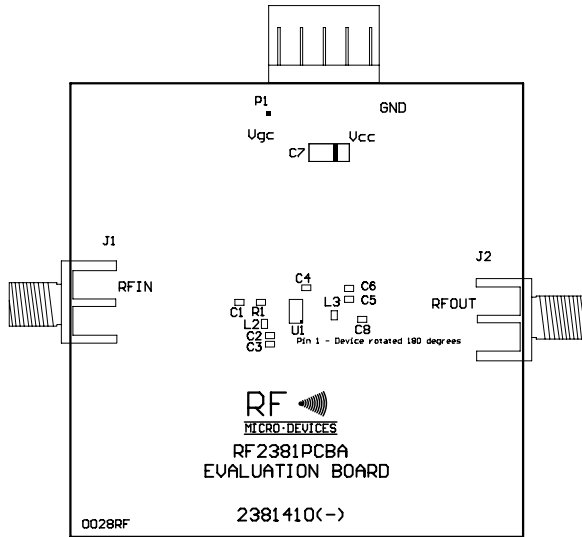

TDMA ACP versus P_{OUT} over Temperature,
 $P_{IN}=9\text{ dBm}$, $f=1880\text{ MHz}$, $V_{CC}=2.8\text{ V}$

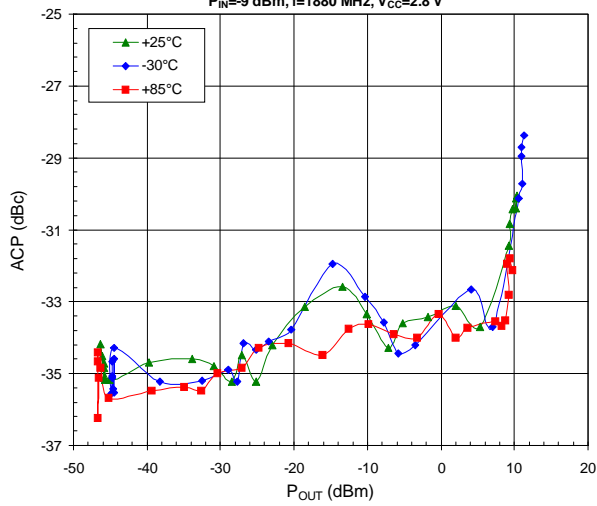

TDMA AltCP versus P_{OUT} over Temperature,
 $P_{IN}=9\text{ dBm}$, $f=1880\text{ MHz}$, $V_{CC}=2.8\text{ V}$

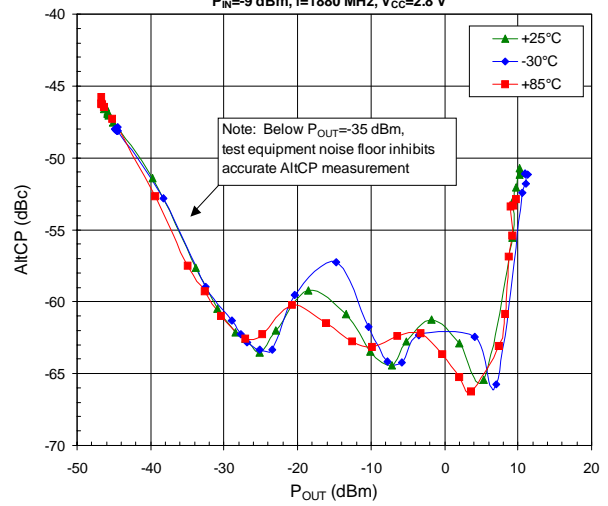

Supply Current versus Gain-Control Voltage over Temperature,
 $P_{IN}=9\text{ dBm}$, $F=1880\text{ MHz}$, $V_{CC}=2.8\text{ V}$

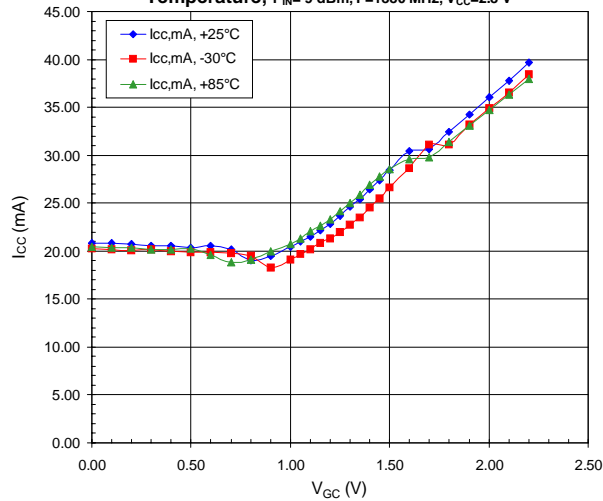

Gain versus Gain-Control Voltage over Temperature,
 $P_{IN}=9\text{ dBm}$, $F=1880\text{ MHz}$, $V_{CC}=2.8\text{ V}$

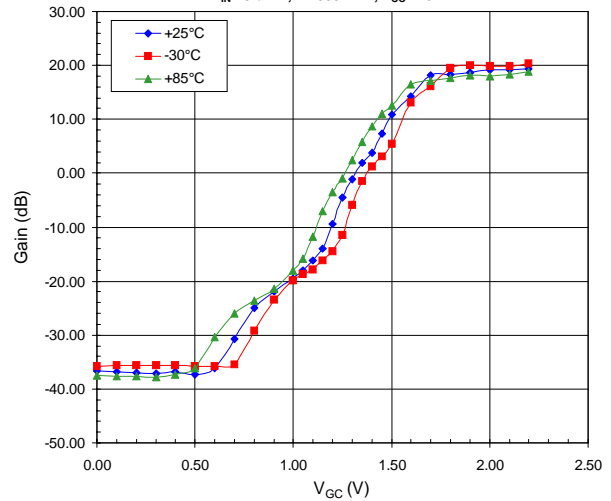

W-CDMA ACPR versus V_{GC} at Various Output Powers

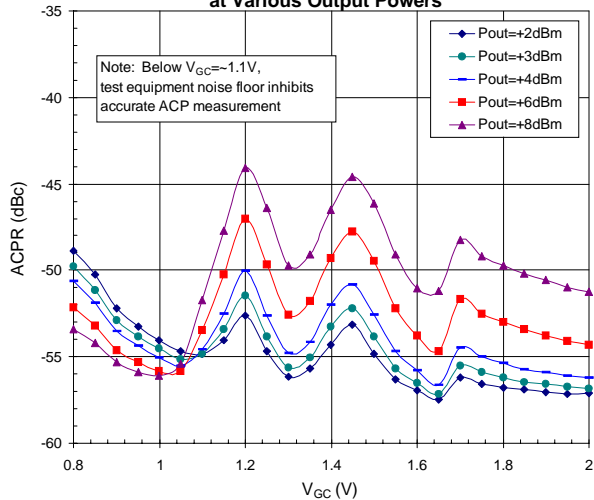

NF versus V_{GC} (RF Freq. 1950MHz, $V_{CC}=2.8\text{ V}$, $V_{GC}=2.0\text{ to }0.2\text{ V}$)

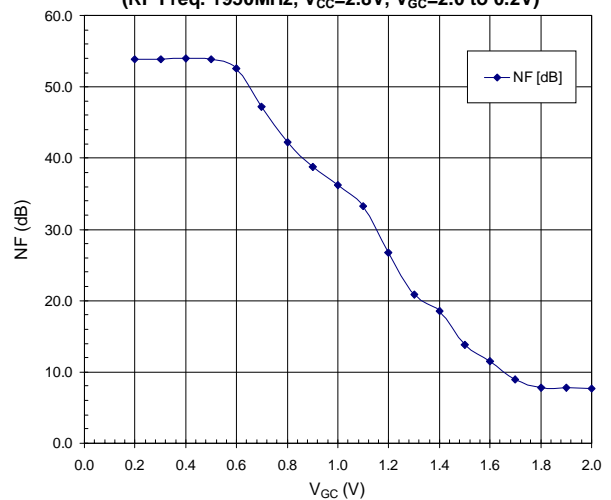

RF2381

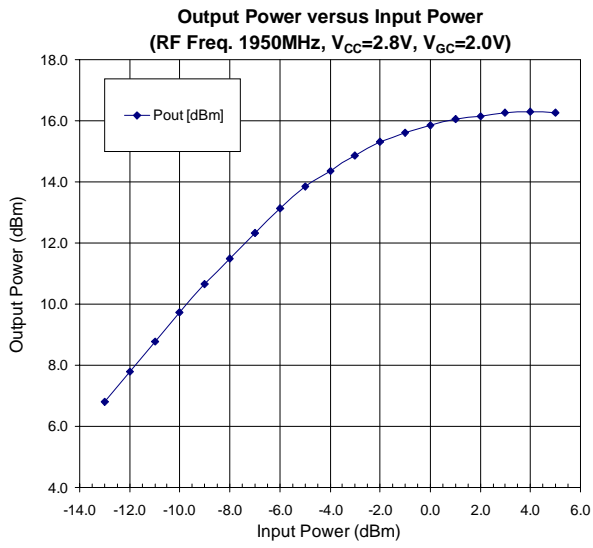

This datasheet has been download from:

www.datasheetcatalog.com

Datasheets for electronics components.