

Powerex, Inc., 200 Hillis Street, Youngwood, Pennsylvania 15697-1800 (412) 925-7272  
 Powerex, Europe, S.A. 428 Avenue G. Durand, BP107, 72003 Le Mans, France (43) 41.14.14

**Fast Recovery Rectifier**  
**650 Amperes Average**  
**1600 Volts**

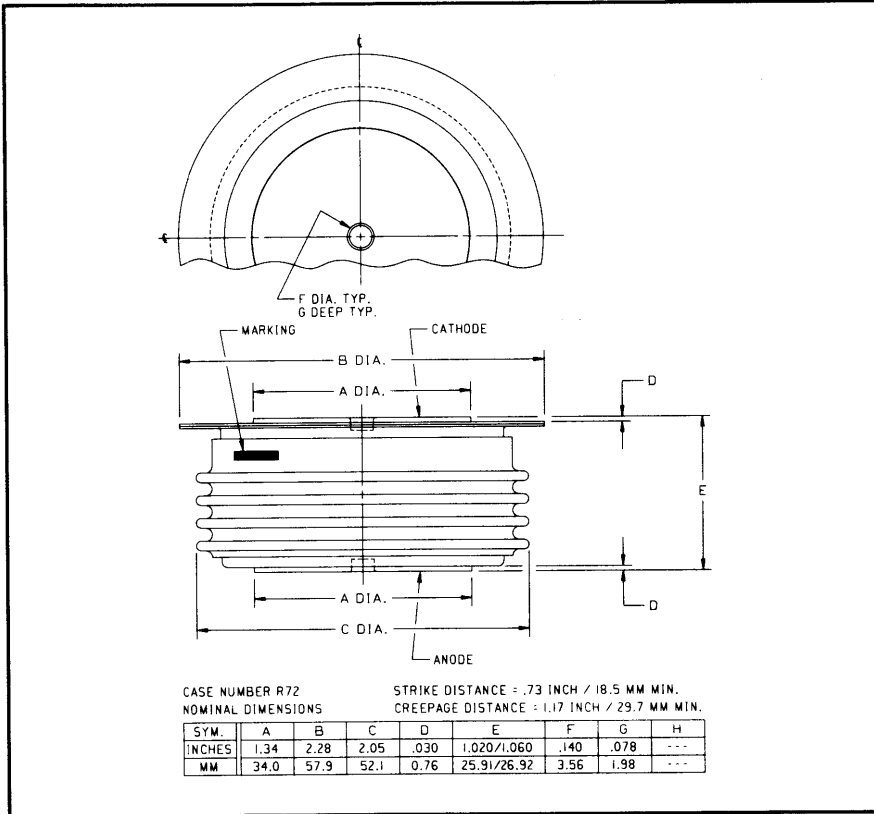

R722\_\_06 (Outline Drawing)

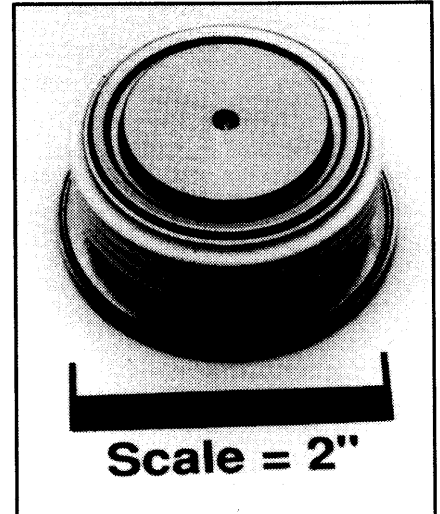

R722\_\_06  
 Fast Recovery Rectifier  
 650 Amperes Average, 1600 Volts

### Ordering Information:

Select the complete part number you desire from the following table:

| Type | Voltage              |      | Current            |      | Recovery Time            |      | Leads |      |
|------|----------------------|------|--------------------|------|--------------------------|------|-------|------|
|      | $V_{RRM}$<br>(Volts) | Code | $I_{F(av)}$<br>(A) | Code | $t_{rr}$<br>( $\mu$ sec) | Code | Case  | Code |
| R722 | 400                  | 04   | 650                | 06   | 2.0                      | ES   | R72   | 00   |
|      | 600                  | 06   |                    |      |                          |      |       |      |
|      | 800                  | 08   |                    |      |                          |      |       |      |
|      | 1000                 | 10   |                    |      |                          |      |       |      |
|      | 1200                 | 12   |                    |      |                          |      |       |      |
|      | 1400                 | 14   |                    |      |                          |      |       |      |
|      | 1600                 | 16   |                    |      |                          |      |       |      |

**Example:** Type R722 rated at 650A average with  $V_{RRM} = 1600V$ ,  
 Recovery Time = 2.0  $\mu$ sec, order as:

| Type    | Voltage |   | Current |   | Time | Leads |   |
|---------|---------|---|---------|---|------|-------|---|
| R 7 2 2 | 1       | 6 | 0       | 6 | ES   | O     | O |

### Features:

- Fast Recovery Times
- Soft Recovery Characteristics
- High Surge Current Ratings
- Special Selection of  $t_{rr}$  or  $Q_{rr}$  Available

### Applications:

- Inverters
- Choppers
- Transmitters
- Free Wheeling Diode

**R722 \_06**

**Fast Recovery Rectifier**

650 Amperes Average, 1600 Volts

**Absolute Maximum Ratings**

| Characteristics                                    | Symbol       | R722 _06         | Units              |
|--|--------------|------------------|--------------------|
| RMS Forward Current                                | $I_{F(rms)}$ | 1000             | Amperes            |
| Average Forward Current                            | $I_{F(av)}$  | 650              | Amperes            |
| One-half Cycle Surge Current                       | $I_{FSM}$    | 7500             | Amperes            |
| $I^2t$ (for Fusing), Times = 8.3 milliseconds      | $I^2t$       | 234000           | A <sup>2</sup> sec |
| Max. $I^2t$ Package (for Times = 8.3 milliseconds) | $I^2t$       | $80 \times 10^6$ | A <sup>2</sup> sec |
| Storage Temperature                                | $T_{stg}$    | -40 to +190      | °C                 |
| Operating Temperature                              | $T_j$        | -40 to +150      | °C                 |
| Mounting Force                                     |              | 2000 to 2400     | lbs                |

**Electrical and Thermal Characteristics**

| Characteristics                                 | Symbol            | Test Conditions  | R722 _06 | Units           |
|---|-------------------|--|----------|-----------------|
| <b>Current - Conducting State Maximums</b>      |                   |  |          |                 |
| Forward Voltage Drop                            | $V_{FM}$          | $T_j = 25^\circ\text{C}, I_{FM} = 1500\text{A}$  | 2.05     | Volts           |
| <b>Voltage - Blocking State Maximums</b>        |                   |  |          |                 |
| Repetitive Peak Reverse Voltage (Rated Limit)   | $V_{RRM}$         |  | 1600     | Volts           |
| Non-rep. Trans. Peak Rev. Voltage (Rated Limit) | $V_{RSM}$         | $t \leq 5.0\text{msec}$  | 1800     | Volts           |
| Reverse Leakage Current, mA peak                | $I_{RRM}$         | $T_j$ at max., $V_{RRM} = \text{Rated}$  | 50       | mA              |
| <b>Switching</b>                                |                   |  |          |                 |
| Maximum Reverse Recovery Time                   | $t_{rr}$          | $I_{FM} = 1500\text{A}, t_p = 190\mu\text{sec},$<br>$di_R/dt = 25\text{A}/\mu\text{sec}, T_C = 25^\circ\text{C}$ | 2.0      | $\mu\text{sec}$ |
| <b>Thermal</b>                                  |                   |  |          |                 |
| Maximum Resistance, Junction to Case            | $R_{\theta(j-c)}$ |  | 0.055    | °C/Watt         |
| Maximum Resistance, Case to Sink (Lubricated)   | $R_{\theta(c-s)}$ |  | 0.020    | °C/Watt         |

Powerex, Inc., 200 Hillis Street, Youngwood, Pennsylvania 15697-1800 (412) 925-7272  
 Powerex, Europe, S.A. 428 Avenue G. Durand, BP107, 72003 Le Mans, France (43) 41.14.14

**R722\_06**  
**Fast Recovery Rectifier**  
 650 Amperes Average, 1600 Volts

Reverse Recovery Wave Form

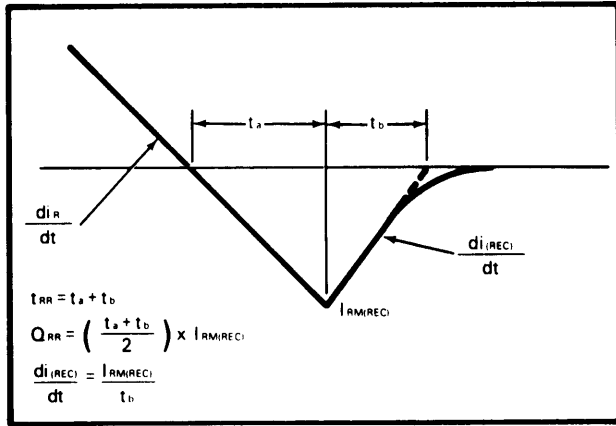

Typical Reverse Recovery Time Vs. Rate of Current Fall

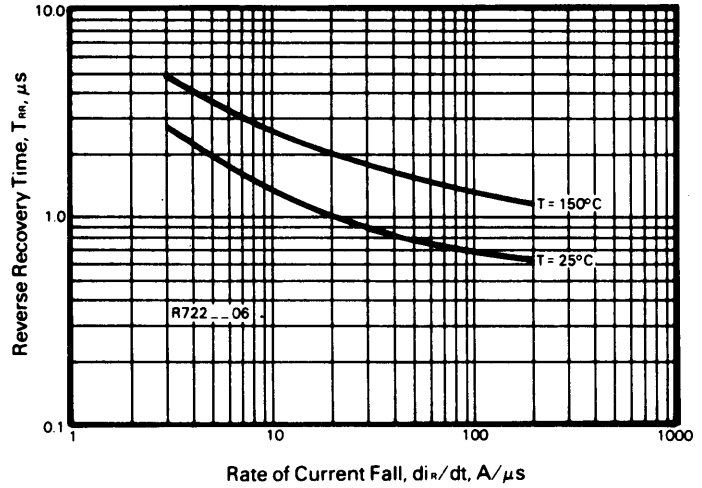

Typical Reverse Recovery Charge Vs. Rate of Current Fall

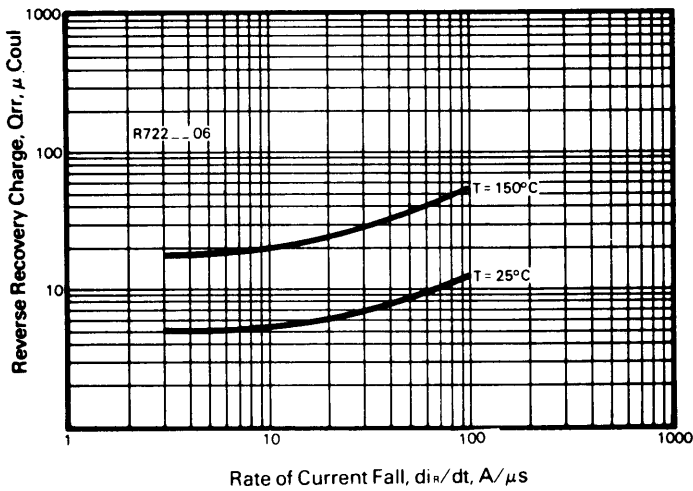

Typical Ratio of Current Recovery to Rate of Current Fall

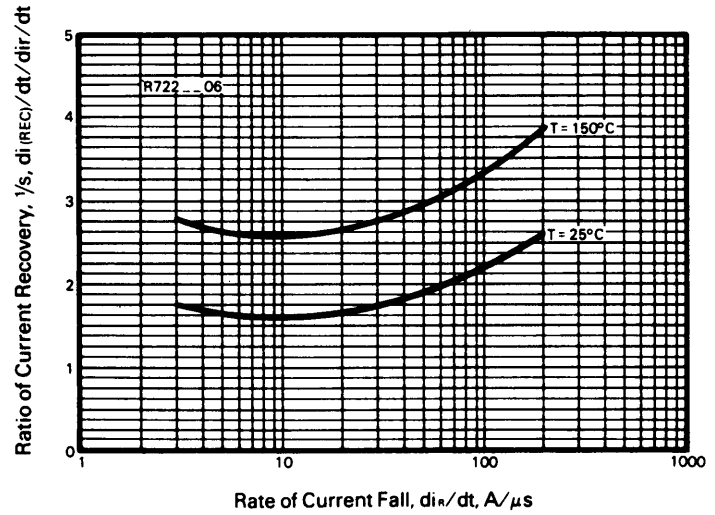

**R722\_06**  
**Fast Recovery Rectifier**  
 650 Amperes Average, 1600 Volts

Forward Current Vs. Forward Voltage Drop

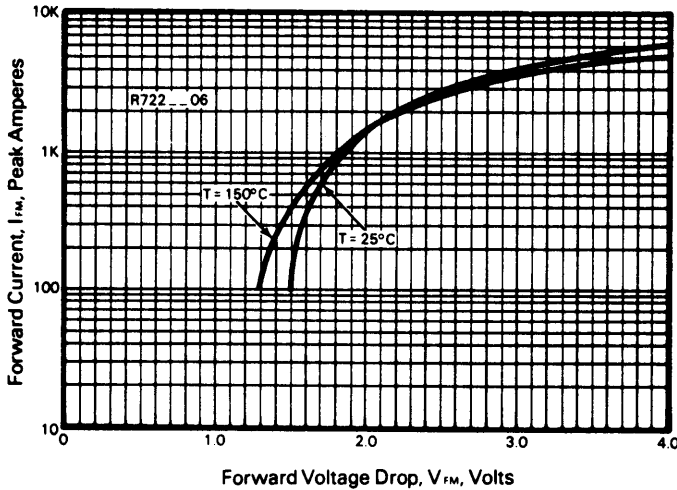

Transient Thermal Impedance Vs. Time

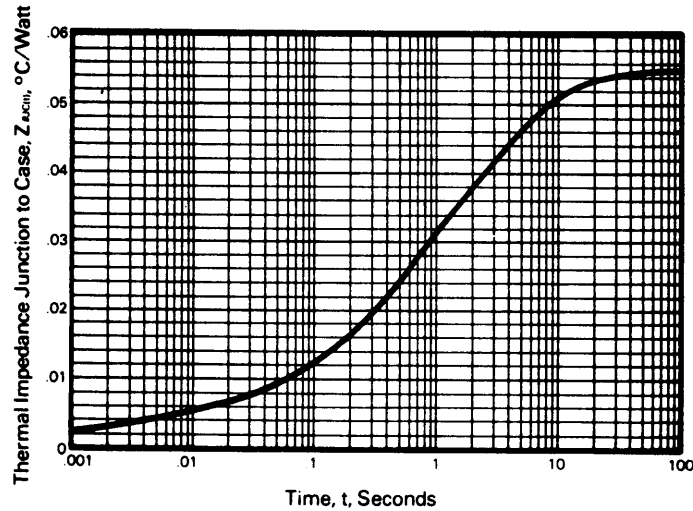

Energy Loss Per Pulse for Sinusoidal Pulses

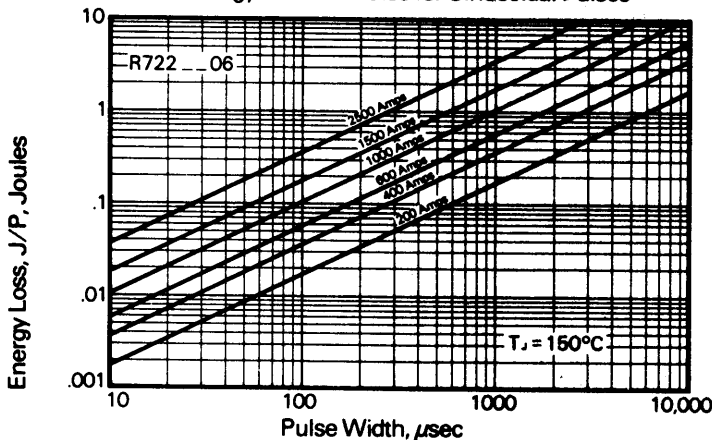

### Calculation of Fast Recovery Diodes and Allowable Case Temperature

1. Conduction Losses

$$P_{av(cond)} = J/P \times F$$

2. Reverse Recovery Losses (Approximate)

$$P_{av(sw)} = 1/4 \times V_R \times \frac{di_R}{dt} \times T_{rr}^2 \times \left( \frac{1/s}{1 + 1/s} \right)^2 \times F \times 1 \times 10^{-6}$$

3. Maximum Allowable Case Temperature

$$T_{C(max)} = T_j - (P_{av(cond)} + P_{av(sw)} \times R_{\theta(j-c)})$$

Where:

$P_{av(cond)}$  = Forward Conduction Power Loss in Watts

$P_{av(sw)}$  = Reverse Recovery Power Loss in Watts

J/P = Energy Loss per Pulse in Joules

F = Frequency in Hertz

$V_R$  = Steady State Reverse Operating Voltage in Volts

$di_R/dt$  = Rate of Decay of Forward Current in Amperes/ $\mu$ sec

$T_{rr}$  = Reverse Recovery Time in Microseconds

$\frac{1}{"S"}$  = Ratio of Recovery  $di/dt$  ( $\frac{di_F/dt}{di_R/dt}$ )

F = Operating Frequency in Hertz

$T_{C(max)}$  = Maximum Allowable Case Temperature in °C.

$T_j$  = Maximum Operating Junction Temperature in °C.

$R_{\theta(j-c)}$  = DC Junction to Case Thermal Impedance in °C/Watt.

This datasheet has been download from:

[www.datasheetcatalog.com](http://www.datasheetcatalog.com)

Datasheets for electronics components.