

---

# **SOT-23-5 PWM Step-up DC/DC CONVERTER**

**R1210N××2× SERIES**

**APPLICATION MANUAL**

### R1210N\*\*2\* SERIES

#### OUTLINE

The R1210NXX2C/XX2D Series are PWM step-up DC/DC Converter controllers, with high accuracy, low supply current by CMOS process.

Each of the R1210NXX2X Series consists of an oscillator, a PWM circuit, a reference voltage unit, an error amplifier, phase compensation circuit, resistors for voltage detection, a chip enable circuit, a controller against drastic load transient and an output voltage detector. A low ripple, high efficiency step-up DC/DC converter can be composed of this IC with only four external components, or an inductor, a diode, a transistor and a capacitor.

The R1210NXX2X Series can detect drastic change of output voltage with a circuit controller, the load transient response is improved.

Each of the R1210NXX2X Series has a driver pin, or 'EXT' pin for external transistor. By connecting a power transistor with low ON-resistance to EXT pin, a large current flows through an inductor, thus, large output current can be supplied.

The built-in chip enable circuit can make the standby mode with ultra low quiescent current.

Since the package for these ICs is small SOT-23-5, high density mounting of the ICs on board is possible.

#### FEATURES

- External Components ..... Only an inductor, a diode, a capacitor, and a transistor
- Standby Current ..... TYP. 0 $\mu$ A
- Low Temperature-Drift Coefficient of Output Voltage..... TYP.  $\pm$ 100ppm/ $^{\circ}$ C
- Output Voltage ..... Stepwise Setting with a step of 0.1V in the range of 2.2V to 6.0V
- Two choices of Basic Oscillator Frequency ..... 100kHz (XX2C), 180kHz (XX2D)
- Small Package ..... SOT-23-5 (Mini-mold)
- Low Ripple, Low Noise
- Oscillator Start-up Voltage ..... MAX. 0.8V

#### APPLICATIONS

- Power source for battery-powered equipment.
- Power source for portable communication appliances, cameras, VCRs
- Power source for appliances which require higher voltage than battery voltage.

## BLOCK DIAGRAM

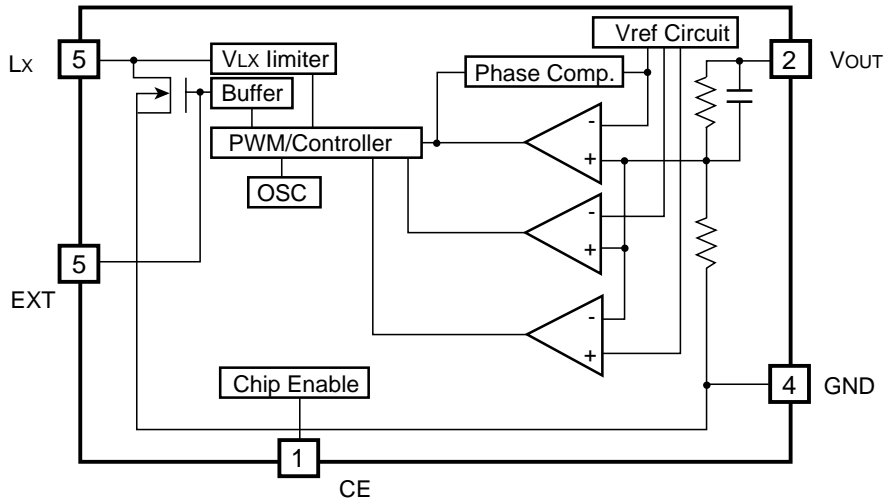

## SELECTION GUIDE

In the R1210N Series, the output voltage, the oscillator frequency, the optional function, and the taping type for the ICs can be selected at the user's request.

The selection can be made by designating the part number as shown below;

R1210NXXXX-XX  
 ↑ ↑↑ ↑  
 a bc d

Code	Contents
a	Setting Output Voltage( $V_{OUT}$ ): Stepwise setting with a step of 0.1V in the range of 2.2V to 6.0V
b	Designation of Driver 2: External Tr. Driver
c	Designation of Oscillator Frequency C: 100kHz D: 180kHz
d	Designation of Taping Type; Ex.: TR, TL (refer to Taping Specification) "TR" is prescribed as a standard.

## PIN CONFIGURATION

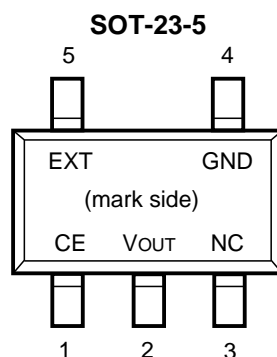

## PIN DESCRIPTION

Pin No.	Symbol	Description
1	CE	Chip Enable Pin
2	V <sub>OUT</sub>	Pin for Output Voltage
3	NC	No Connection
4	GND	Ground Pin
5	EXT	External Transistor Drive Pin

## ABSOLUTE MAXIMUM RATINGS

Symbol	Item	Rating	Unit
V <sub>OUT</sub>	V <sub>OUT</sub> Pin Output Voltage	9	V
V <sub>EXT</sub>	EXT Pin Output Voltage	-0.3~V <sub>OUT</sub> +0.3	V
V <sub>CE</sub>	CE Pin Input Voltage	9	V
I <sub>EXT</sub>	EXT Pin Inductor Drive Output Current	±40	mA
PD	Power Dissipation	250	mW
T <sub>opt</sub>	Operating Temperature Range	-40~+85	°C
T <sub>stg</sub>	Storage Temperature Range	-55~+125	°C

## ELECTRICAL CHARACTERISTICS

## • R1210NXX2

(Topt=25°C)

Symbol	Item	Conditions	MIN.	TYP.	MAX.	Unit
$V_{OUT}$	Output Voltage	$V_{IN} = V_{SET} \times 0.6, I_{OUT} = 1mA$	$\times 0.975$		$\times 1.025$	V
$V_{IN}$	Maximum Input Voltage				8	V
$\Delta V_{OUT}/\Delta T$	Step-up Output Voltage Temperature Coefficient	$-40^{\circ}C \leq T_{opt} \leq 85^{\circ}C$		$\pm 100$		ppm/ °C
$V_{START}$	Start-up Voltage	$V_{IN} = 0V \rightarrow 2V$			0.8	V
$I_{DD2}$	Supply Current 2	$V_{OUT} = V_{CE} = V_{SET} + 0.5V$		10	15	$\mu A$ (xx2C)
				15	22	$\mu A$ (xx2D)
Istandby	Supply Current 3(Standby)	$V_{OUT} = 6.5V, V_{CE} = 0V$			0.5	$\mu A$
$I_{DD1}$	Supply Current1	$V_{OUT} = V_{SET} \times 0.96$ EXT at no load $2.2V \leq V_{set} \leq 2.4V$		18	35	$\mu A$ (xx2C)
				23	45	$\mu A$ (xx2D)
		$V_{OUT} = V_{SET} \times 0.96$ EXT at no load $2.5V \leq V_{set} \leq 3.0V$		20	40	$\mu A$ (xx2C)
				25	50	$\mu A$ (xx2D)
		$V_{OUT} = V_{SET} \times 0.96$ EXT at no load $3.1V \leq V_{set} \leq 3.9V$		25	50	$\mu A$ (xx2C)
				30	60	$\mu A$ (xx2D)
		$V_{OUT} = V_{SET} \times 0.96$ EXT at no load $4V \leq V_{set} \leq 4.4V$		30	60	$\mu A$ (xx2C)
				35	70	$\mu A$ (xx2D)
		$V_{OUT} = V_{SET} \times 0.96$ EXT at no load $4.5V \leq V_{set} \leq 4.9V$		35	70	$\mu A$ (xx2C)
				40	80	$\mu A$ (xx2D)

Symbol	Item	Conditions	MIN.	TYP.	MAX.	Unit
IDD1	Supply Current1	$V_{OUT}=V_{SET}\times 0.96$ EXT at no load $5V \leq V_{set} \leq 5.4V$		45	90	$\mu A$ (xx2C)
				50	100	$\mu A$ (xx2D)
		$V_{OUT}=V_{SET}\times 0.96$ EXT at no load $5.5V \leq V_{set} \leq 6.0V$		50	100	$\mu A$ (xx2C)
				55	110	$\mu A$ (xx2D)
IDD2	Supply Current2	$V_{OUT}=V_{CE}=V_{SET}+0.5V$		10	15	$\mu A$ (xx2C)
				15	22	$\mu A$ (xx2D)
IEXTH	EXT "H" Output Current	$2.2V \leq V_{SET} \leq 2.5V,$ $V_{EXT}=V_{OUT}-0.4V$			-1.0	mA
		$2.6V \leq V_{SET} \leq 3.0V,$ $V_{EXT}=V_{OUT}-0.4V$			-2.0	
		$3.1V \leq V_{SET} \leq 3.5V,$ $V_{EXT}=V_{OUT}-0.4V$			-2.5	
		$3.6V \leq V_{SET} \leq 4.0V,$ $V_{EXT}=V_{OUT}-0.4V$			-3.0	
		$4.1V \leq V_{SET} \leq 4.5V,$ $V_{EXT}=V_{OUT}-0.4V$			-3.5	
		$4.6V \leq V_{SET} \leq 5.0V,$ $V_{EXT}=V_{OUT}-0.4V$			-4.0	
		$5.1V \leq V_{SET} \leq 5.5V,$ $V_{EXT}=V_{OUT}-0.4V$			-4.5	
		$5.6V \leq V_{SET} \leq 6.0V,$ $V_{EXT}=V_{OUT}-0.4V$			-5.0	
fosc	Maximum Oscillator Frequency	$V_{OUT}=V_{CE}=V_{SET}\times 0.96$	80	100	120	kHz (xx2C)
			144	180	216	kHz (xx2D)

Symbol	Item	Conditions	MIN.	TYP.	MAX.	Unit
$\Delta f_{osc}/\Delta T$	Oscillator Frequency Temperature Coefficient	$-40^{\circ}\text{C} \leq T_{opt} \leq 85^{\circ}\text{C}$		0.5		kHz/ $^{\circ}\text{C}$ (xx2C)
				0.6		kHz/ $^{\circ}\text{C}$ (xx2D)
Maxdty	Oscillator Maximum Duty Cycle	$V_{OUT} = V_{CE} = V_{SET} \times 0.96$ , ( $V_{EXT}$ : "H" side)	70	85	97	%
$I_{EXTL}$	EXT "L" Output Current	$2.2\text{V} \leq V_{SET} \leq 2.5\text{V}, V_{EXT} = 0.4\text{V}$	1.0			mA
		$2.6\text{V} \leq V_{SET} \leq 3.0\text{V}, V_{EXT} = 0.4\text{V}$	2.0			
		$3.1\text{V} \leq V_{SET} \leq 3.5\text{V}, V_{EXT} = 0.4\text{V}$	2.5			
		$3.6\text{V} \leq V_{SET} \leq 4.0\text{V}, V_{EXT} = 0.4\text{V}$	3.0			
		$4.1\text{V} \leq V_{SET} \leq 4.5\text{V}, V_{EXT} = 0.4\text{V}$	3.5			
		$4.6\text{V} \leq V_{SET} \leq 5.0\text{V}, V_{EXT} = 0.4\text{V}$	4.0			
		$5.1\text{V} \leq V_{SET} \leq 5.5\text{V}, V_{EXT} = 0.4\text{V}$	4.5			
		$5.6\text{V} \leq V_{SET} \leq 6.0\text{V}, V_{EXT} = 0.4\text{V}$	5.0			
$V_{CEH}$	CE "H" Input Voltage	$V_{OUT} = V_{SET} \times 0.96$	0.9			V
$V_{CEL}$	CE "L" Input Voltage	$V_{OUT} = V_{SET} \times 0.96$			0.3	V
$I_{CEH}$	CE "H" Input Current	$V_{OUT} = V_{CE} = 6.5\text{V}$	-0.1	0	0.1	$\mu\text{A}$
$I_{CEL}$	CE "L" Input Current	$V_{OUT} = 6.5\text{V}, V_{CE} = 0\text{V}$	-0.1	0	0.1	$\mu\text{A}$

\*Note:  $V_{SET}$  means setting Output Voltage.

## TEST CIRCUITS

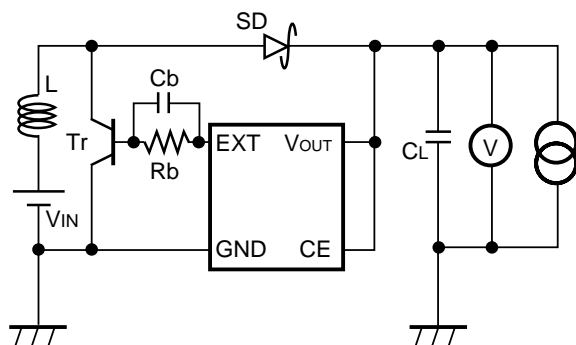

**Test Circuit 1**

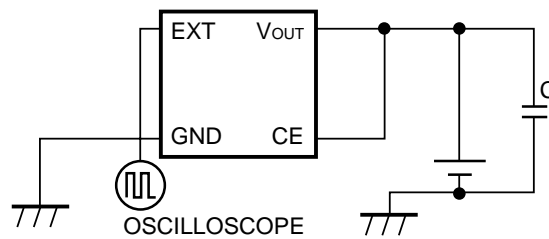

**Test Circuit 2**

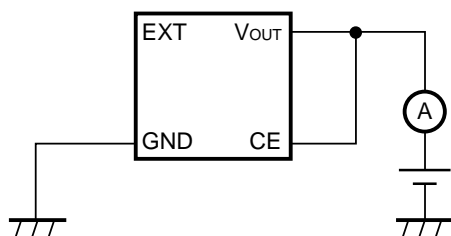

**Test Circuit 3**

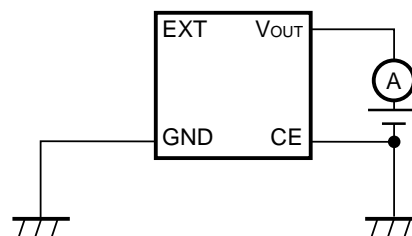

**Test Circuit 4**

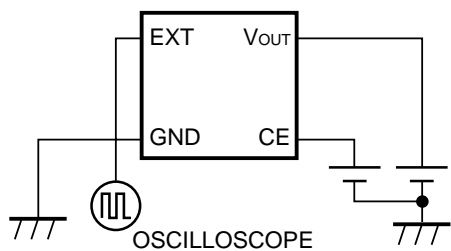

**Test Circuit 5**

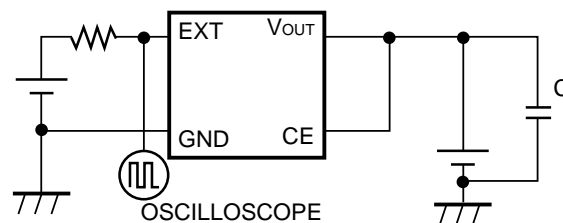

**Test Circuit 6**

Inductor (L)	: 27 $\mu$ H (Sumida Electric Co., Ltd. CD104)
Diode (SD)	: RB491D (Rohm, Schottky Type)
Capacitor (CL)	: 47 $\mu$ F $\times$ 2 (Tantalum Type)
Transistor (Tr)	: 2SD1628G
Base Resistor (Rb)	: 300 $\Omega$
Base Capacitor (Cb)	: 0.01 $\mu$ F (Ceramic Type)



## TYPICAL CHARACTERISTICS

### 1) Output Voltage vs. Output Current

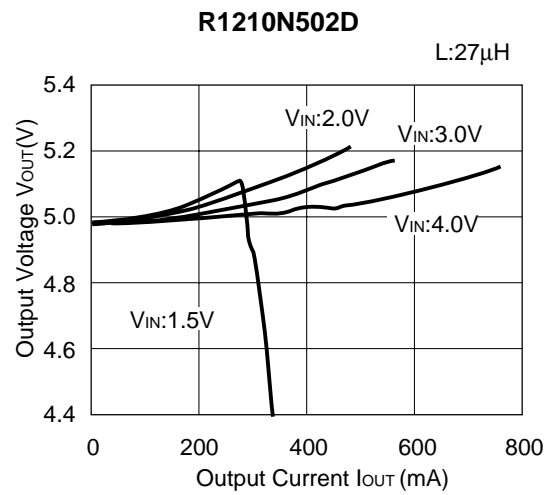
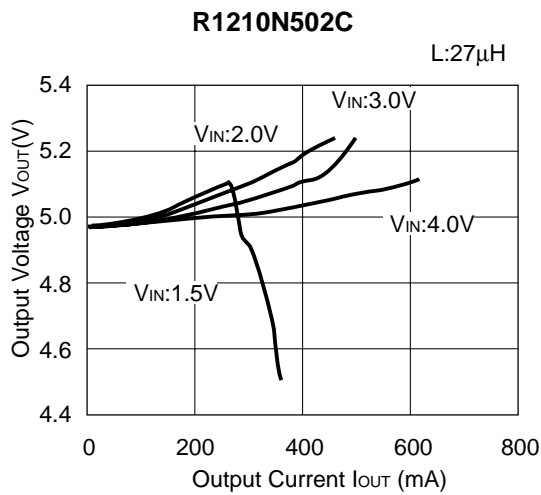
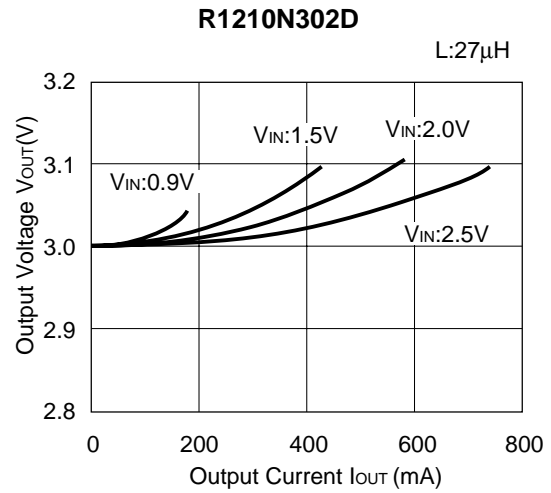
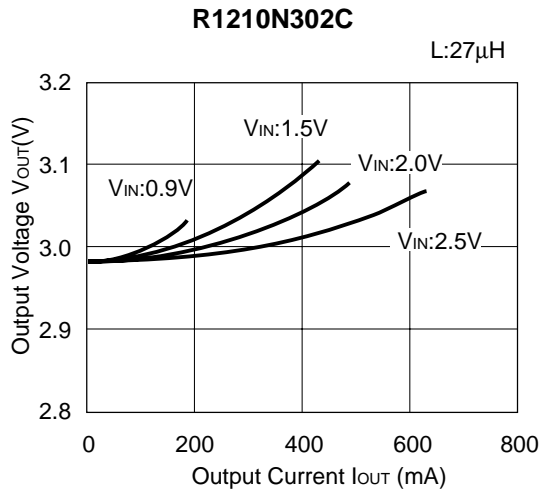

### 2) Efficiency vs. Output Current

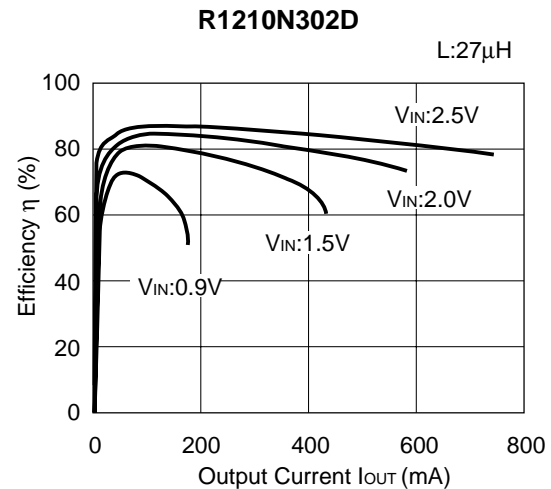
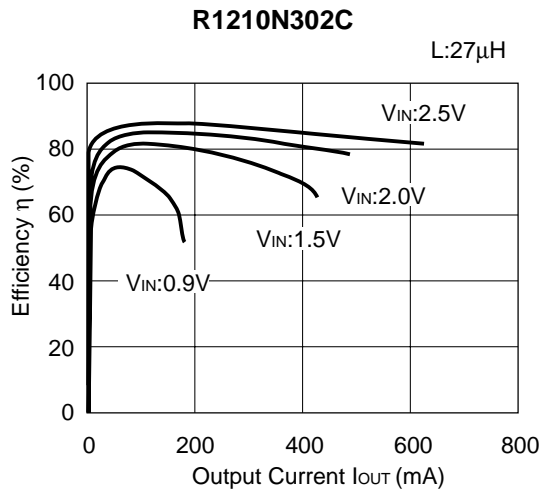

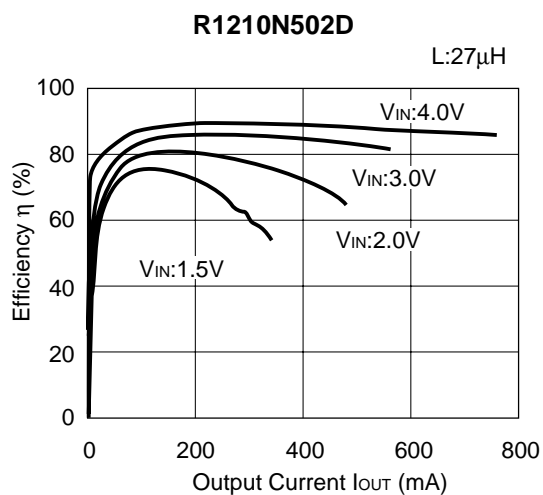
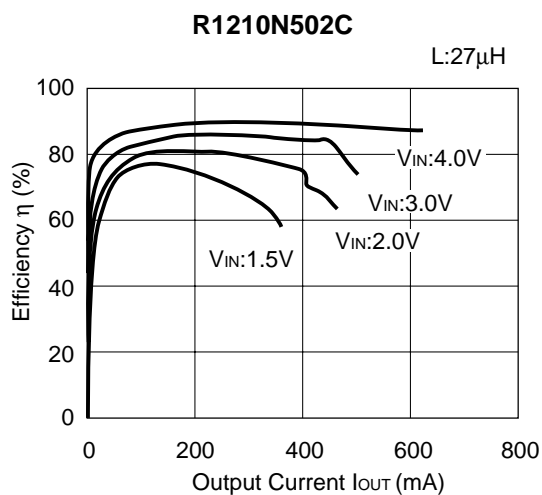

3) Ripple Voltage vs. Output Current

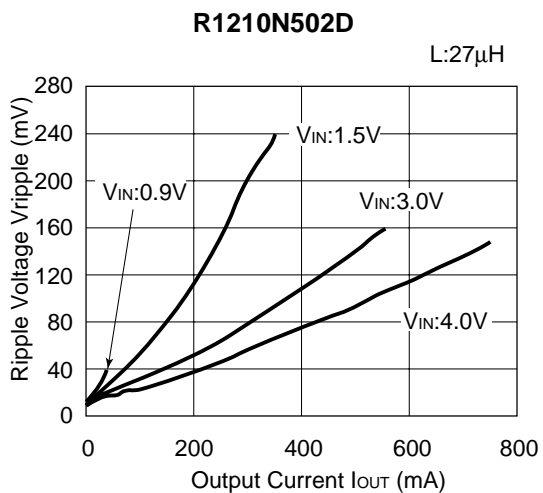
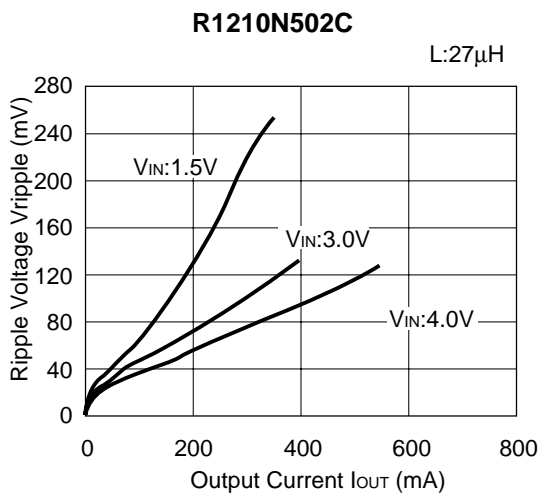
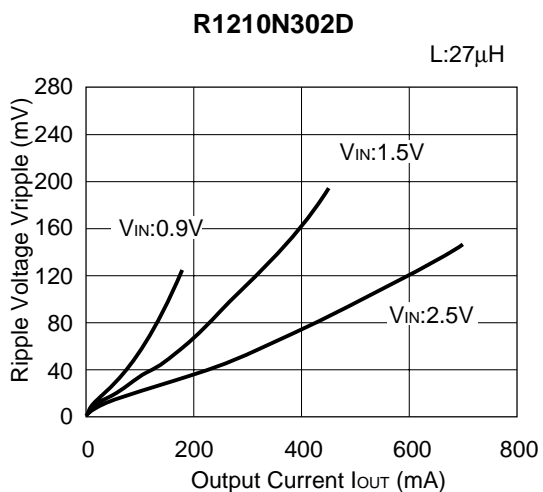
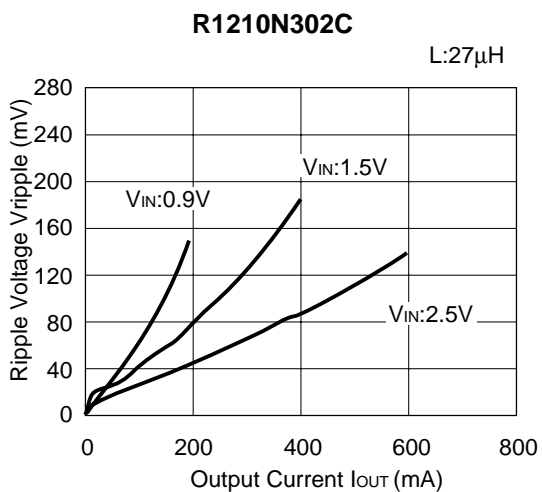

4) Start-up Voltage/ Hold-on Voltage vs. Output Current (Topt=25°C)

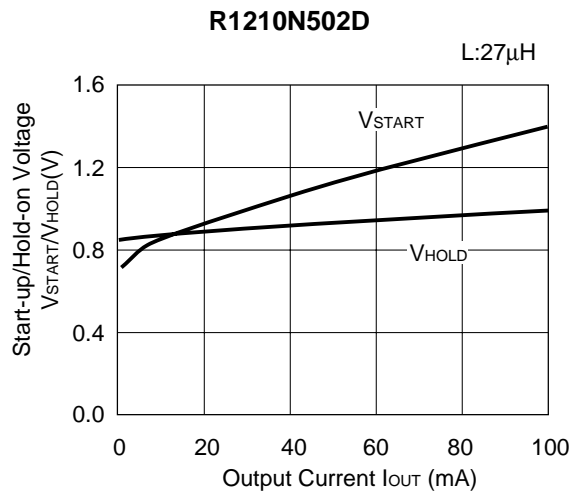
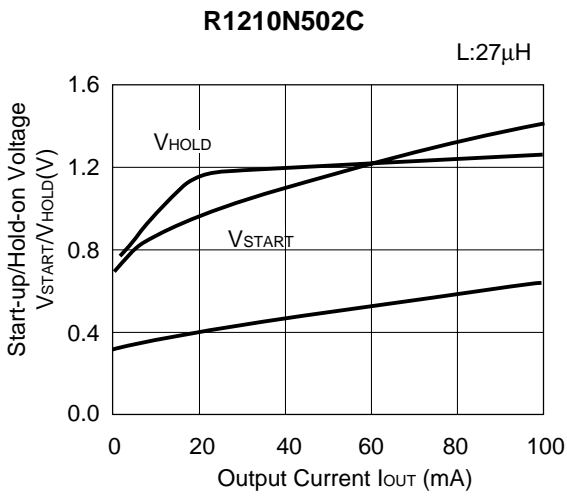
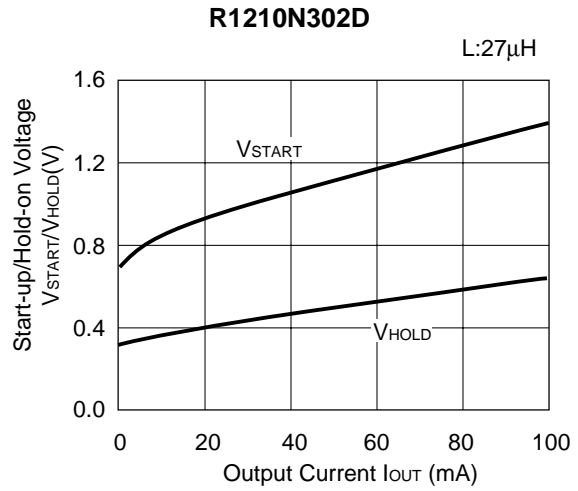
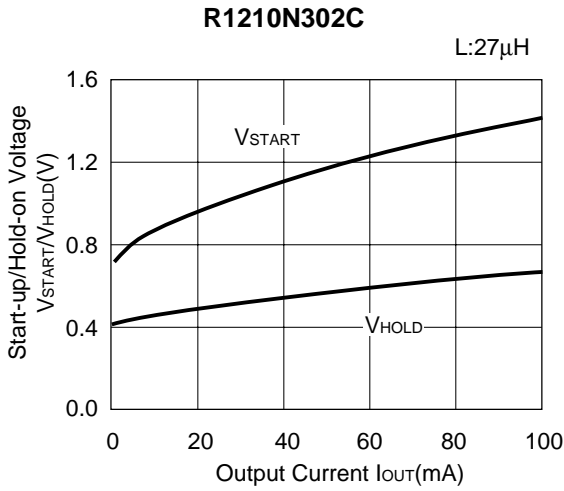

5) Output Voltage vs. Temperature

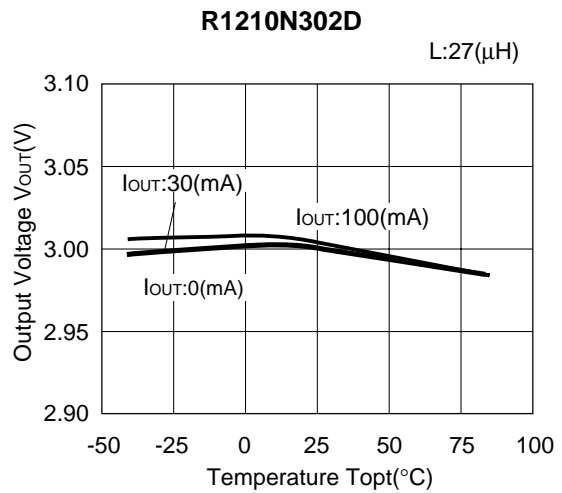
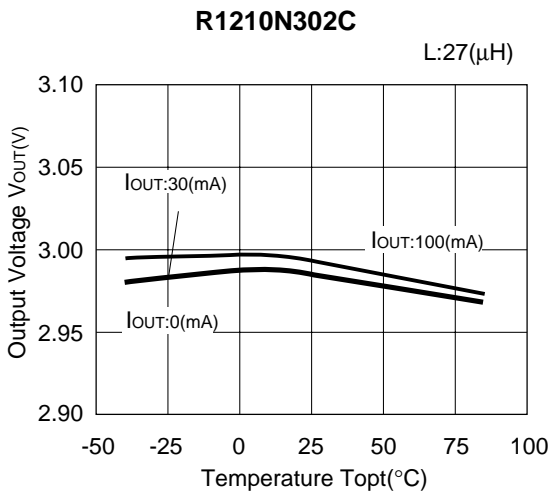

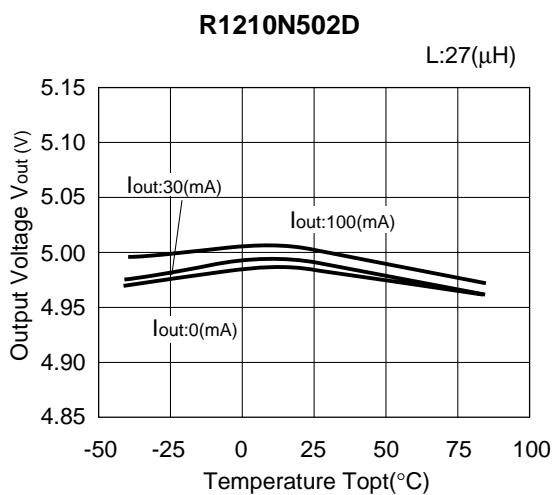
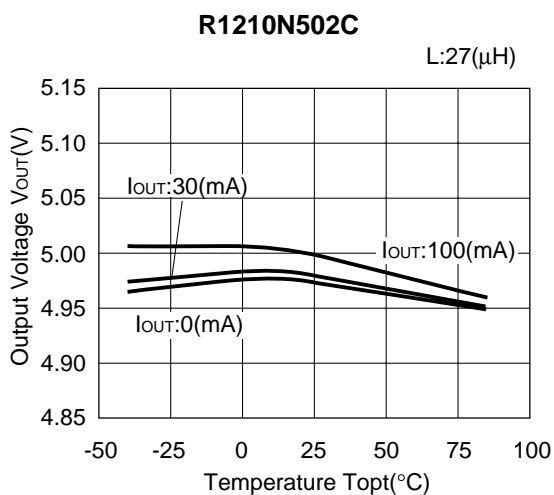

6) Supply Current I<sub>ss1</sub> vs. Temperature

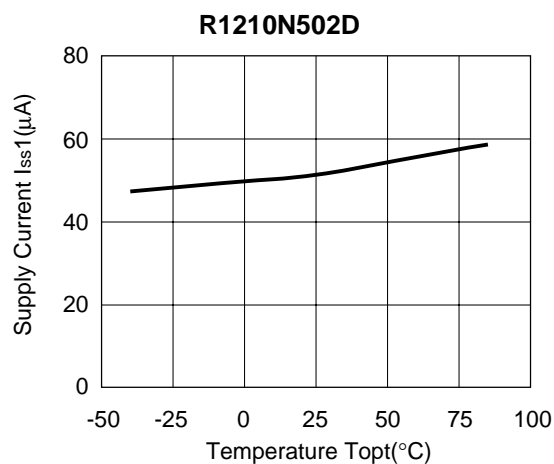
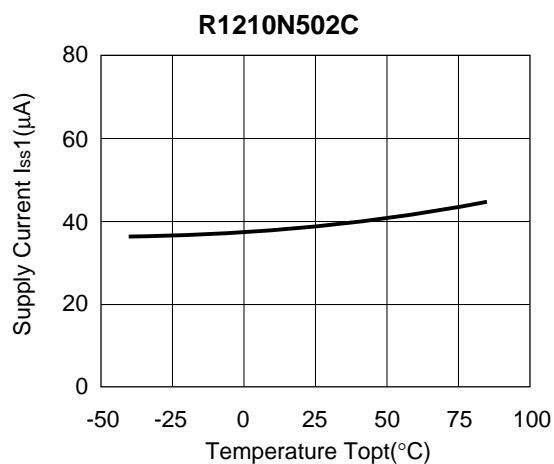
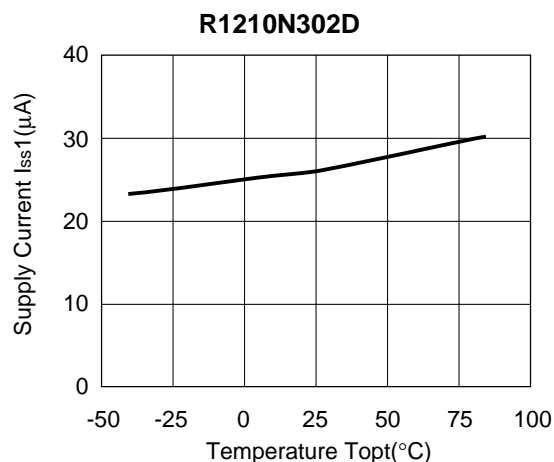
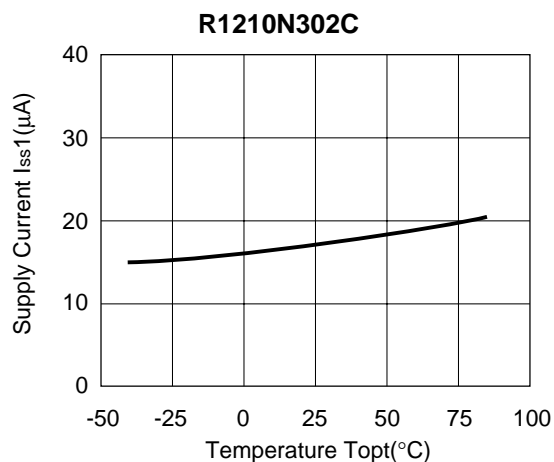

7) Supply Current 2 vs. Temperature

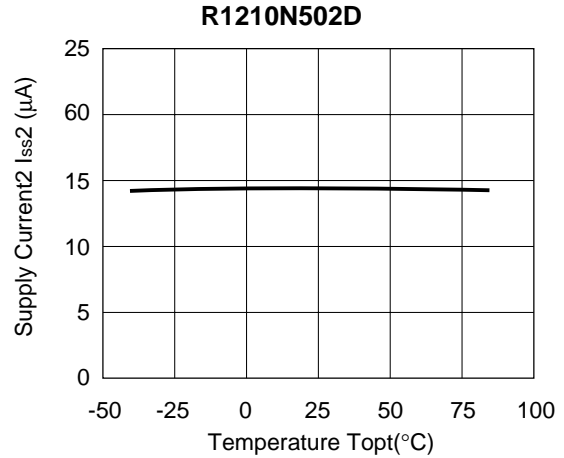
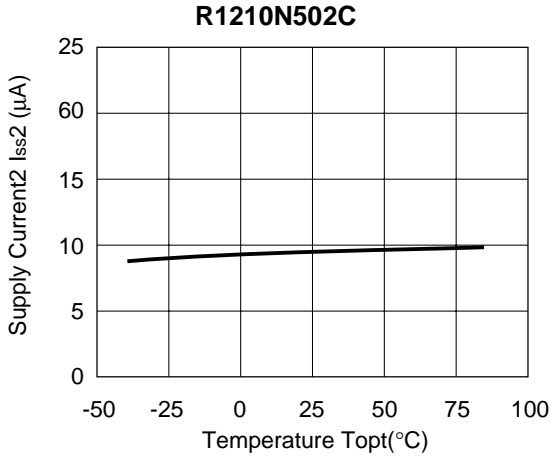
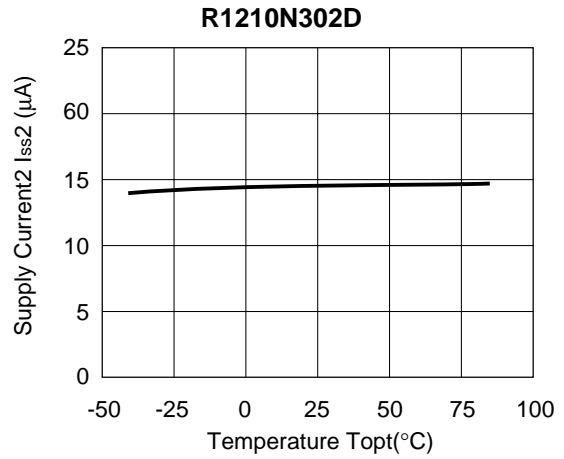
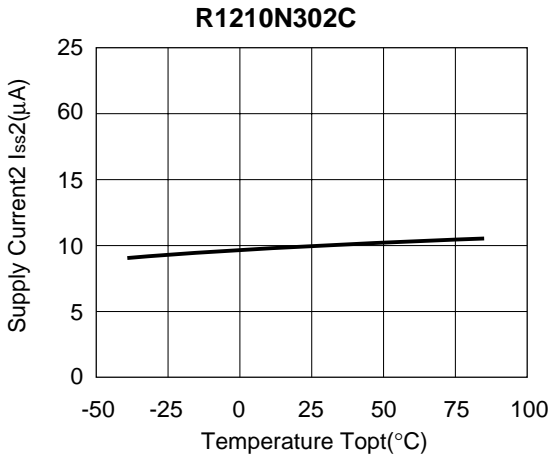

8) Supply Current 3 vs. Temperature

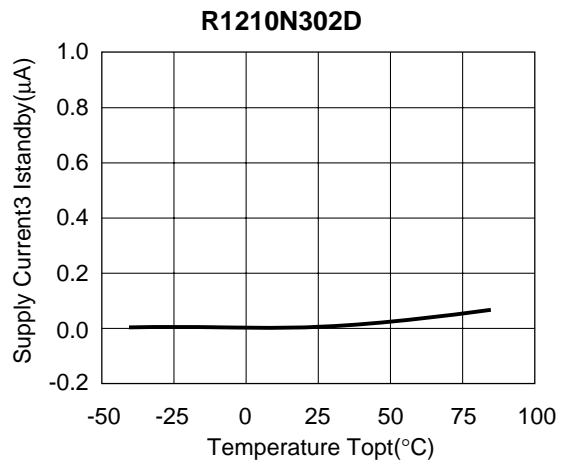
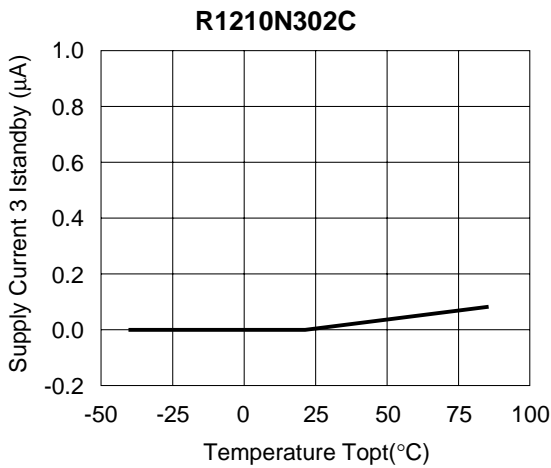

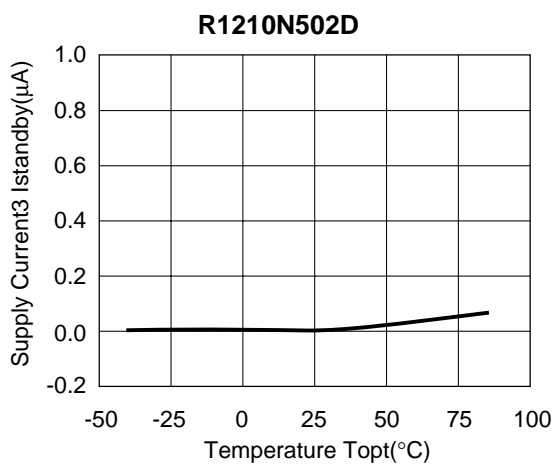
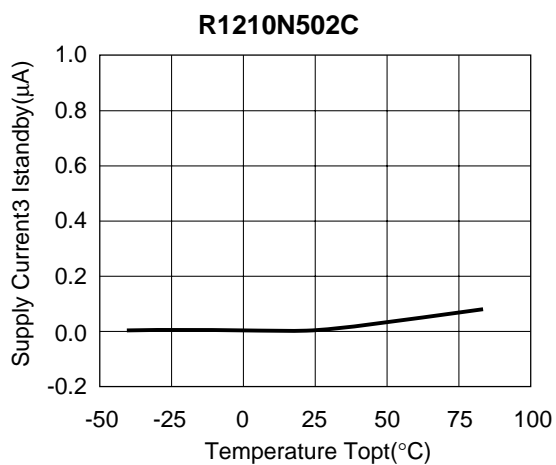

9) Oscillator Frequency vs. Temperature

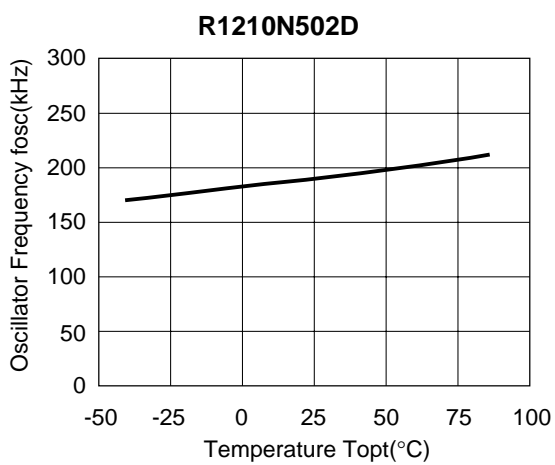
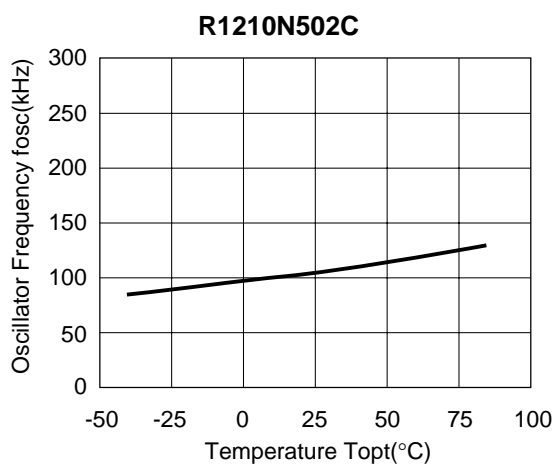
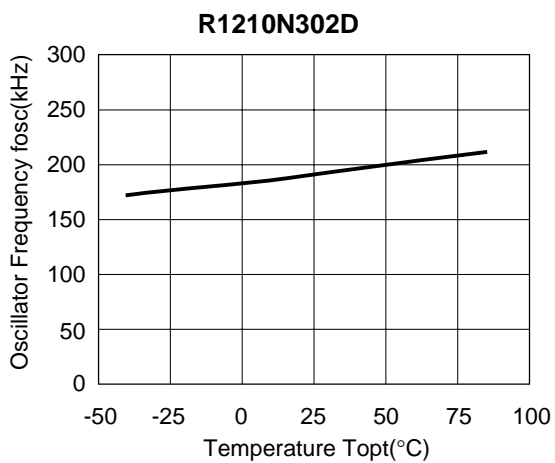
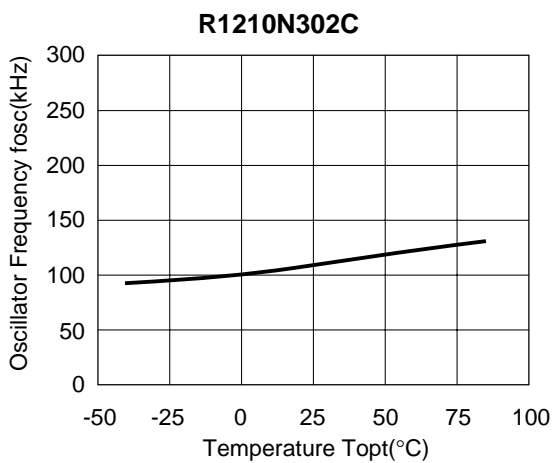

10) Maximum Duty Cycle vs. Temperature

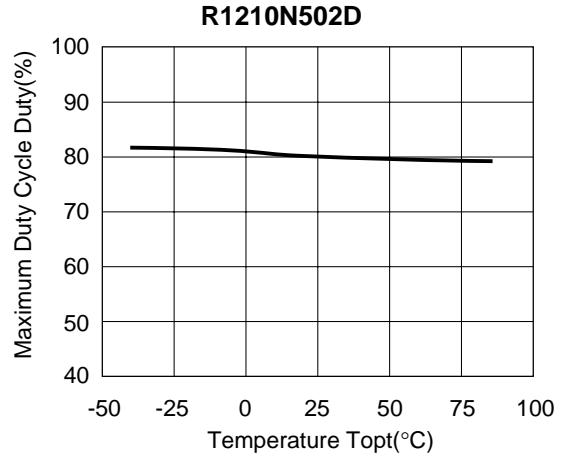
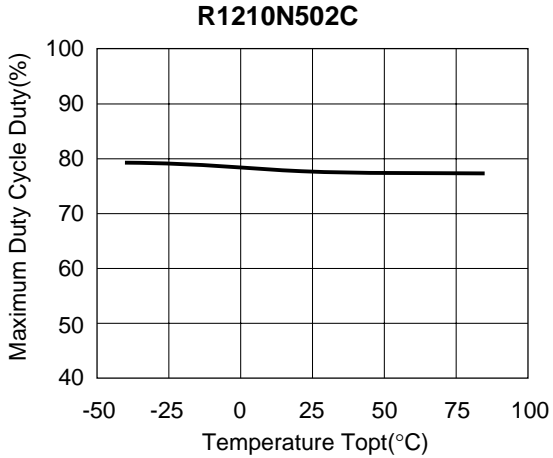
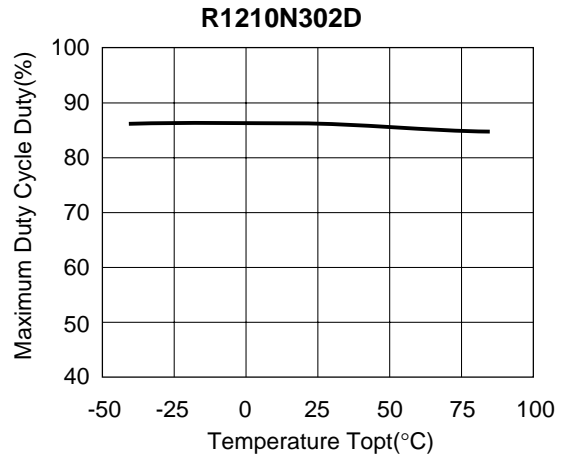
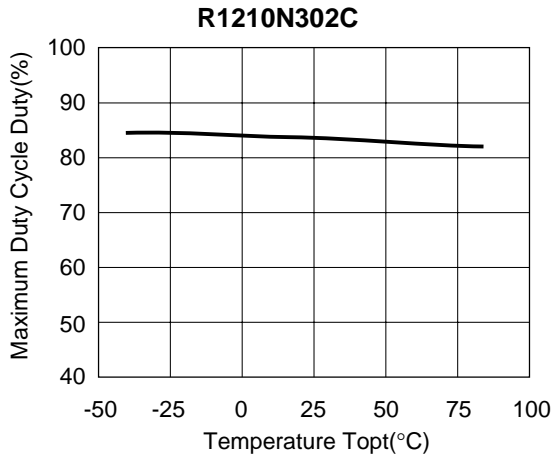

11) EXT "H" Output Current vs. Temperature

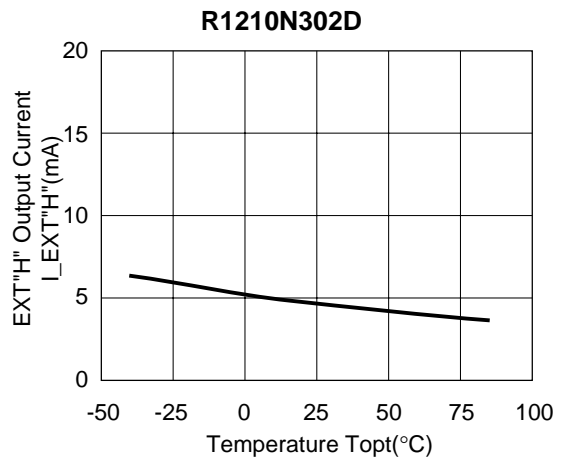
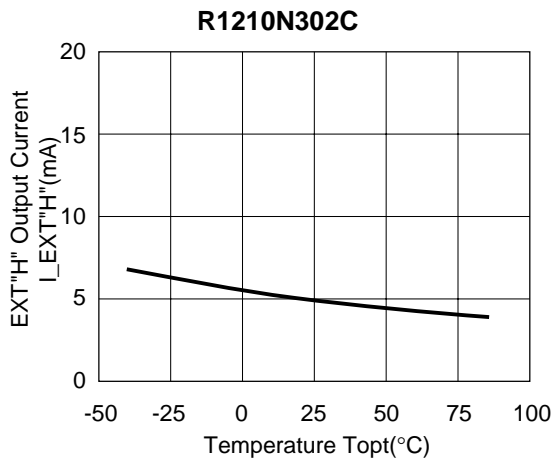

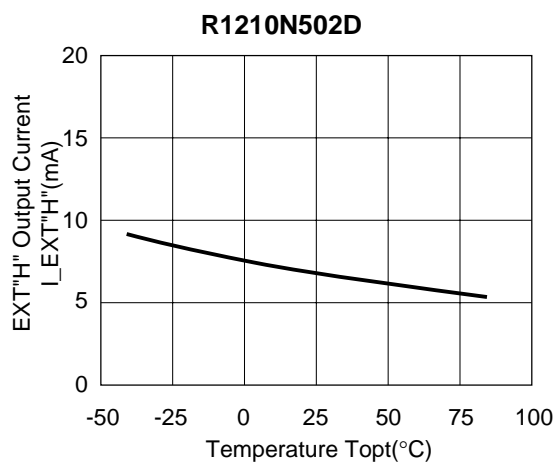
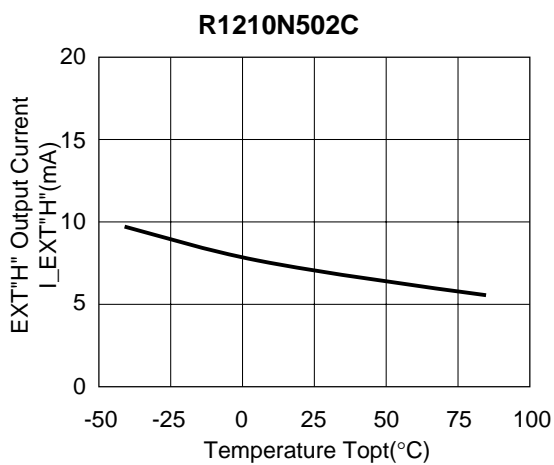

12) EXT "L" Output Current vs. Temperature

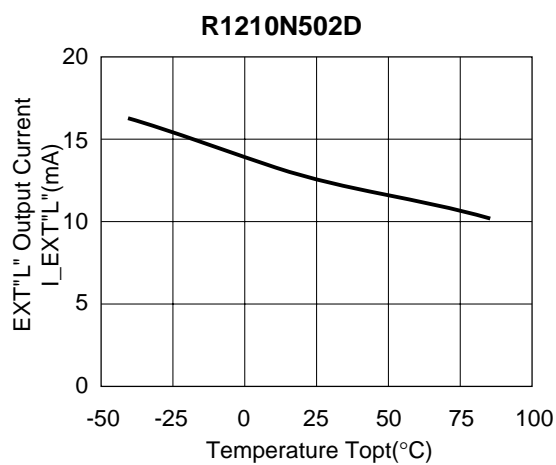
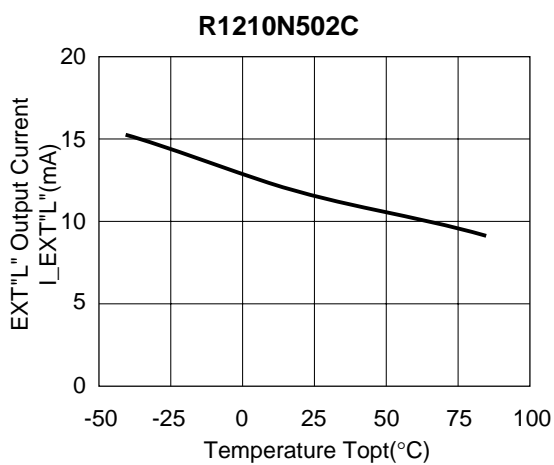
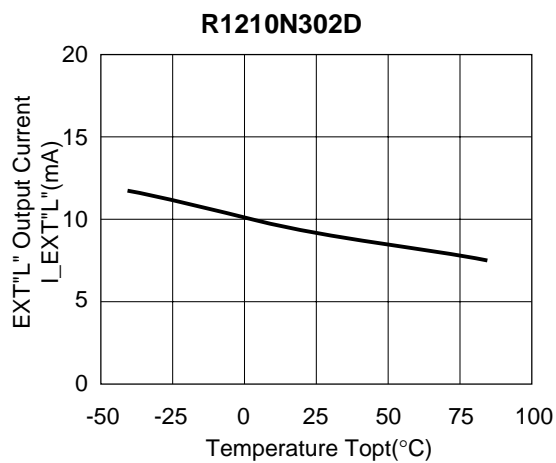
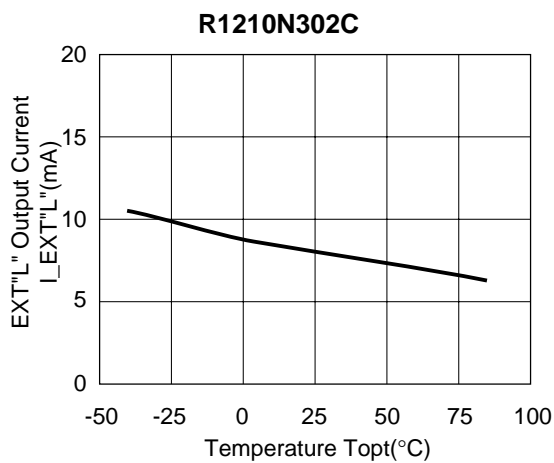



13) CE "H" Input Voltage vs. Temperature

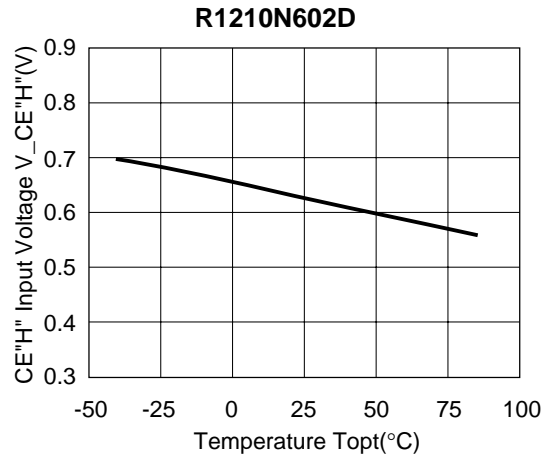
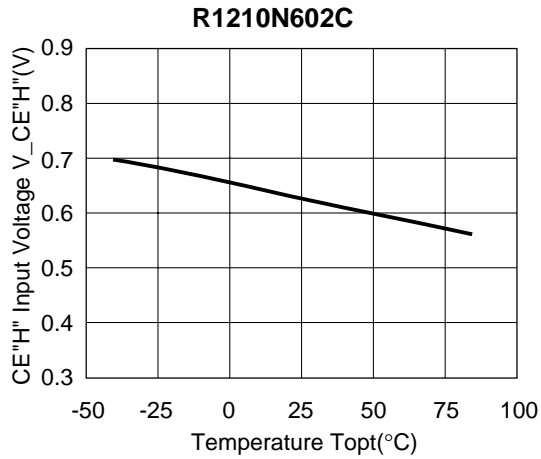

14) CE "L" Input Voltage vs. Temperature

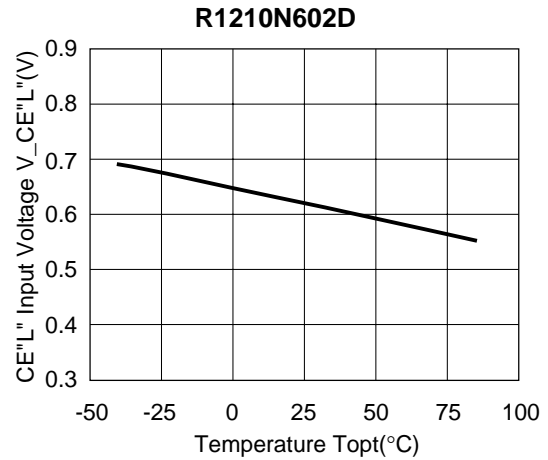
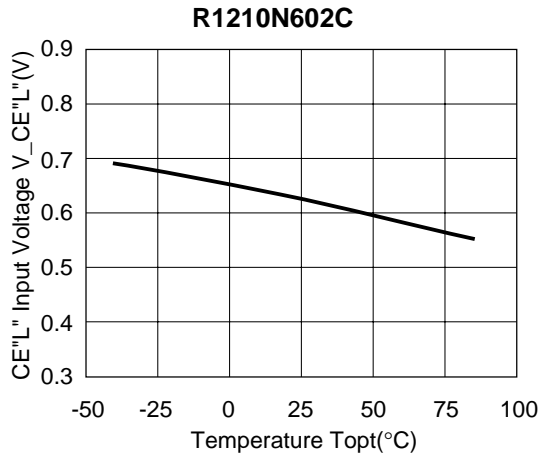

15) Output Waveform at Power-on (T<sub>opt</sub>: 25°C)

((R1210N502C)) (V<sub>IN</sub>: 0[V]→3.0[V])

I<sub>OUT</sub>: 1[mA]

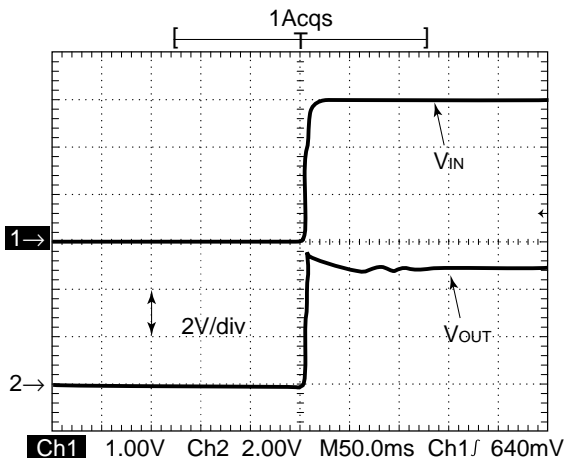

I<sub>OUT</sub>: 100[mA]

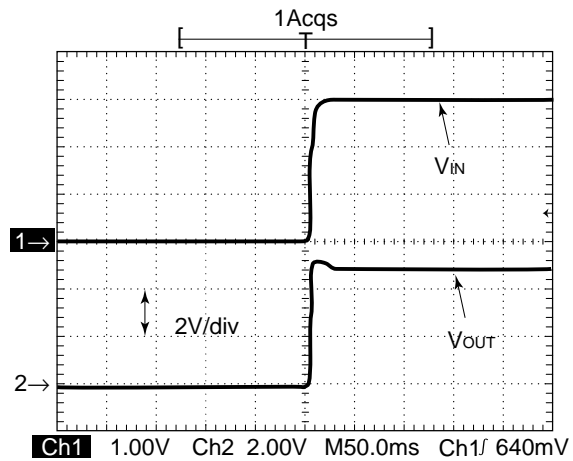

((R1210N502D)) ( $V_{IN}$ : 0[V]→3.0[V])

$I_{OUT}$ : 1[mA]

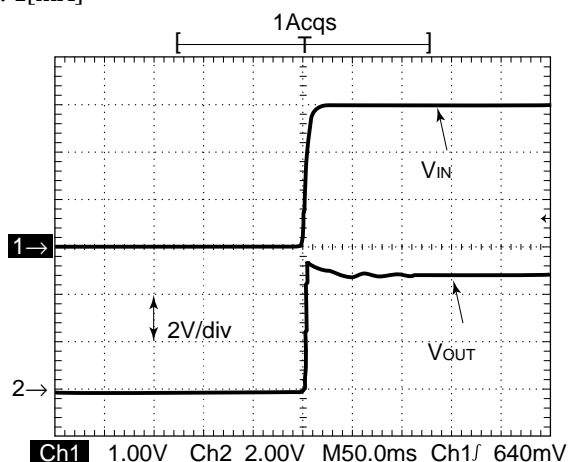

$I_{OUT}$ : 100[mA]

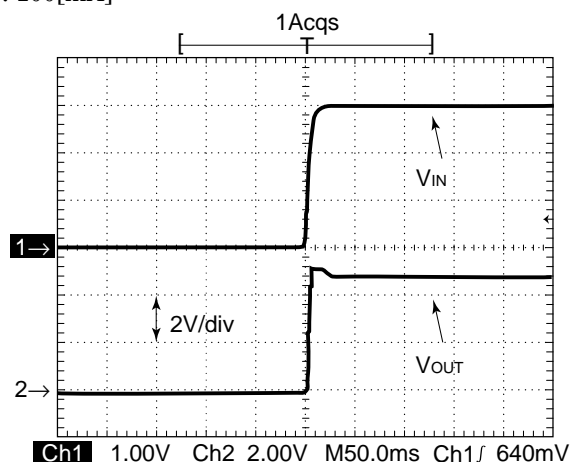

((R1210N302C)) ( $V_{IN}$ : 0[V]→1.5[V])

$I_{OUT}$ : 1[mA]

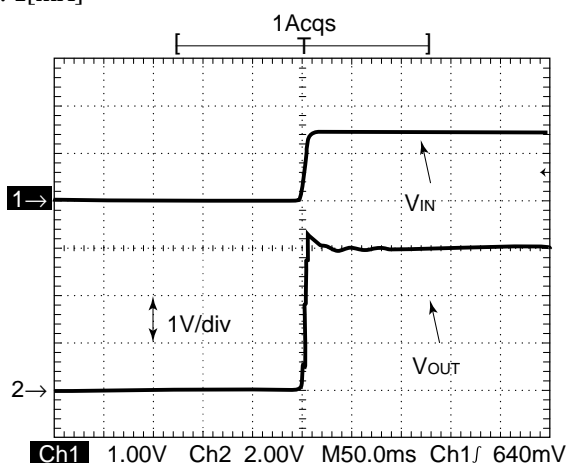

$I_{OUT}$ : 100[mA]

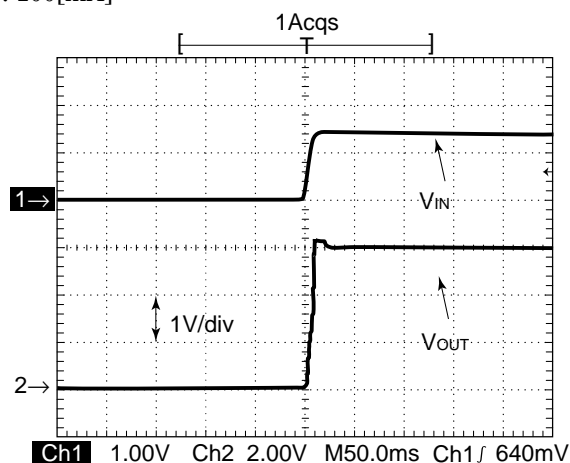

((R1210N302D)) ( $V_{IN}$ : 0[V]→1.5[V])

$I_{OUT}$ : 1[mA]

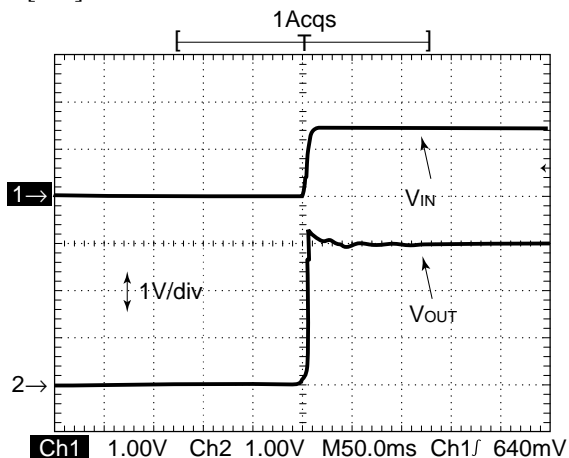

$I_{OUT}$ : 100[mA]

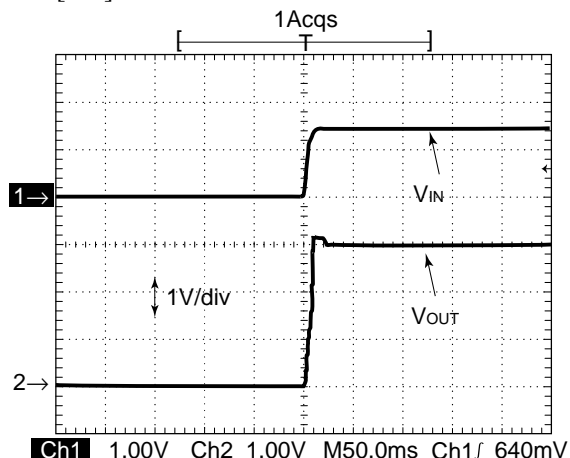

16) Load Transient Response (Topt: 25°C)

((R1210N502C)) ( $V_{IN}$ : 3.0[V],  $I_{OUT}$ : 1[mA]→200[mA])

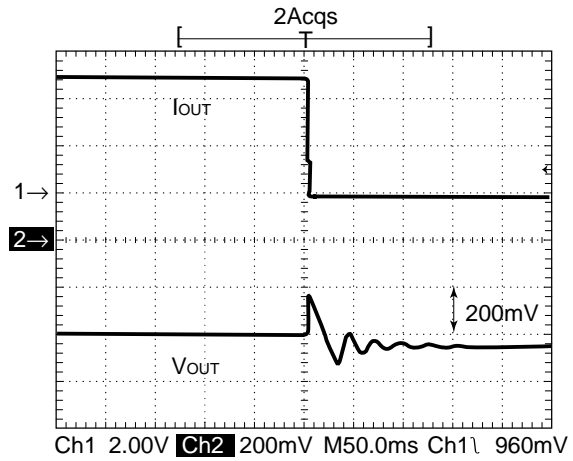
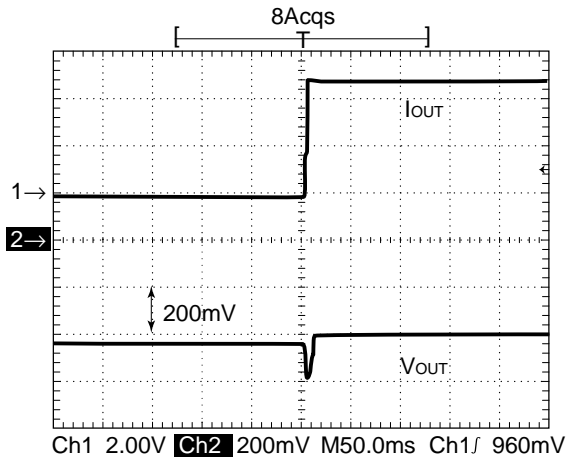

((R1210N502D)) ( $V_{IN}$ : 3.0[V],  $I_{OUT}$ : 1[mA]→200[mA])

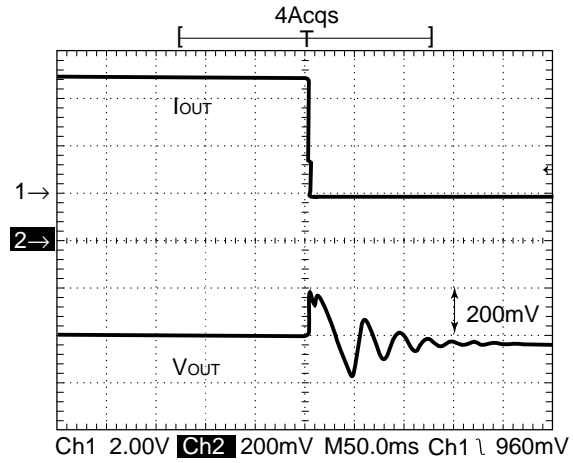
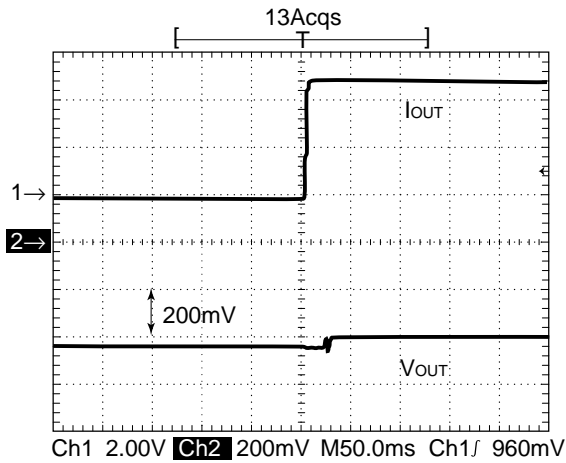

((R1210N302C)) ( $V_{IN}$ : 1.5[V],  $I_{OUT}$ : 1[mA]→100[mA])

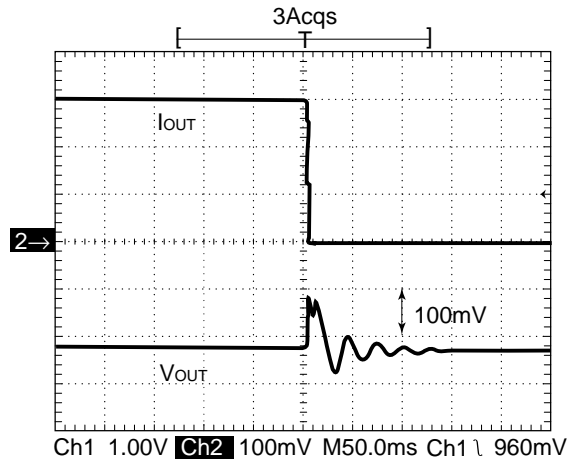
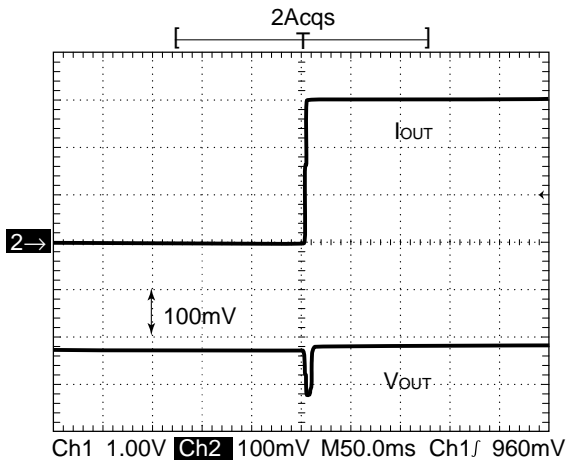

((R1210N302D)) ( $V_{IN}$ : 1.5[V],  $I_{OUT}$ : 1[mA]→100[mA])

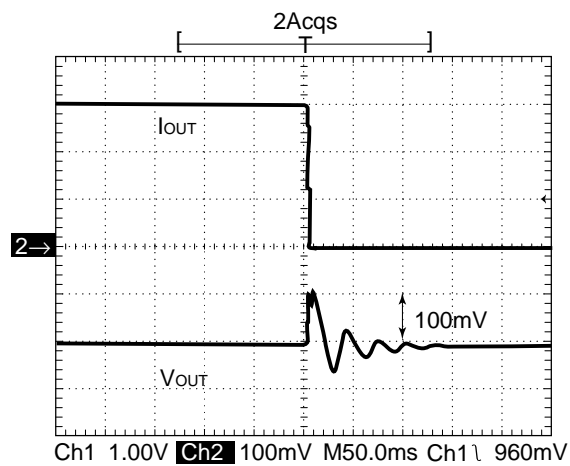
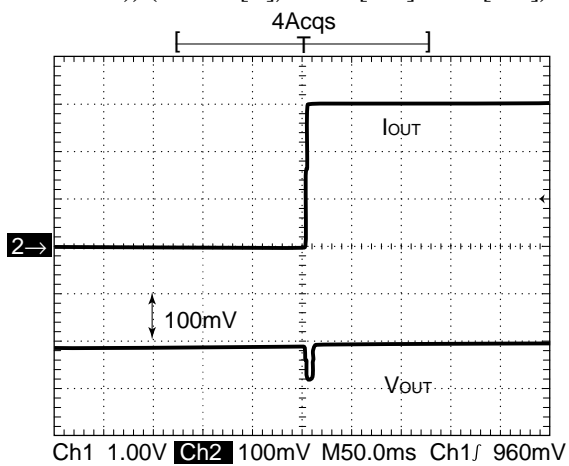

This datasheet has been downloaded from:

[www.DatasheetCatalog.com](http://www.DatasheetCatalog.com)

Datasheets for electronic components.