

PTF 10137

12 Watts, 1.0 GHz

GOLDMOS™ Field Effect Transistor

Description

The PTF 10137 is a 12 Watt LDMOS FET intended for large signal amplifier applications to 1.0 GHz. It operates at 60% efficiency with 18 dB of gain. Nitride surface passivation and full gold metallization ensure excellent device lifetime and reliability.

- Performance at 960 MHz, 28 Volts
 - Output Power = 12 Watts
 - Efficiency = 60% Typ
 - Power Gain = 18 dB Typ
- Full Gold Metallization
- Silicon Nitride Passivated
- Surface Mountable
- Available in Tape and Reel
- 100% Lot Traceability

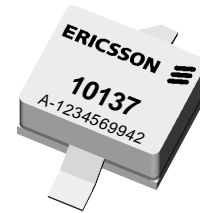
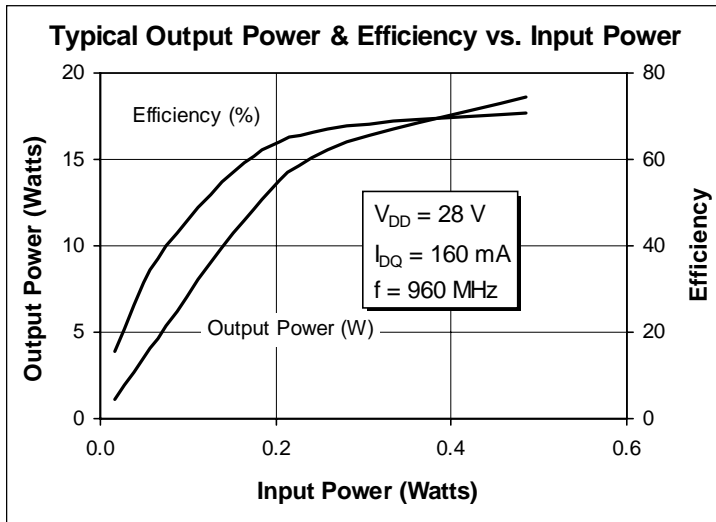

Package 20244

RF Specifications (100% Tested)

Characteristic	Symbol	Min	Typ	Max	Units
Common Source Power Gain ($V_{DD} = 28\text{ V}$, $P_{OUT} = 12\text{ W}$, $I_{DQ} = 160\text{ mA}$, $f = 960\text{ MHz}$)	G_{ps}	16.5	18	—	dB
Power Output at 1 dB Compressed ($V_{DD} = 28\text{ V}$, $I_{DQ} = 160\text{ mA}$, $f = 960\text{ MHz}$)	P-1dB	12	15	—	Watts
Drain Efficiency ($V_{DD} = 28\text{ V}$, $P_{OUT} = 12\text{ W}$, $I_{DQ} = 160\text{ mA}$, $f = 960\text{ MHz}$)	η	55	60	—	%
Load Mismatch Tolerance ($V_{DD} = 28\text{ V}$, $P_{OUT} = 12\text{ W}$, $I_{DQ} = 160\text{ mA}$, $f = 960\text{ MHz}$) —all phase angles at frequency of test)	Ψ	—	—	10:1	—

All published data at $T_{CASE} = 25^\circ\text{C}$ unless otherwise indicated.

Electrical Characteristics (100% Tested)

Characteristic	Conditions	Symbol	Min	Typ	Max	Units
Drain-Source Breakdown Voltage	$V_{GS} = 0\text{ V}, I_D = 25\text{ mA}$	$V_{(BR)DSS}$	65	—	—	Volts
Drain-Source Leakage Current	$V_{DS} = 28\text{ V}, V_{GS} = 0\text{ V}$	I_{DSS}	—	—	1	mA
Gate Threshold Voltage	$V_{DS} = 10\text{ V}, I_D = 75\text{ mA}$	$V_{GS(th)}$	3.0	—	5.0	Volts
Forward Transconductance	$V_{DS} = 10\text{ V}, I_D = 0.5\text{ A}$	g_{fs}	—	0.9	—	Siemens

Maximum Ratings

Parameter	Symbol	Value	Unit
Drain-Source Voltage	V_{DSS}	65	Vdc
Gate-Source Voltage	V_{GS}	± 20	Vdc
Operating Junction Temperature	T_J	200	$^{\circ}\text{C}$
Total Device Dissipation Above 25°C derate by	P_D	58 0.33	Watts $\text{W}/^{\circ}\text{C}$
Storage Temperature Range	T_{STG}	-40 to 150	$^{\circ}\text{C}$
Thermal Resistance ($T_{CASE} = 70^{\circ}\text{C}$)	$R_{\theta JC}$	3.0	$^{\circ}\text{C}/\text{W}$

Typical Performance

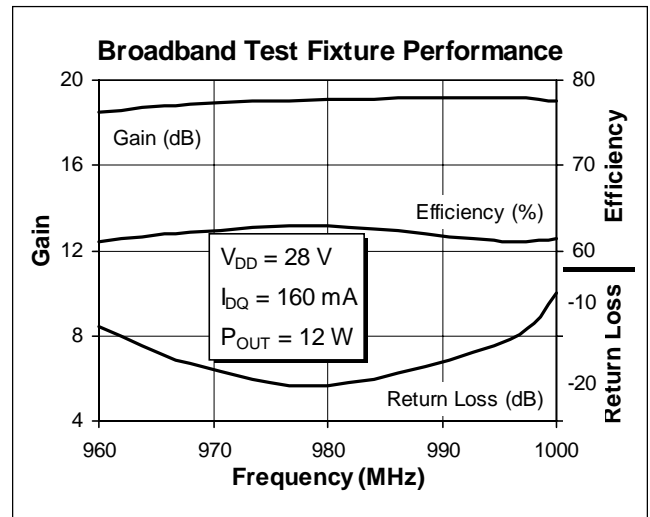
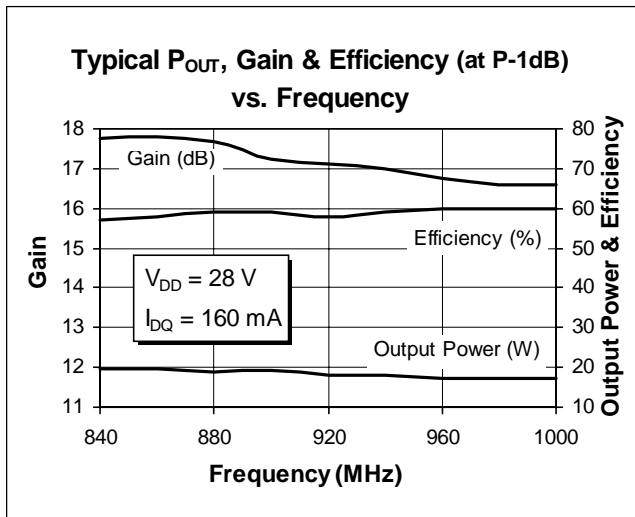

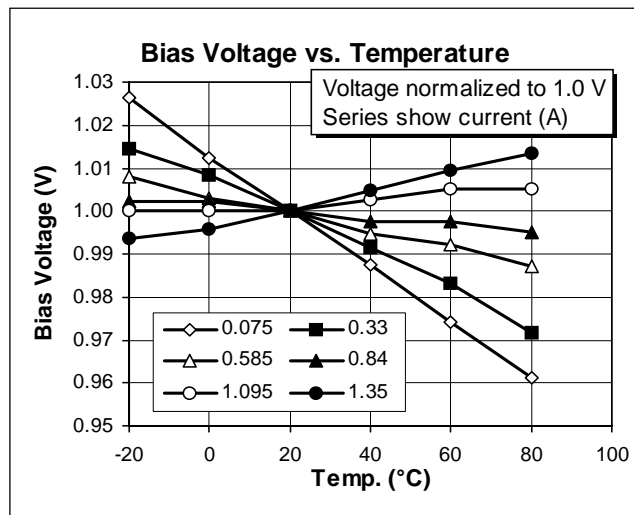
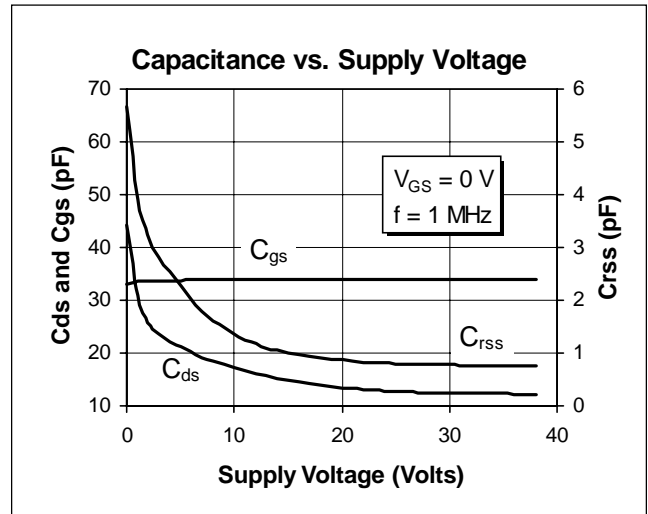
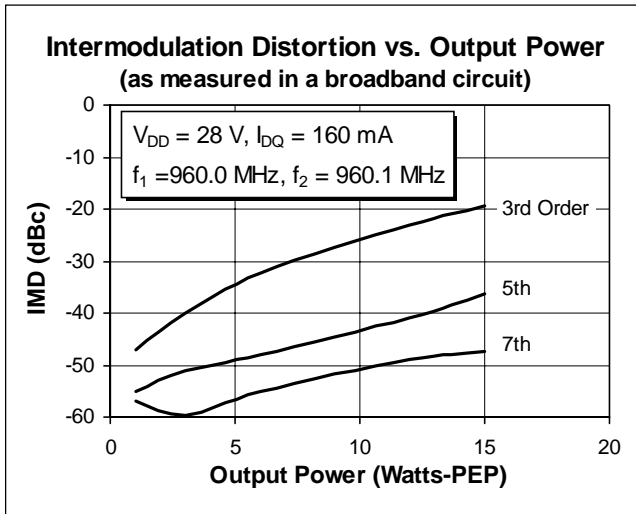
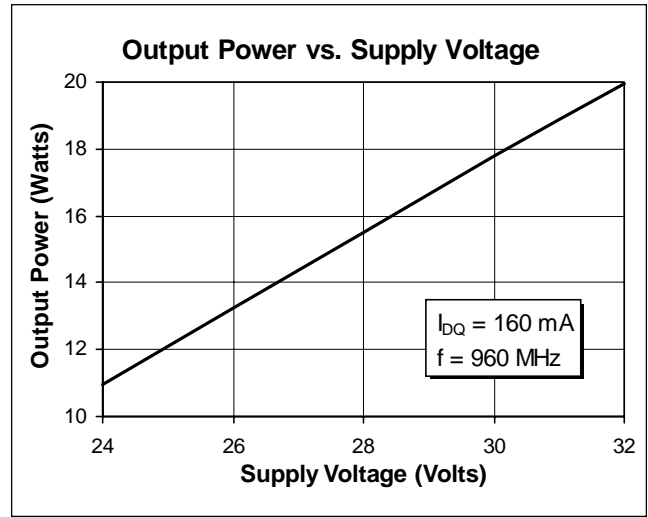
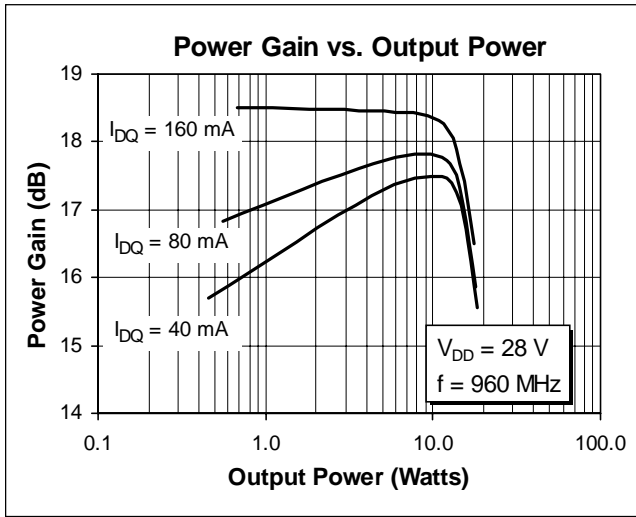

PTF 10137



Impedance Data

$V_{DD} = 28\text{ V}$, $I_{DQ} = 160\text{ mA}$, $P_{-1\text{dB}} = 18\text{ W}$

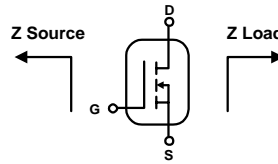

Frequency MHz	Z Source Ω		Z Load Ω	
	R	jX	R	jX
840	1.1	1.9	4.1	4.3
860	0.8	0.8	3.8	3.3
880	0.8	0.1	3.7	2.8
900	0.7	-0.3	3.6	2.3
920	0.6	-0.7	4.1	2.1
940	0.8	-0.9	4.3	2.0
960	1.1	-1.2	4.8	1.6
980	1.6	-1.2	5.3	2.6
1000	1.6	-0.9	5.0	3.7

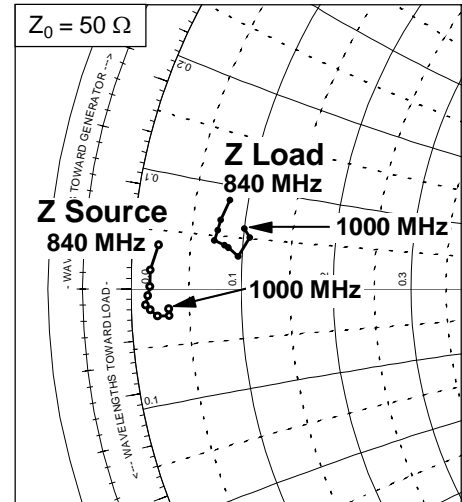

Typical Scattering Parameters

$(V_{DS} = 28\text{ V}, I_D = 450\text{ mA})$

f (MHz)	S11		S21		S12		S22	
	Mag	Ang	Mag	Ang	Mag	Ang	Mag	Ang
100	0.862	-126	25.8	101	0.018	11.5	0.575	-78.7
150	0.866	-135	21.1	93.6	0.018	3.96	0.583	-86.4
200	0.872	-146	15.5	80.9	0.018	-5.92	0.587	-97.4
250	0.881	-153	12.0	71.6	0.017	-13.4	0.613	-106
300	0.888	-157	9.57	63.7	0.016	-19.1	0.646	-113
350	0.896	-161	7.86	57.0	0.015	-24.0	0.679	-119
400	0.905	-164	6.55	51.0	0.013	-27.9	0.713	-124
450	0.910	-166	5.53	45.7	0.012	-31.0	0.742	-129
500	0.920	-168	4.74	40.8	0.011	-32.8	0.770	-133
550	0.927	-169	4.09	36.6	0.009	-34.0	0.792	-137
600	0.932	-171	3.57	32.4	0.008	-35.0	0.813	-141
650	0.940	-173	3.15	28.9	0.007	-34.2	0.834	-144
700	0.942	-174	2.79	25.5	0.006	-32.7	0.849	-147
750	0.948	-175	2.49	22.1	0.005	-27.9	0.865	-150
800	0.953	-177	2.23	19.3	0.004	-20.5	0.874	-152
850	0.955	-178	2.01	16.2	0.003	-8.60	0.884	-155
900	0.958	-179	1.83	13.6	0.003	10.9	0.896	-157
950	0.961	-180	1.66	11.1	0.003	32.3	0.902	-159
1000	0.963	179	1.52	8.52	0.003	47.7	0.912	-161
1050	0.967	178	1.39	6.44	0.004	57.8	0.917	-162
1100	0.967	177	1.27	4.07	0.004	63.1	0.921	-164
1150	0.967	176	1.18	1.96	0.005	68.8	0.929	-166
1200	0.970	175	1.09	0.12	0.006	70.7	0.932	-167
1250	0.970	174	1.01	-2.03	0.006	73.2	0.937	-169
1300	0.972	173	0.943	-3.66	0.007	74.5	0.943	-170
1350	0.973	172	0.874	-5.57	0.008	75.7	0.943	-172
1400	0.978	172	0.825	-7.37	0.009	75.8	0.950	-173
1450	0.978	171	0.772	-8.77	0.009	76.4	0.948	-174
1500	0.981	170	0.729	-10.7	0.010	76.6	0.952	-176
1550	0.981	169	0.689	-12.1	0.011	77.2	0.958	-177
1600	0.982	168	0.647	-13.9	0.012	76.3	0.958	-178
1650	0.983	167	0.615	-15.7	0.013	75.0	0.966	-179
1700	0.983	167	0.580	-16.9	0.013	74.7	0.964	-180
1750	0.983	166	0.549	-18.7	0.014	74.4	0.961	179
1800	0.983	165	0.525	-20.3	0.015	74.7	0.962	178
1850	0.981	164	0.499	-21.8	0.015	74.0	0.958	176
1900	0.981	163	0.478	-23.4	0.016	72.9	0.967	175
1950	0.981	162	0.454	-24.3	0.017	72.1	0.967	175
2000	0.981	161	0.431	-26.0	0.018	71.3	0.967	173
2050	0.981	161	0.414	-27.3	0.018	71.3	0.969	173
2100	0.979	160	0.395	-28.6	0.019	70.8	0.963	172
2150	0.979	159	0.382	-30.0	0.019	69.8	0.969	170
2200	0.975	158	0.371	-30.7	0.020	69.1	0.969	169

Test Circuit

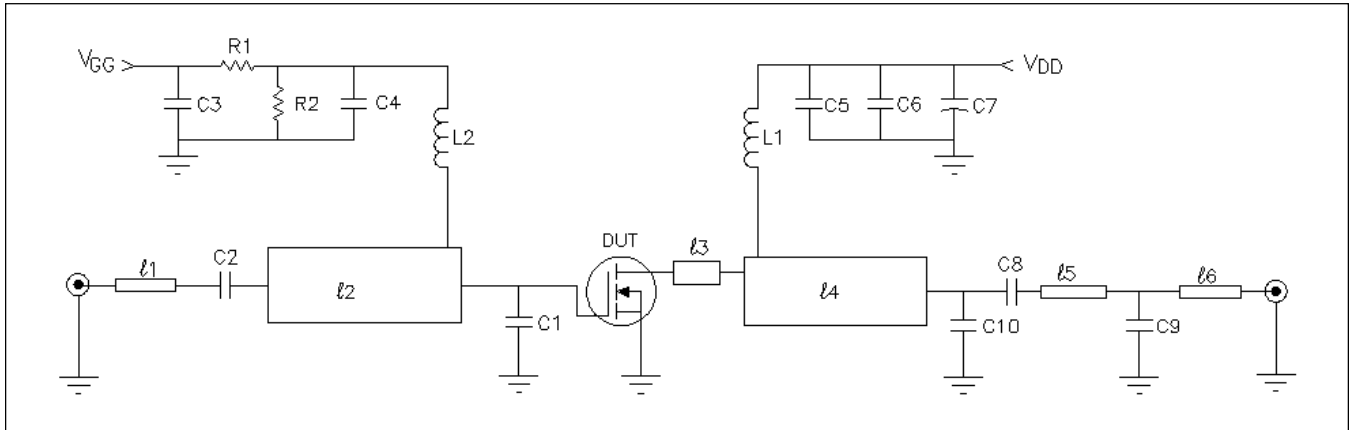

Test Circuit Schematic for $f = 960$ MHz

DUT	PTF 10137		C1	ATC 100 B	Capacitor, 8.2 pF, ATC 100 B
$l1, l6$		Microstrip 50 Ω	C2,C4,C5,C8	ATC 100 B	Capacitor, 36 pF, ATC 100 B
$l2$	0.197λ 960 MHz	Microstrip 10 Ω	C3,C6	Digi-Key P4525-ND	Capacitor, 0.1 μ F, 50V
$l3$	0.018λ 960 MHz	Microstrip 44 Ω	C7	Digi-Key P5182-ND	Capacitor, 100 μ F, 50V
$l4$	0.184λ 960 MHz	Microstrip 12.7 Ω	C9, C10	ATC 100 B	2.0 pF Capacitor, ATC 100 B
$l5$	0.047λ 960 MHz	Microstrip 50 Ω	R1, R2	Digi-Key 2.2 QBK	Resistor, 220 Ω , 1/4W
			L1,L2	N/A	4 Turn, 20 AWG, .120 I.D.
			Circuit Board	.028" Dielectric Thickness, $\epsilon_r = 4.0$, AlliedSignal, G200, 2 oz. copper	

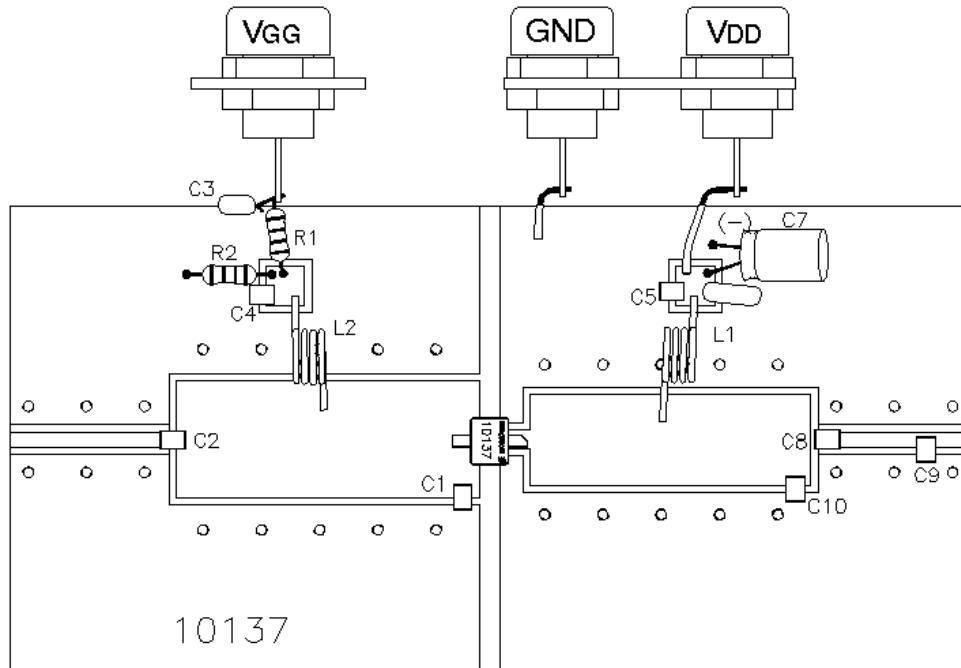

Assembly Diagram (not to scale)

Test Circuit

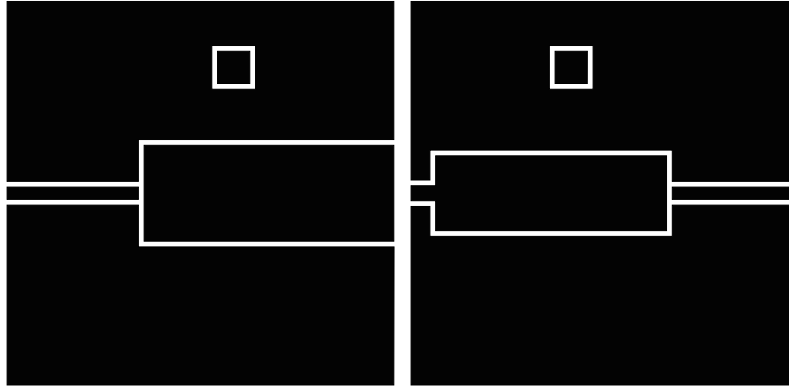

Artwork (1 inch )

This datasheet has been download from:

www.datasheetcatalog.com

Datasheets for electronics components.