

Thyristor Modules

$I_{TRMS} = 2x 40 A$
 $I_{TAVM} = 2x 25 A$
 $V_{RRM} = 800-1600 V$

V_{RSM}	V_{RRM}	Type	
V_{DSM}	V_{DRM}	Version 1 B	Version 8 B
V	V		
900	800	MCC 19-08io1 B	MCC 19-08io8 B
1300	1200	MCC 19-12io1 B	MCC 19-12io8 B
1500	1400	MCC 19-14io1 B	MCC 19-14io8 B
1700	1600	MCC 19-16io1 B	MCC 19-16io8 B

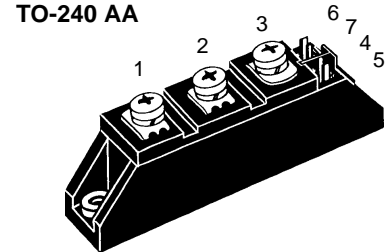

Symbol	Test Conditions	Maximum Ratings		
I_{TRMS}	$T_{VJ} = T_{VJM}$	40	A	
	$T_C = 58^{\circ}C$; 180° sine	25	A	
	$T_C = 85^{\circ}C$; 180° sine	18	A	
I_{TSM}	$T_{VJ} = 45^{\circ}C$; $V_R = 0$	$t = 10 ms$ (50 Hz), sine	400	A
		$t = 8.3 ms$ (60 Hz), sine	420	A
	$T_{VJ} = T_{VJM}$; $V_R = 0$	$t = 10 ms$ (50 Hz), sine	350	A
		$t = 8.3 ms$ (60 Hz), sine	370	A
$\int i^2 dt$	$T_{VJ} = 45^{\circ}C$; $V_R = 0$	$t = 10 ms$ (50 Hz), sine	800	A ² s
		$t = 8.3 ms$ (60 Hz), sine	730	A ² s
	$T_{VJ} = T_{VJM}$; $V_R = 0$	$t = 10 ms$ (50 Hz), sine	600	A ² s
		$t = 8.3 ms$ (60 Hz), sine	570	A ² s
$(di/dt)_{cr}$	$T_{VJ} = T_{VJM}$; $f = 50 Hz$, $t_p = 200 \mu s$; $V_D = 2/3 V_{DRM}$; $I_G = 0.45 A$; $di_G/dt = 0.45 A/\mu s$	repetitive, $I_T = 45 A$	150	A/ μs
		non repetitive, $I_T = I_{TAVM}$	500	A/ μs
	$T_{VJ} = T_{VJM}$; $R_{GK} = \infty$; method 1 (linear voltage rise)	$V_{DR} = 2/3 V_{DRM}$	1000	V/ μs
P_{GM}	$T_{VJ} = T_{VJM}$; $I_T = I_{TAVM}$	$t_p = 30 \mu s$	10	W
		$t_p = 300 \mu s$	5	W
P_{GAV}			0.5	W
V_{RGM}			10	V
T_{VJ}			-40...+125	°C
T_{VJM}			125	°C
T_{stg}			-40...+125	°C
V_{ISOL}	50/60 Hz, RMS $I_{ISOL} \leq 1 mA$	$t = 1 min$	3000	V~
		$t = 1 s$	3600	V~
M_d	Mounting torque (M5)		2.5-4.0/22-35	Nm/lb.in.
	Terminal connection torque (M5)		2.5-4.0/22-35	Nm/lb.in.
Weight	Typical including screws		90	g

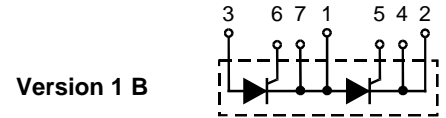
Version 1 B
Version 8 B
Features

- International standard package, JEDEC TO-240 AA
- Direct copper bonded Al₂O₃ -ceramic base plate
- Planar passivated chips
- Isolation voltage 3600 V~
- UL registered, E 72873
- Gate-cathode twin pins for version 1B

Applications

- DC motor control
- Softstart AC motor controller
- Light, heat and temperature control

Advantages

- Space and weight savings
- Simple mounting with two screws
- Improved temperature and power cycling
- Reduced protection circuits

Data according to IEC 60747 and refer to a single thyristor unless otherwise stated. IXYS reserves the right to change limits, test conditions and dimensions

Symbol	Test Conditions	Characteristic Values
I_{RRM}, I_{DRM}	$T_{VJ} = T_{VJM}; V_R = V_{RRM}; V_D = V_{DRM}$	3 mA
V_T	$I_T = 80 \text{ A}; T_{VJ} = 25^\circ\text{C}$	2.05 V
V_{T0}	For power-loss calculations only ($T_{VJ} = 125^\circ\text{C}$)	0.85 V
r_T		18 mΩ
V_{GT}	$V_D = 6 \text{ V}; T_{VJ} = 25^\circ\text{C}$	1.5 V
I_{GT}	$V_D = 6 \text{ V}; T_{VJ} = -40^\circ\text{C}$	1.6 V
V_{GD}	$T_{VJ} = T_{VJM}; V_D = 2/3 V_{DRM}$	0.2 V
I_{GD}		10 mA
I_L	$T_{VJ} = 25^\circ\text{C}; t_p = 10 \mu\text{s}; V_D = 6 \text{ V}$ $I_G = 0.45 \text{ A}; di_G/dt = 0.45 \text{ A}/\mu\text{s}$	450 mA
I_H	$T_{VJ} = 25^\circ\text{C}; V_D = 6 \text{ V}; R_{GK} = \infty$	200 mA
t_{gd}	$T_{VJ} = 25^\circ\text{C}; V_D = 1/2 V_{DRM}$ $I_G = 0.45 \text{ A}; di_G/dt = 0.45 \text{ A}/\mu\text{s}$	2 μs
t_q	$T_{VJ} = T_{VJM}; I_T = 20 \text{ A}, t_p = 200 \mu\text{s}; -di/dt = 10 \text{ A}/\mu\text{s}$ typ. $V_R = 100 \text{ V}; dv/dt = 20 \text{ V}/\mu\text{s}; V_D = 2/3 V_{DRM}$	150 μs
Q_S	$T_{VJ} = T_{VJM}; I_T = 25 \text{ A}, -di/dt = 0.64 \text{ A}/\mu\text{s}$	50 μC
I_{RM}		6 A
R_{thJC}	per thyristor; DC current per module	1.3 K/W
R_{thJK}	per thyristor; DC current per module	0.65 K/W
	other values see Fig. 8/9	1.5 K/W
		0.75 K/W
d_s	Creepage distance on surface	12.7 mm
d_A	Strike distance through air	9.6 mm
a	Maximum allowable acceleration	50 m/s ²

Optional accessories for module-type MCC 19 version 1 B

Keyed gate/cathode twin plugs with wire length = 350 mm, gate = yellow, cathode = red

Type ZY 200L (L = Left for pin pair 4/5) } UL 758, style 1385,

Type ZY 200R (R = right for pin pair 6/7) } CSA class 5851, guide 460-1-1

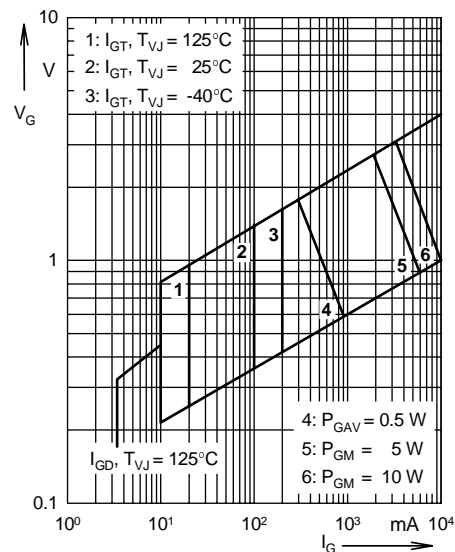

Fig. 1 Gate trigger characteristics

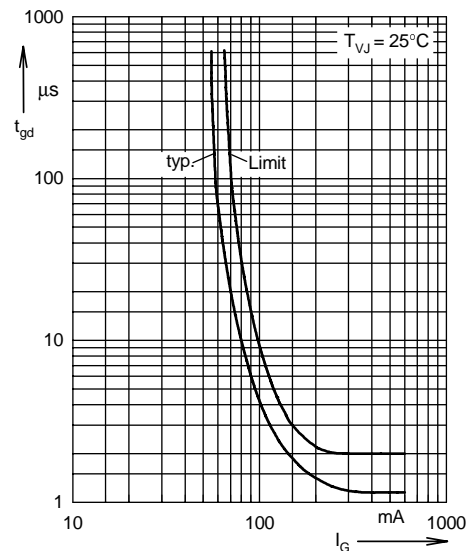
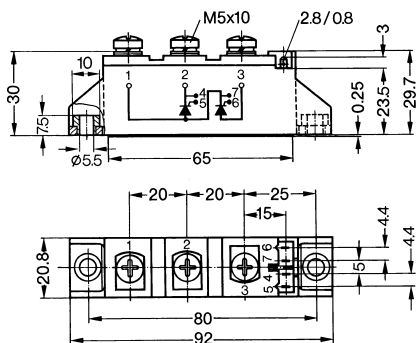

Fig. 2 Gate trigger delay time

Dimensions in mm (1 mm = 0.0394")

Version 1 B



Version 8 B

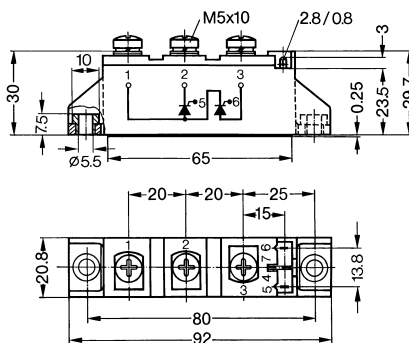

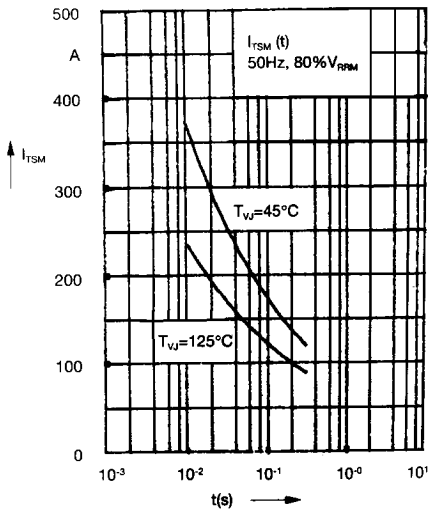

Fig. 3 Surge overload current
 I_{TSM} : Crest value, t : duration

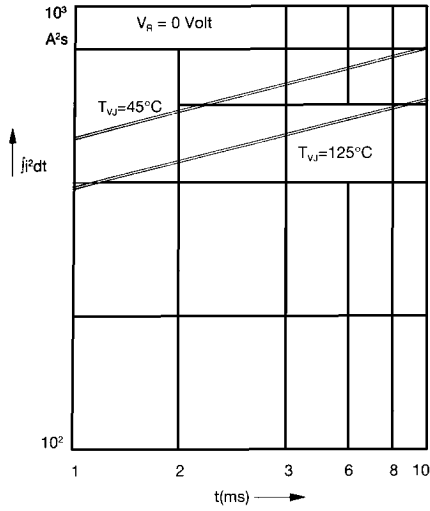

Fig. 4 $\int i^2 dt$ versus time (1-10 ms)

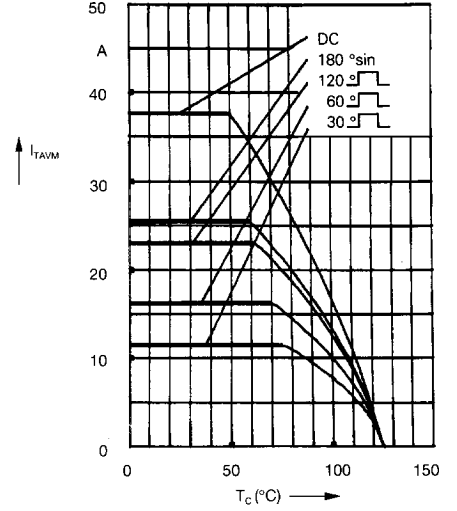

Fig. 4a Maximum forward current at case temperature

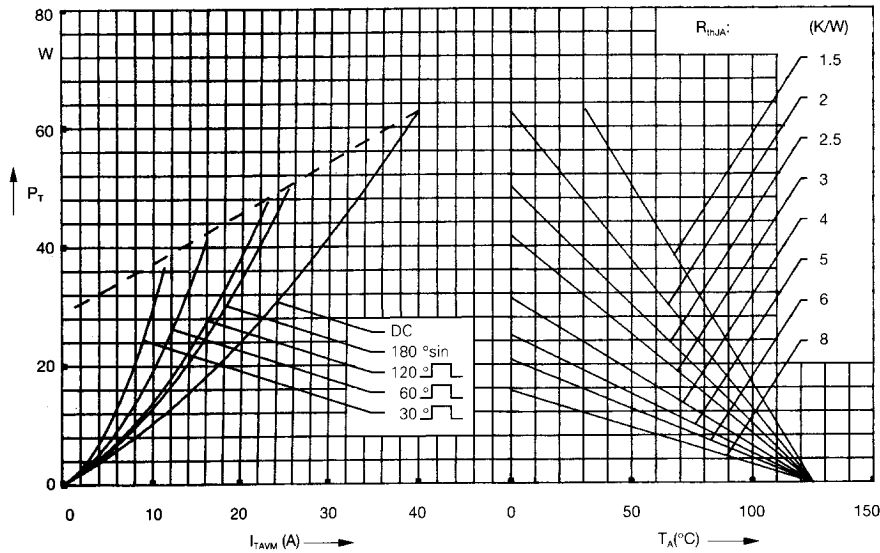

Fig. 5 Power dissipation versus on-state current and ambient temperature (per thyristor)

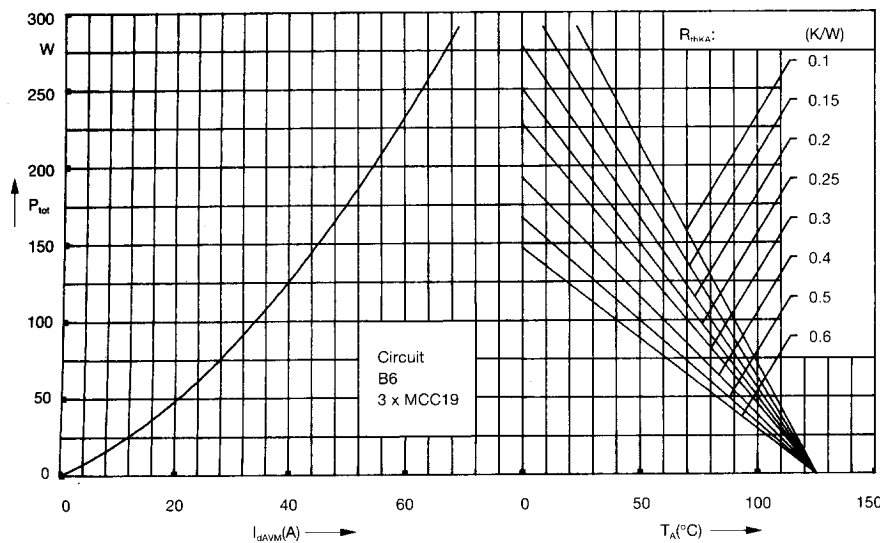

Fig. 6 Three phase rectifier bridge: Power dissipation versus direct output current and ambient temperature

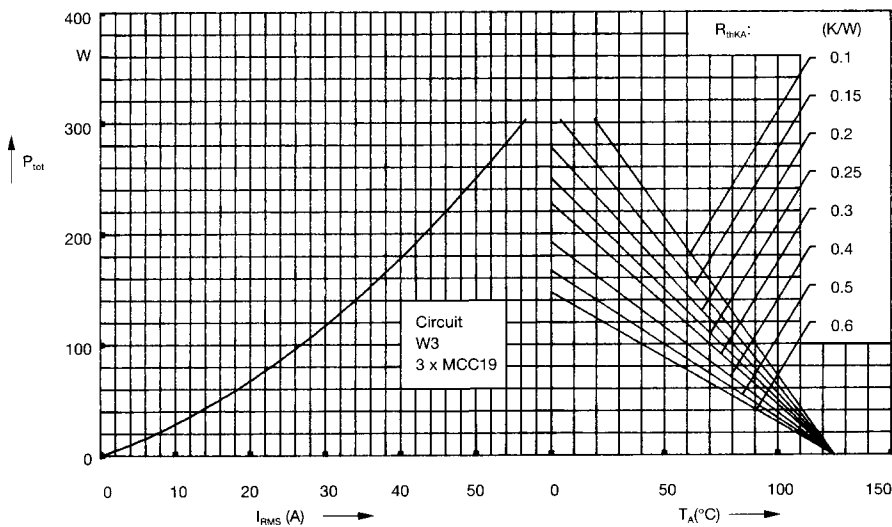

Fig. 7 Three phase AC-controller: Power dissipation versus RMS output current and ambient temperature

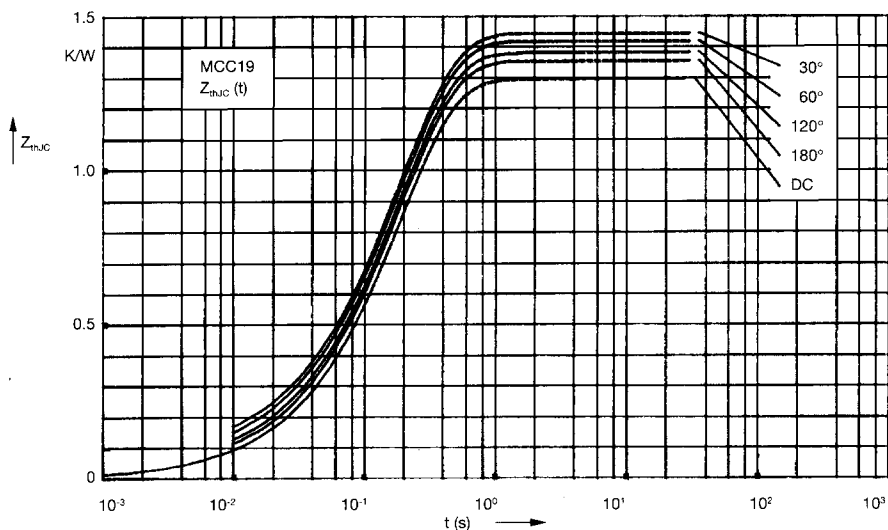

Fig. 8 Transient thermal impedance junction to case (per thyristor)

R_{thJC} for various conduction angles d:

d	R_{thJC} (K/W)
DC	1.3
180°	1.35
120°	1.39
60°	1.42
30°	1.45

Constants for Z_{thJC} calculation:

i	R_{thi} (K/W)	t_i (s)
1	0.018	0.0033
2	0.041	0.0216
3	1.241	0.191

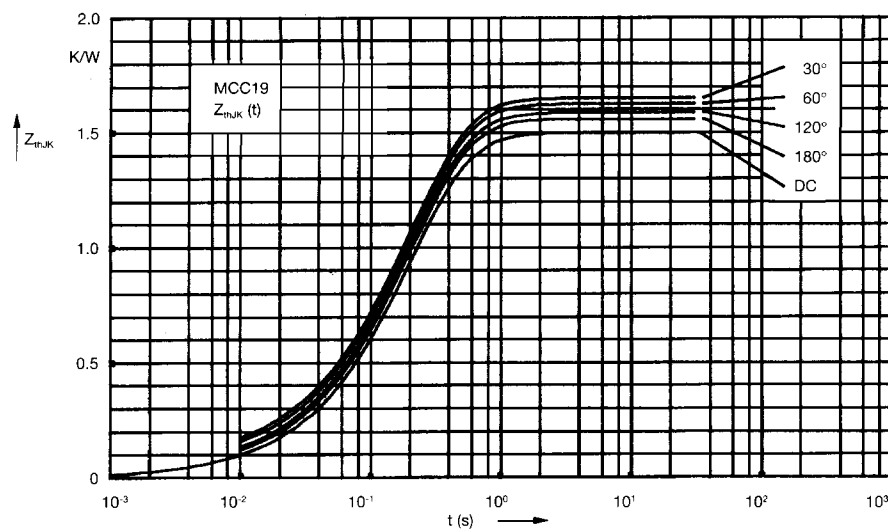

Fig. 9 Transient thermal impedance junction to heatsink (per thyristor)

R_{thJK} for various conduction angles d:

d	R_{thJK} (K/W)
DC	1.5
180°	1.55
120°	1.59
60°	1.62
30°	1.65

Constants for Z_{thJK} calculation:

i	R_{thi} (K/W)	t_i (s)
1	0.018	0.0033
2	0.041	0.0216
3	1.241	0.191
4	0.2	0.46

This datasheet has been download from:

www.datasheetcatalog.com

Datasheets for electronics components.