

# MC34164 MC33164

## Micropower Undervoltage Sensing Circuits

The MC34164 series are undervoltage sensing circuits specifically designed for use as reset controllers in portable microprocessor based systems where extended battery life is required. These devices offer the designer an economical solution for low voltage detection with a single external resistor. The MC34164 series features a bandgap reference, a comparator with precise thresholds and built-in hysteresis to prevent erratic reset operation, an open collector reset output capable of sinking in excess of 6.0 mA, and guaranteed operation down to 1.0 V input with extremely low standby current. These devices are packaged in 3-pin TO-226AA, 8-pin SO-8 and Micro-8 surface mount packages.

Applications include direct monitoring of the 3.0 or 5.0 V MPU/logic power supply used in appliance, automotive, consumer, and industrial equipment.

- Temperature Compensated Reference
- Monitors 3.0 V (MC34164-3) or 5.0 V (MC34164-5) Power Supplies
- Precise Comparator Thresholds Guaranteed Over Temperature
- Comparator Hysteresis Prevents Erratic Reset
- Reset Output Capable of Sinking in Excess of 6.0 mA
- Internal Clamp Diode for Discharging Delay Capacitor
- Guaranteed Reset Operation With 1.0 V Input
- Extremely Low Standby Current: As Low as 9.0  $\mu$ A
- Economical TO-226AA, SO-8 and Micro-8 Surface Mount Packages

### MICROPOWER UNDERTVOLTAGE SENSING CIRCUITS

#### SEMICONDUCTOR TECHNICAL DATA

**P SUFFIX**  
PLASTIC PACKAGE  
CASE 29  
(TO-226AA)

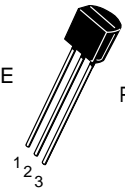

Pin 1. Reset  
2. Input  
3. Ground

**D SUFFIX**  
PLASTIC PACKAGE  
CASE 751  
(SO-8)

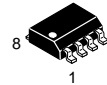

**DM SUFFIX**  
PLASTIC PACKAGE  
CASE 846A  
(Micro-8)

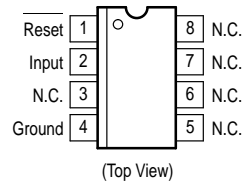

### Representative Block Diagram

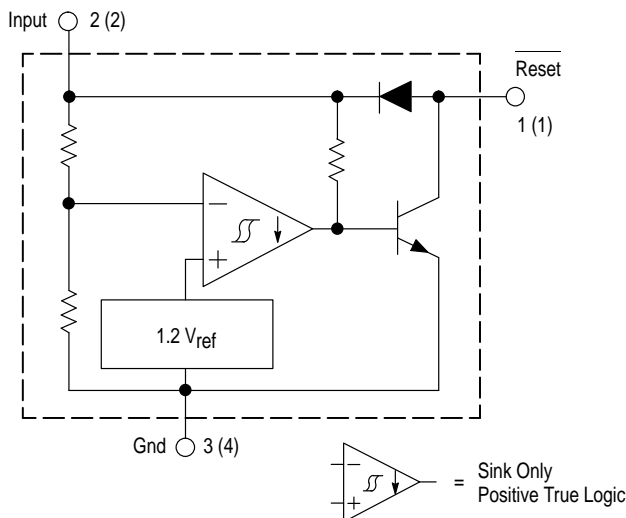

Pin numbers adjacent to terminals are for the 3-pin TO-226AA package.  
Pin numbers in parenthesis are for the 8-lead packages.

This device contains 28 active transistors.

### ORDERING INFORMATION

Device	Operating Temperature Range	Package
MC34164D-3	$T_A = 0^\circ \text{ to } +70^\circ \text{C}$	SO-8
MC34164D-5		
MC34164DM-3		Micro-8
MC34164DM-5		
MC34164P-3		
MC34164P-5	TO-226AA	
MC33164D-3	$T_A = -40^\circ \text{ to } +125^\circ \text{C}$	SO-8
MC33164D-5		
MC33164DM-3		Micro-8
MC33164DM-5		
MC33164P-3		
MC33164P-5		TO-226AA

# MC34164 MC33164

## MAXIMUM RATINGS

Rating	Symbol	Value	Unit
Power Input Supply Voltage	$V_{in}$	-1.0 to 12	V
Reset Output Voltage	$V_O$	-1.0 to 12	V
Reset Output Sink Current	$I_{Sink}$	Internally Limited	mA
Clamp Diode Forward Current, Pin 1 to 2 (Note 1)	$I_F$	100	mA
Power Dissipation and Thermal Characteristics			
P Suffix, Plastic Package			
Maximum Power Dissipation @ $T_A = 25^\circ\text{C}$	$P_D$	700	mW
Thermal Resistance, Junction-to-Air	$R_{\theta JA}$	178	$^\circ\text{C/W}$
D Suffix, Plastic Package			
Maximum Power Dissipation @ $T_A = 25^\circ\text{C}$	$P_D$	700	mW
Thermal Resistance, Junction-to-Air	$R_{\theta JA}$	178	$^\circ\text{C/W}$
DM Suffix, Plastic Package			
Maximum Power Dissipation @ $T_A = 25^\circ\text{C}$	$P_D$	520	mW
Thermal Resistance, Junction-to-Air	$R_{\theta JA}$	240	$^\circ\text{C/W}$
Operating Junction Temperature	$T_J$	+150	$^\circ\text{C}$
Operating Ambient Temperature Range	$T_A$		$^\circ\text{C}$
MC34164 Series		0 to +70	
MC33164 Series		-40 to +85	
Storage Temperature Range	$T_{stg}$	-65 to +150	$^\circ\text{C}$

NOTE: ESD data available upon request.

## MC34164-3, MC33164-3 SERIES

**ELECTRICAL CHARACTERISTICS** (For typical values  $T_A = 25^\circ\text{C}$ , for min/max values  $T_A$  is the operating ambient temperature range that applies [Notes 2 & 3], unless otherwise noted.)

Characteristic	Symbol	Min	Typ	Max	Unit
<b>COMPARATOR</b>					
Threshold Voltage					V
High State Output ( $V_{in}$ Increasing)	$V_{IH}$	2.55	2.71	2.80	
Low State Output ( $V_{in}$ Decreasing)	$V_{IL}$	2.55	2.65	2.80	
Hysteresis ( $I_{Sink} = 100 \mu\text{A}$ )	$V_H$	0.03	0.06	-	
<b>RESET OUTPUT</b>					
Output Sink Saturation	$V_{OL}$				V
( $V_{in} = 2.4 \text{ V}$ , $I_{Sink} = 1.0 \text{ mA}$ )		-	0.14	0.4	
( $V_{in} = 1.0 \text{ V}$ , $I_{Sink} = 0.25 \text{ mA}$ )		-	0.1	0.3	
Output Sink Current ( $V_{in}$ , Reset = 2.4 V)	$I_{Sink}$	6.0	12	30	mA
Output Off-State Leakage	$I_R(\text{leak})$				$\mu\text{A}$
( $V_{in}$ , Reset = 3.0 V)		-	0.02	0.5	
( $V_{in}$ , Reset = 10 V)		-	0.02	1.0	
Clamp Diode Forward Voltage, Pin 1 to 2 ( $I_F = 5.0 \text{ mA}$ )	$V_F$	6.0	0.9	1.2	V
<b>TOTAL DEVICE</b>					
Operating Input Voltage Range	$V_{in}$	1.0 to 10	-	-	V
Quiescent Input Current	$I_{in}$				$\mu\text{A}$
$V_{in} = 3.0 \text{ V}$		-	9.0	15	
$V_{in} = 6.0 \text{ V}$		-	24	40	

- NOTES: 1. Maximum package power dissipation limits must be observed.  
 2. Low duty cycle pulse techniques are used during test to maintain junction temperature as close to ambient as possible.  
 3.  $T_{low} = 0^\circ\text{C}$  for MC34164       $T_{high} = +70^\circ\text{C}$  for MC34164  
      $-40^\circ\text{C}$  for MC33164          $= +85^\circ\text{C}$  for MC33164

# MC34164 MC33164

## MC34164–5, MC33164–5 SERIES

**ELECTRICAL CHARACTERISTICS** (For typical values  $T_A = 25^\circ\text{C}$ , for min/max values  $T_A$  is the operating ambient temperature range that applies [Notes 2 & 3], unless otherwise noted.)

Characteristic	Symbol	Min	Typ	Max	Unit
<b>COMPARATOR</b>					
Threshold Voltage					V
High State Output ( $V_{in}$ Increasing)	$V_{IH}$	4.15	4.33	4.45	
Low State Output ( $V_{in}$ Decreasing)	$V_{IL}$	4.15	4.27	4.45	
Hysteresis ( $I_{Sink} = 100 \mu\text{A}$ )	$V_H$	0.02	0.09	–	
<b>RESET OUTPUT</b>					
Output Sink Saturation ( $V_{in} = 4.0 \text{ V}$ , $I_{Sink} = 1.0 \text{ mA}$ ) ( $V_{in} = 1.0 \text{ V}$ , $I_{Sink} = 0.25 \text{ mA}$ )	$V_{OL}$	–	0.14 0.1	0.4 0.3	V
Output Sink Current ( $V_{in}$ , Reset = 4.0 V)	$I_{Sink}$	7.0	20	50	mA
Output Off-State Leakage ( $V_{in}$ , Reset = 5.0 V) ( $V_{in}$ , Reset = 10 V)	$I_R(\text{leak})$	–	0.02 0.02	0.5 2.0	$\mu\text{A}$
Clamp Diode Forward Voltage, Pin 1 to 2 ( $I_F = 5.0 \text{ mA}$ )	$V_F$	0.6	0.9	1.2	V
<b>TOTAL DEVICE</b>					
Operating Input Voltage Range	$V_{in}$	1.0 to 10	–	–	V
Quiescent Input Current $V_{in} = 5.0 \text{ V}$ $V_{in} = 10 \text{ V}$	$I_{in}$	– –	12 32	20 50	$\mu\text{A}$

**NOTES:** 2. Low duty cycle pulse techniques are used during test to maintain junction temperature as close to ambient as possible.

3.  $T_{low} = 0^\circ\text{C}$  for MC34164       $T_{high} = +70^\circ\text{C}$  for MC34164  
      $-40^\circ\text{C}$  for MC33164           $= +85^\circ\text{C}$  for MC33164

**Figure 1. MC3X164–3 Reset Output Voltage versus Input Voltage**

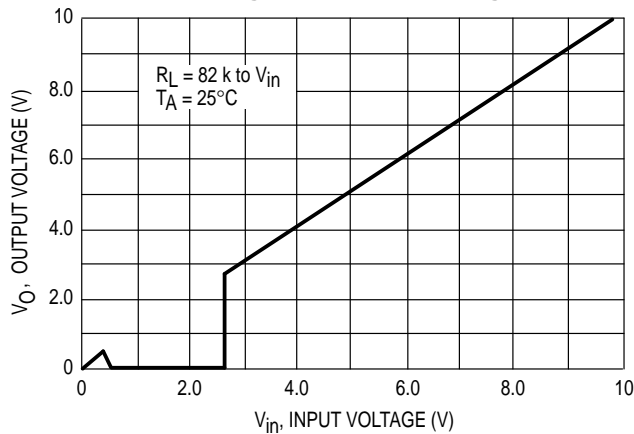

**Figure 2. MC3X164–5 Reset Output Voltage versus Input Voltage**

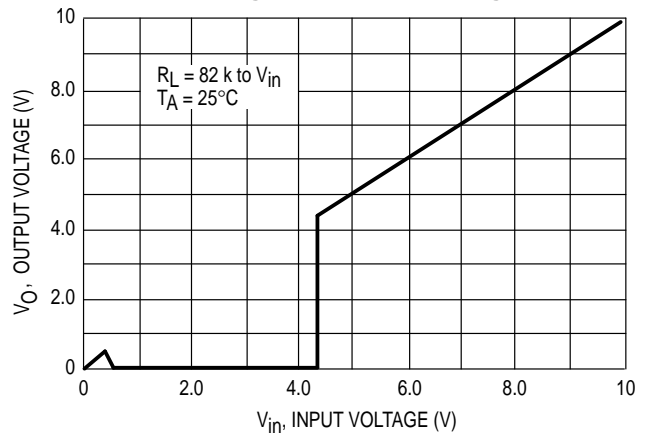

Figure 3. MC3X164-3 Reset Output Voltage versus Input Voltage

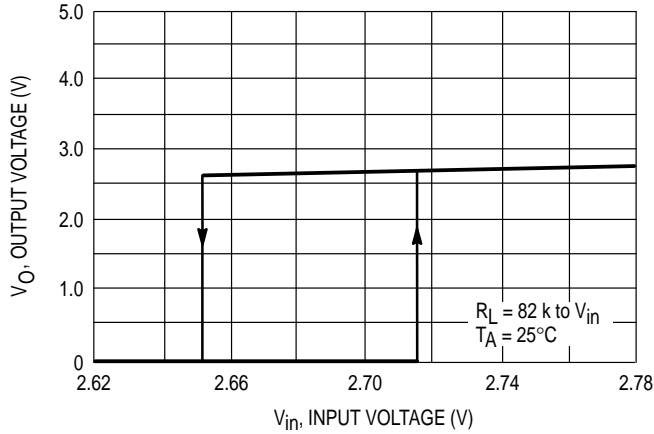

Figure 4. MC3X164-5 Reset Output Voltage versus Input Voltage

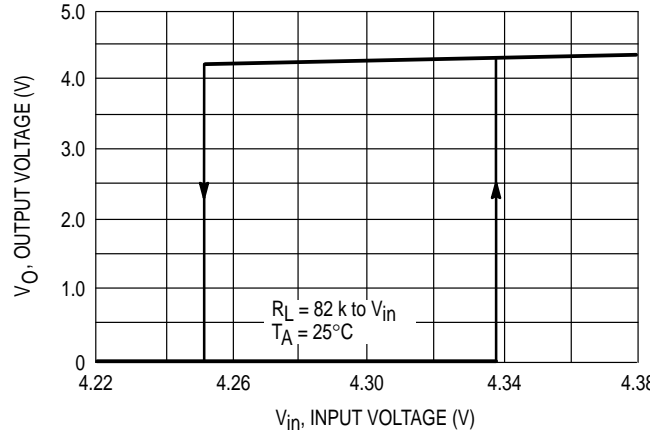

Figure 5. MC3X164-3 Comparator Threshold Voltage versus Temperature

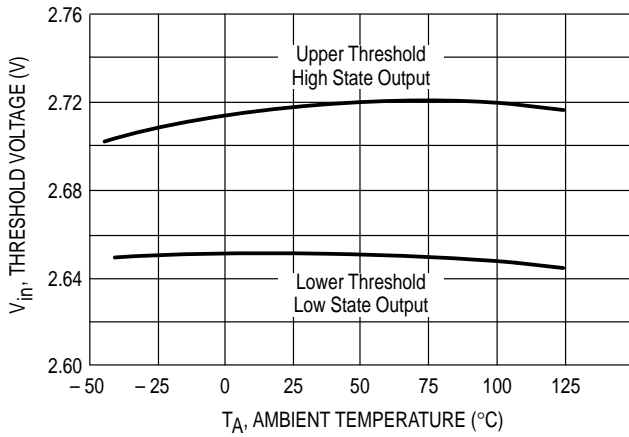

Figure 6. MC3X164-5 Comparator Threshold Voltage versus Temperature

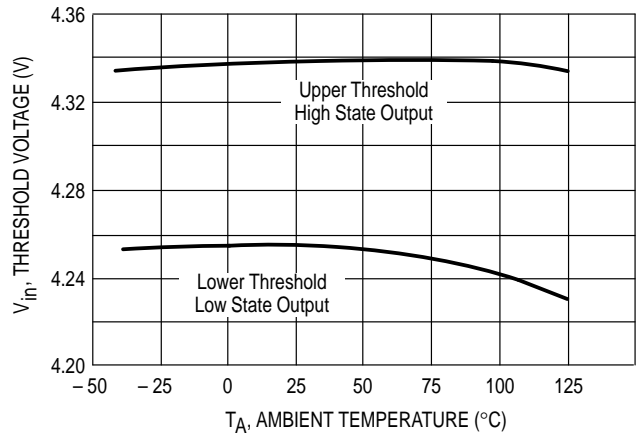

Figure 7. MC3X164-3 Input Current versus Input Voltage

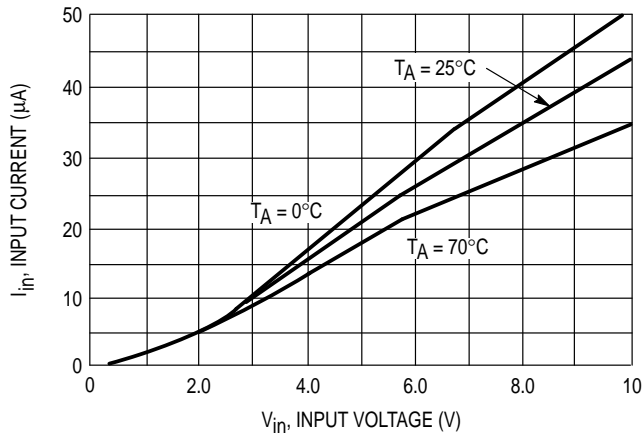

Figure 8. MC3X164-5 Input Current versus Input Voltage

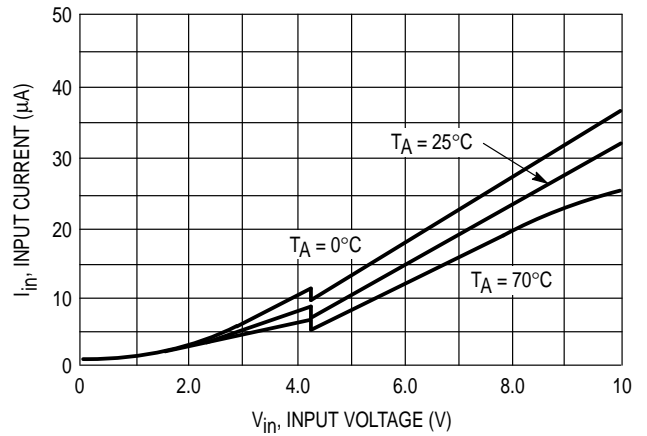

Figure 9. MC3X164-3 Reset Output Saturation versus Sink Current

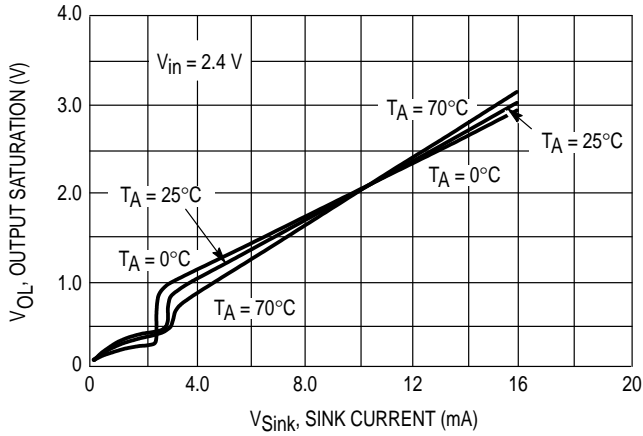

Figure 10. MC3X164-5 Reset Output Saturation versus Sink Current

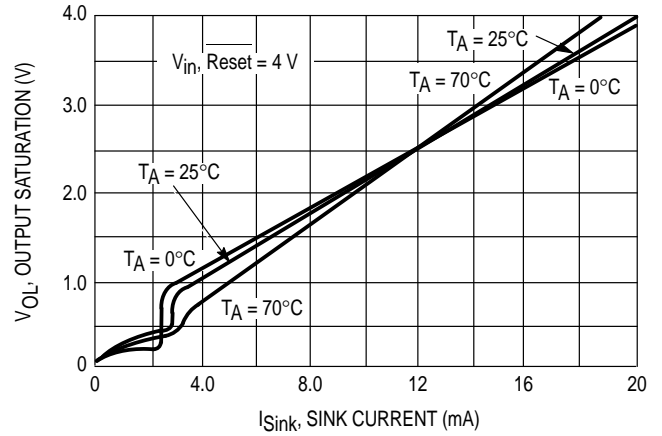

Figure 11. Clamp Diode Forward Current versus Voltage

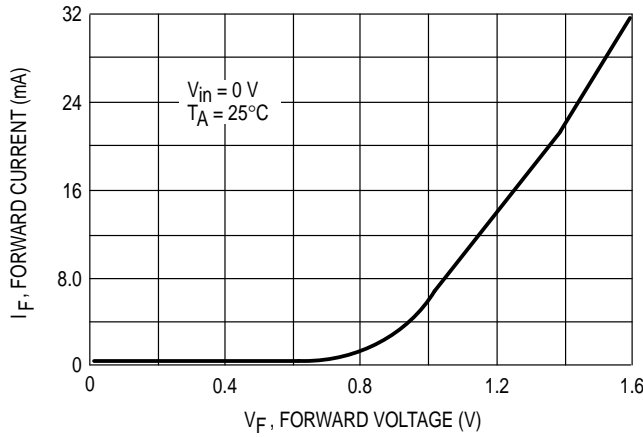

Figure 12. Reset Delay Time (MC3X164-5 Shown)

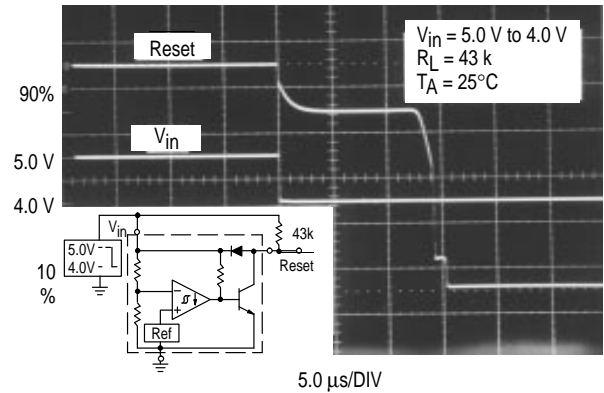
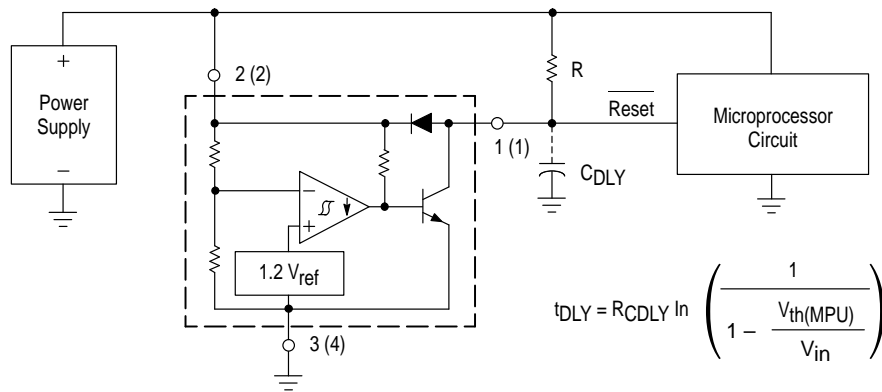

Figure 13. Low Voltage Microprocessor Reset



A time delayed reset can be accomplished with the addition of  $C_{DLY}$ . For systems with extremely fast power supply rise times ( $< 500$  ns) it is recommended that the  $RC_{DLY}$  time constant be greater than  $5.0 \mu s$ .  $V_{th}(MPU)$  is the microprocessor reset input threshold.

# MC34164 MC33164

**Figure 14. Low Voltage Microprocessor Reset With Additional Hysteresis (MC3X164-5 Shown)**

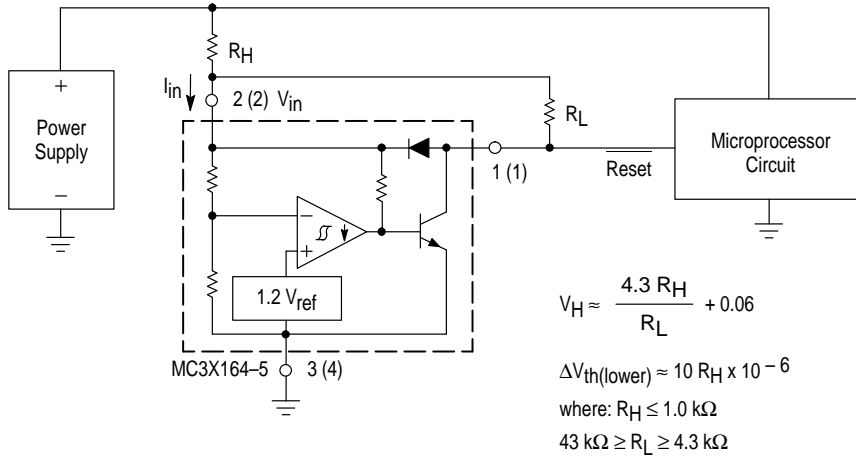

Test Data			
V <sub>H</sub> (mV)	ΔV <sub>th</sub> (mV)	R <sub>H</sub> (Ω)	R <sub>L</sub> (kΩ)
60	0	0	43
103	1.0	100	10
123	1.0	100	6.8
160	1.0	100	4.3
155	2.2	220	10
199	2.2	220	6.8
280	2.2	220	4.3
262	4.7	470	10
306	4.7	470	8.2
357	4.7	470	6.8
421	4.7	470	5.6
530	4.7	470	4.3

$$V_H \approx \frac{4.3 R_H}{R_L} + 0.06$$

$$\Delta V_{th(lower)} \approx 10 R_H \times 10^{-6}$$

where:  $R_H \leq 1.0 \text{ k}\Omega$

$43 \text{ k}\Omega \geq R_L \geq 4.3 \text{ k}\Omega$

Comparator hysteresis can be increased with the addition of resistor  $R_H$ . The hysteresis equation has been simplified and does not account for the change of input current  $I_{in}$  as  $V_{in}$  crosses the comparator threshold (Figure 8). An increase of the lower threshold  $\Delta V_{th(lower)}$  will be observed due to  $I_{in}$  which is typically  $10 \mu\text{A}$  at  $4.3 \text{ V}$ . The equations are accurate to  $\pm 10\%$  with  $R_H$  less than  $1.0 \text{ k}\Omega$  and  $R_L$  between  $4.3 \text{ k}\Omega$  and  $43 \text{ k}\Omega$ .

**Figure 15. Voltage Monitor**

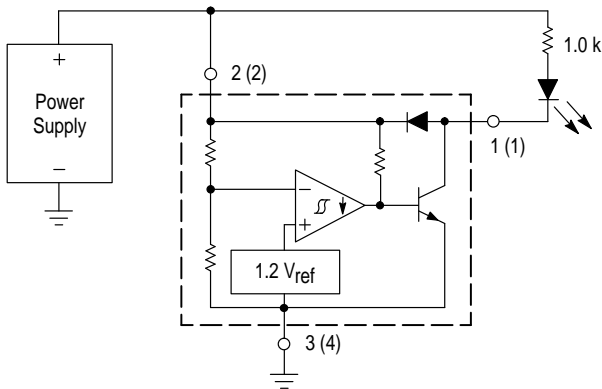

**Figure 16. Solar Powered Battery Charger**

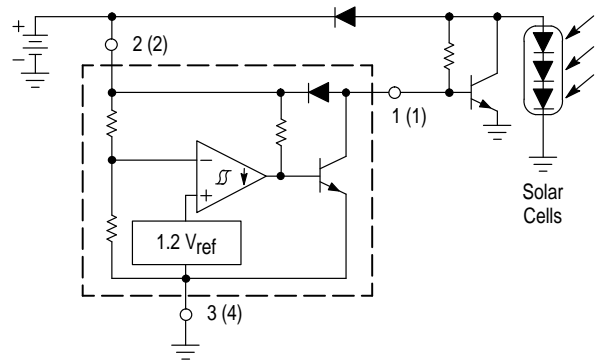

**Figure 17. MOSFET Low Voltage Gate Drive Protection Using the MC3X164-5**

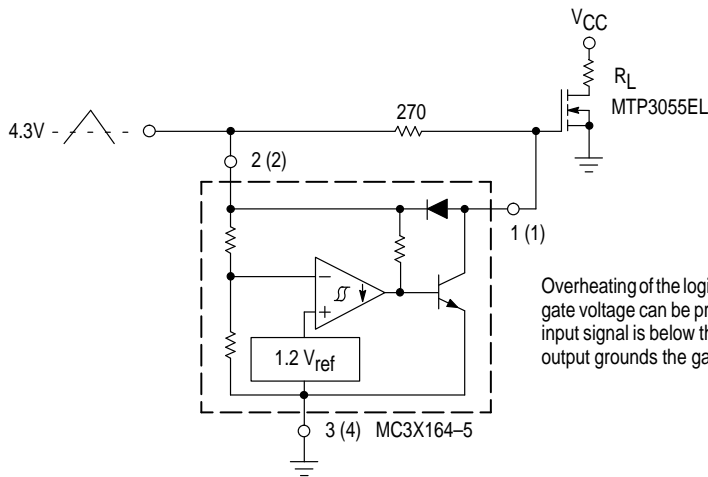

Overheating of the logic level power MOSFET due to insufficient gate voltage can be prevented with the above circuit. When the input signal is below the  $4.3 \text{ V}$  threshold of the MC3X164-5, its output grounds the gate of the L<sup>2</sup> MOSFET.

# MC34164 MC33164

## OUTLINE DIMENSIONS

### P SUFFIX PLASTIC PACKAGE CASE 29-04 (TO-226AA) ISSUE AD

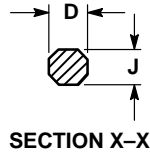
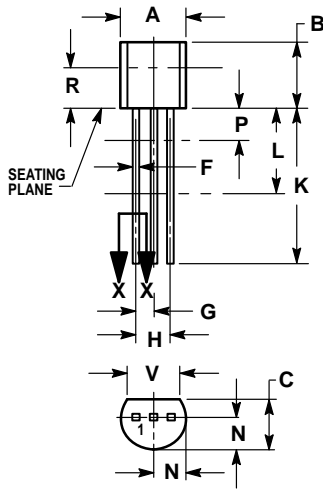

- NOTES:
1. DIMENSIONING AND TOLERANCING PER ANSI Y14.5M, 1982.
  2. CONTROLLING DIMENSION: INCH.
  3. CONTOUR OF PACKAGE BEYOND DIMENSION R IS UNCONTROLLED.
  4. DIMENSION F APPLIES BETWEEN P AND L. DIMENSION D AND J APPLY BETWEEN L AND K. MINIMUM LEAD DIMENSION IS UNCONTROLLED IN P AND BEYOND DIMENSION K MINIMUM.

DIM	INCHES		MILLIMETERS	
	MIN	MAX	MIN	MAX
A	0.175	0.205	4.45	5.20
B	0.170	0.210	4.32	5.33
C	0.125	0.165	3.18	4.19
D	0.016	0.022	0.41	0.55
F	0.016	0.019	0.41	0.48
G	0.045	0.055	1.15	1.39
H	0.095	0.105	2.42	2.66
J	0.015	0.020	0.39	0.50
K	0.500	—	12.70	—
L	0.250	—	6.35	—
N	0.080	0.105	2.04	2.66
P	—	0.100	—	2.54
R	0.115	—	2.93	—
V	0.135	—	3.43	—

### D SUFFIX PLASTIC PACKAGE CASE 751-05 (SO-8) ISSUE P

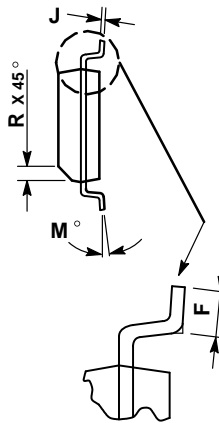
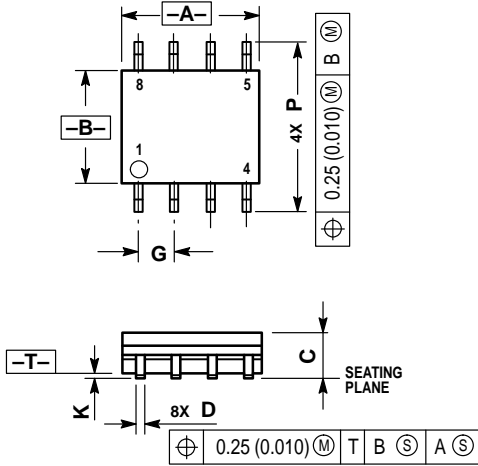

- NOTES:
1. DIMENSIONS A AND B ARE DATUMS AND T IS A DATUM SURFACE.
  2. DIMENSIONING AND TOLERANCING PER ANSI Y14.5M, 1982.
  3. DIMENSIONS ARE IN MILLIMETER.
  4. DIMENSION A AND B DO NOT INCLUDE MOLD PROTRUSION.
  5. MAXIMUM MOLD PROTRUSION 0.15 PER SIDE.
  6. DIMENSION D DOES NOT INCLUDE MOLD PROTRUSION. ALLOWABLE DAMBAR PROTRUSION SHALL BE 0.127 TOTAL IN EXCESS OF THE D DIMENSION AT MAXIMUM MATERIAL CONDITION.

DIM	MILLIMETERS	
	MIN	MAX
A	4.80	5.00
B	3.80	4.00
C	1.35	1.75
D	0.35	0.49
F	0.40	1.25
G	1.27 BSC	—
J	0.18	0.25
K	0.10	0.25
M	0°	7°
P	5.80	6.20
R	0.25	0.50

# MC34164 MC33164

## OUTLINE DIMENSIONS

DM SUFFIX  
PLASTIC PACKAGE  
CASE 846A-02  
(Micro-8)  
ISSUE B

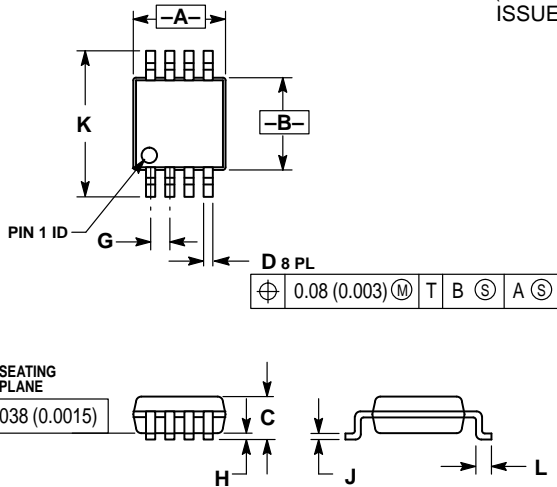

### NOTES:

1. DIMENSIONING AND TOLERANCING PER ANSI Y14.5M, 1982.
2. CONTROLLING DIMENSION: MILLIMETER.
3. DIMENSION A DOES NOT INCLUDE MOLD FLASH, PROTRUSIONS OR GATE BURRS. MOLD FLASH, PROTRUSIONS OR GATE BURRS SHALL NOT EXCEED 0.15 (0.006) PER SIDE.
4. DIMENSION D DOES NOT INCLUDE INTERLEAD FLASH OR PROTRUSION. INTERLEAD FLASH OR PROTRUSION SHALL NOT EXCEED 0.25 (0.010) PER SIDE.

DIM	MILLIMETERS		INCHES	
	MIN	MAX	MIN	MAX
A	2.90	3.10	0.114	0.122
B	2.90	3.10	0.114	0.122
C	—	1.10	—	0.043
D	0.25	0.40	0.010	0.016
G	0.65 BSC		0.026 BSC	
H	0.05	0.15	0.002	0.006
J	0.13	0.23	0.005	0.009
K	4.75	5.05	0.187	0.199
L	0.40	0.70	0.016	0.028

Motorola reserves the right to make changes without further notice to any products herein. Motorola makes no warranty, representation or guarantee regarding the suitability of its products for any particular purpose, nor does Motorola assume any liability arising out of the application or use of any product or circuit, and specifically disclaims any and all liability, including without limitation consequential or incidental damages. "Typical" parameters which may be provided in Motorola data sheets and/or specifications can and do vary in different applications and actual performance may vary over time. All operating parameters, including "Typicals" must be validated for each customer application by customer's technical experts. Motorola does not convey any license under its patent rights nor the rights of others. Motorola products are not designed, intended, or authorized for use as components in systems intended for surgical implant into the body, or other applications intended to support or sustain life, or for any other application in which the failure of the Motorola product could create a situation where personal injury or death may occur. Should Buyer purchase or use Motorola products for any such unintended or unauthorized application, Buyer shall indemnify and hold Motorola and its officers, employees, subsidiaries, affiliates, and distributors harmless against all claims, costs, damages, and expenses, and reasonable attorney fees arising out of, directly or indirectly, any claim of personal injury or death associated with such unintended or unauthorized use, even if such claim alleges that Motorola was negligent regarding the design or manufacture of the part. Motorola and  are registered trademarks of Motorola, Inc. Motorola, Inc. is an Equal Opportunity/Affirmative Action Employer.

### How to reach us:

**USA/EUROPE/Locations Not Listed:** Motorola Literature Distribution;  
P.O. Box 20912; Phoenix, Arizona 85036. 1-800-441-2447 or 602-303-5454

**JAPAN:** Nippon Motorola Ltd.; Tatsumi-SPD-JLDC, 6F Seibu-Butsuryu-Center,  
3-14-2 Tatsumi Koto-Ku, Tokyo 135, Japan. 03-81-3521-8315

**MFAX:** RMFAX0@email.sps.mot.com – TOUCHTONE 602-244-6609  
**INTERNET:** <http://Design-NET.com>

**ASIA/PACIFIC:** Motorola Semiconductors H.K. Ltd.; 8B Tai Ping Industrial Park,  
51 Ting Kok Road, Tai Po, N.T., Hong Kong. 852-26629298



MC34164/D





This datasheet has been download from:

[www.datasheetcatalog.com](http://www.datasheetcatalog.com)

Datasheets for electronics components.