



GENERAL DESCRIPTION

The M670 is a VCISO (Voltage Controlled SAW Oscillator) frequency source for low-jitter clock generation. Its integrated SAW (surface acoustic wave) delay line provides low phase jitter. The M670 is available in a range of center frequencies. Minimum pull-range is ± 50 ppm (wider pull-range available).



The M670 is well suited for phase-locked loop implementations, clock and data recovery circuits, and other timing applications for the telecom and optical fiber networking markets (e.g., OC-48, OC-192).

PIN ASSIGNMENT (5 x 7mm SMT)

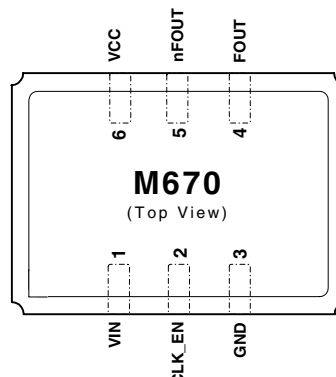

Figure 1: Pin Assignment

FEATURES

- ◆ VCISO center frequencies from 155 to 700 MHz (Specify center frequency at time of order)
- ◆ Low phase jitter 0.19ps rms typical (50kHz-80MHz)
- ◆ Low phase noise -70dBc/Hz @ 1kHz offset
- ◆ Differential 3.3V LVPECL output
- ◆ Single 3.3V power supply
- ◆ Very small 5 x 7mm SMT (surface mount) package

Sample of Available Output Frequencies

VCISO Center Frequency ¹ (MHz)	Applications
622.0800	SONET/SDH
625.0000	Gigabit Ethernet
644.5313	Gigabit Ethernet FEC
669.3265	SONET/SDH FEC

Table 1: Sample of Available Output Frequencies

Note 1: Specify VCISO center frequency at time of order

BLOCK DIAGRAM

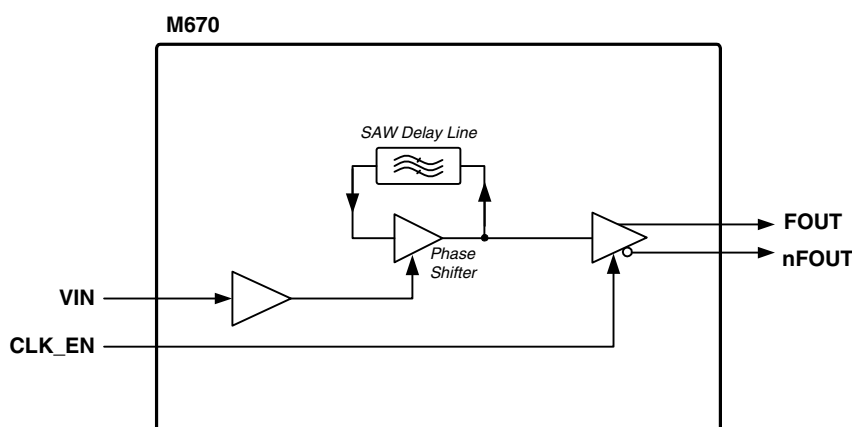

Figure 2: Block Diagram



PIN DESCRIPTIONS

Number	Name	I/O	Configuration	Description
1	VIN	Input		Tuning control voltage.
2	CLK_EN	Input		Clock enable: Logic 1 enables normal operation. Logic 0 stops the output clock; nFOUT is held high, FOUT is held low.
3	GND	Ground		Power supply ground connections.
4	FOUT	Output	No internal terminator	Clock output pair. Differential LVPECL.
5	nFOUT			
6	VCC	Power		Power supply connection, connect to +3.3V.

Table 2: Pin Descriptions

ABSOLUTE MAXIMUM RATINGS¹

Symbol	Parameter	Rating	Unit
V_I	Inputs	-0.5 to $V_{CC} + 0.5$	V
V_O	Outputs	-0.5 to $V_{CC} + 0.5$	V
V_{CC}	Power Supply Voltage	3.63	V
T_S	Storage Temperature	-55 to +125	°C

Table 3: Absolute Maximum Ratings

Note 1: Stresses beyond those listed under Absolute Maximum Ratings may cause permanent damage to the device. These ratings are stress specifications only. Functional operation of product at these conditions or any conditions beyond those listed in [Recommended Conditions of Operation](#), [DC Characteristics](#), or [AC Characteristics](#) is not implied. Exposure to absolute maximum rating conditions for extended periods may affect product reliability.

RECOMMENDED CONDITIONS OF OPERATION

Symbol	Parameter	Min	Typ	Max	Unit
V_{CC}	Positive Supply Voltage	2.97	3.3	3.63	V
T_A	Ambient Operating Temperature	-40	25	+85	°C

Table 4: Recommended Conditions of Operation



ELECTRICAL SPECIFICATIONS

DC Characteristics

Unless stated otherwise, $V_{CC} = 3.3 \text{ Volts} \pm 10\%$, $T_A = 0 \text{ to } 85^\circ\text{C}$, VCSO Frequency = 622-695MHz, Outputs terminated into 180Ω to ground

	Symbol	Parameter	Pin	Min	Typ	Max	Unit
Power Supply	V_{CC}	Positive Supply Voltage	VCC	2.97	3.3	3.63	V
	I_{CC}	Power Supply Current		80	100	mA	
Control Voltage	V_{IN}	Input Control Voltage Range		0		V_{CC}	V
		V_{IN} Input Impedence	VIN		100		k Ω
		V_{IN} Modulation Bandwidth			500		kHz
Clock Enable Pull-up	V_{IH}	Input High Voltage		2		$V_{CC} + 0.3$	V
	V_{IL}	Input Low Voltage		-0.3		0.8	V
	I_{IH}	Input High Current	CLK_EN			5	μA
	I_{IL}	Input Low Current		-150			μA
	R_{pullup}	Internal Pull-up Resistor			51		k Ω
Differential Outputs	V_{OH}	Output High Voltage		$V_{CC} - 0.98$		$V_{CC} - 0.75$	V
	V_{OL}	Output Low Voltage		$V_{CC} - 1.95$		$V_{CC} - 1.63$	V
	V_{P-P}	Peak to Peak Output Voltage	FOUT, nFOUT	0.4	0.6	0.85	V_{P-P}
	I_{OUT}	Output Current				20	mA

Table 5: DC Characteristics

AC Characteristics

Unless stated otherwise, $V_{CC} = 3.3 \text{ Volts} \pm 10\%$, $T_A = 0 \text{ to } 85^\circ\text{C}$, VCSO Frequency = 622-695MHz, Outputs terminated into 180Ω to ground

	Symbol	Parameter	Min	Typ	Max	Unit	Notes	
Frequency	F_{OUT}	Output Center Frequency Range	155		700	MHz		
	APR	Absolute Pull-Range ¹	± 50			ppm		
	f_{STAB}	Frequency Stability		110		ppm p-p		
	L_{IN}	Tuning Linearity		6		%		
	K_{VCO}	VCO Gain	@622.08MHz		265		ppm/V	$V_{IN} = 0.3 \text{ to } 3.0\text{V}$ Best fit straight line
Outputs		Non-harmonic Spurious	-50	-70		dBc		
	Φ_n	SSB Phase Noise offset from carrier	100Hz Offset		-43		dBc/Hz	
			1kHz Offset		-70		dBc/Hz	
			10kHz Offset		-98		dBc/Hz	
			100kHz Offset		-124		dBc/Hz	
	J(t)	Jitter (rms)	12kHz to 20MHz		0.36		ps rms	
			50kHz to 80MHz		0.19		ps rms	
odc	Output Duty Cycle ²	45		55		%		
t_R	Output Rise Time ² for FOUT, nFOUT		300	400		ps	20% to 80%	
t_F	Output Fall Time ² for FOUT, nFOUT		300	400		ps	20% to 80%	

Table 6: AC Characteristics

Note 1: Consult ICS for availability of other APRs.

Note 2: See [Parameter Measurement Information](#) on pg. 4.



PARAMETER MEASUREMENT INFORMATION

Output Rise and Fall Time

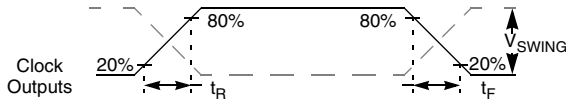

Figure 3: Output Rise and Fall Time

Output Duty Cycle

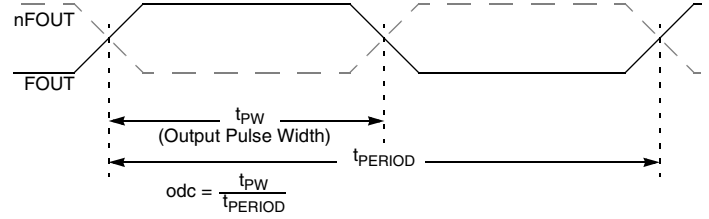

Figure 4: Output Duty Cycle

TEST DATA

Broadband Jitter

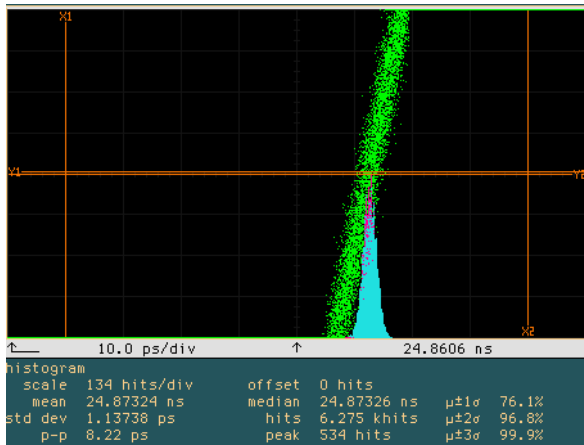

Figure 5: Broadband Jitter

Output Waveform

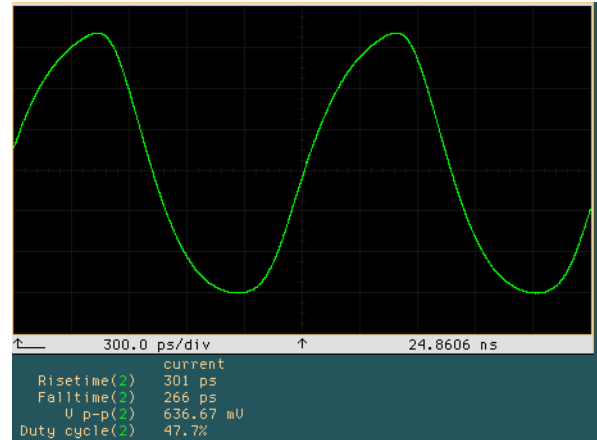

Figure 7: Output Waveform

Linearity

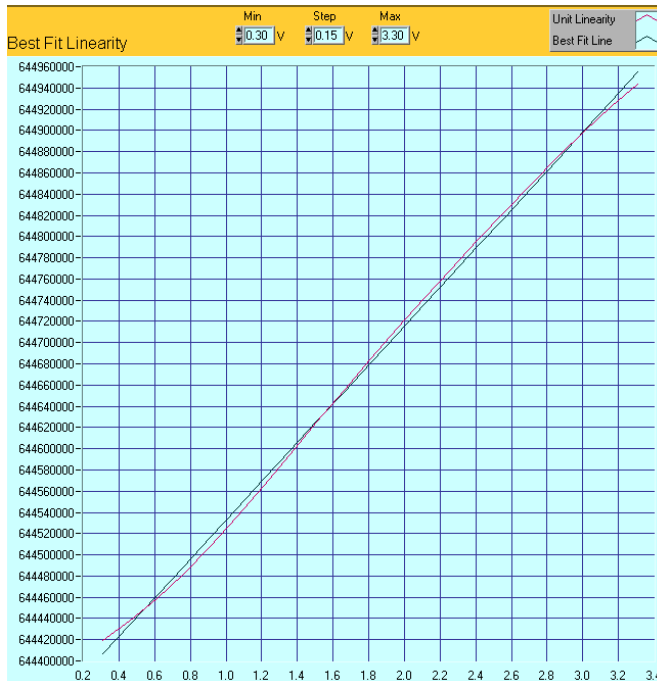

Figure 6: Linearity

Phase Noise

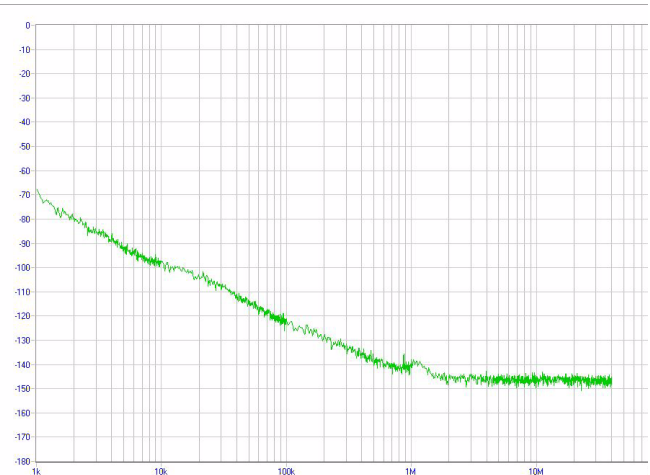

Figure 8: Phase Noise



DEVICE PACKAGE - 5 x 7mm SMT (Surface Mount) Package

Mechanical Dimensions:

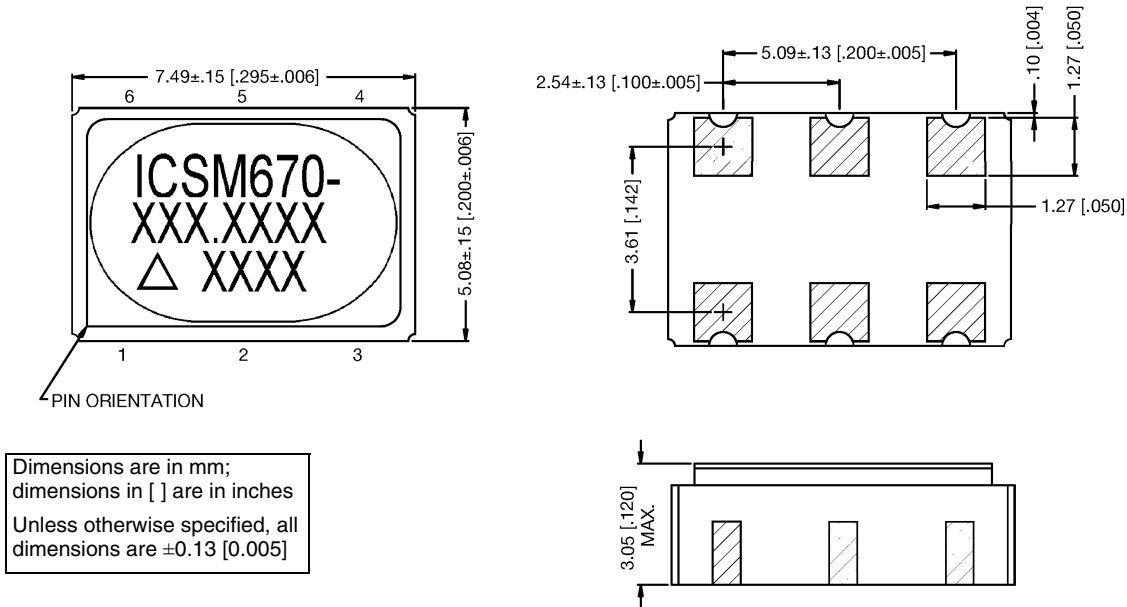

Figure 9: Device Package - 5 x 7mm SMT (Surface Mount) Package

ORDERING INFORMATION

For Output Frequency (MHz)	Order Part Number
xxx.xxxx	M670-xxx.xxxx
e.g., 622.0800	M670-622.0800

Table 7: Ordering Information

Standard Output Frequencies

155.5200	622.0800
156.2500	625.0000
156.8324	627.3296
161.1328	644.5313
166.6286	666.5143
167.2820	669.1281
167.3280	669.3120
167.3316	669.3265
167.7097	670.8386
168.0400	672.1600
172.6423	690.5692
173.3708	693.4830

Table 8: Standard Output Frequencies

Consult ICS for the availability of other VCSO frequencies.

While the information presented herein has been checked for both accuracy and reliability, Integrated Circuit Systems (ICS) assumes no responsibility for either its use or for the infringement of any patents or other rights of third parties, which would result from its use. No other circuits, patents, or licenses are implied. This product is intended for use in normal commercial applications. Any other applications such as those requiring extended temperature range, high reliability, or other extraordinary environmental requirements are not recommended without additional processing by ICS. ICS reserves the right to change any circuitry or specifications without notice. ICS does not authorize or warrant any ICS product for use in life support devices or critical medical instruments.



Integrated
Circuit
Systems, Inc.

M670

VOLTAGE CONTROLLED SAW OSCILLATOR

Product Data Sheet

This datasheet has been downloaded from:

www.DatasheetCatalog.com

Datasheets for electronic components.