

FEATURES

- 8th Order Elliptic Filter in SO-8 Package
- Operates from Single 3.3V to $\pm 5V$ Power Supplies
- -20dB at $1.2f_{\text{CUTOFF}}$
- -52dB at $1.4f_{\text{CUTOFF}}$
- -70dB at $2f_{\text{CUTOFF}}$
- Wide Dynamic Range
- $110\mu\text{V}_{\text{RMS}}$ Wideband Noise
- 3.8mA Supply Current with $\pm 5V$ Supplies
- 2.5mA Supply Current with Single $5V$ Supply
- 2mA Supply Current with Single $3.3V$ Supply

APPLICATIONS

- Telecommunication Filters
- Antialiasing Filters

DESCRIPTION

The LTC[®]1069-1 is a monolithic 8th order lowpass filter featuring clock-tunable cutoff frequency and 2.5mA power supply current with a single $5V$ supply. An additional feature of the LTC1069-1 is operation with a single $3.3V$ supply.

The cutoff frequency (f_{CUTOFF}) of the LTC1069-1 is equal to the clock frequency divided by 100. The gain at f_{CUTOFF} is -0.7dB and the typical passband ripple is $\pm 0.15\text{dB}$ up to $0.9f_{\text{CUTOFF}}$. The stopband attenuation of the LTC1069-1 features a progressive elliptic response reaching 20dB attenuation at $1.2f_{\text{CUTOFF}}$, 52dB attenuation at $1.4f_{\text{CUTOFF}}$ and 70dB attenuation at $2f_{\text{CUTOFF}}$.

With $\pm 5V$ supplies, the LTC1069-1 cutoff frequency can be clock-tuned up to 12kHz ; with a single $5V$ supply, the maximum cutoff frequency is 8kHz .

The low power feature of the LTC1069-1 does not penalize the device's dynamic range. With $\pm 5V$ supplies and an input range of $0.3V_{\text{RMS}}$ to $2.5V_{\text{RMS}}$, the signal-to-(noise + THD) ratio is $\geq 70\text{dB}$. The wideband noise of the LTC1069-1 is $110\mu\text{V}_{\text{RMS}}$. **Other filter responses with lower power or higher speed can be obtained. Please contact LTC marketing for details.**

The LTC1069-1 is available in 8-pin PDIP and 8-pin SO packages.

 LTC and LT are registered trademarks of Linear Technology Corporation.

TYPICAL APPLICATION

Single 3.3V Supply 3kHz Elliptic Lowpass Filter

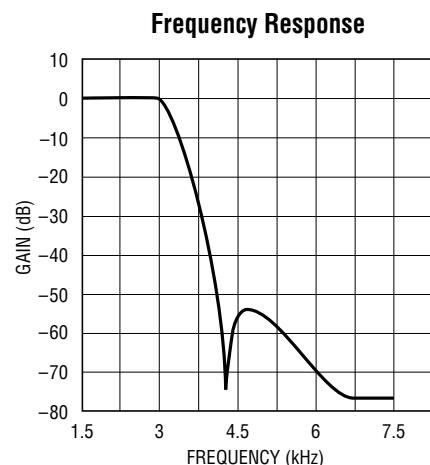
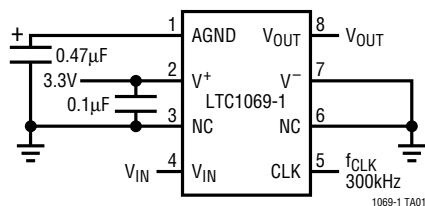

1069-1 TA02

ABSOLUTE MAXIMUM RATINGS

Total Supply Voltage (V^+ to V^-)	12V
Maximum Voltage at Any Pin	$(V^- - 0.3V) \leq V \leq (V^+ + 0.3V)$
Operating Temperature Range	
LTC1069-1C	0°C to 70°C
LTC1069-1I	-40°C to 85°C
Storage Temperature Range	-65°C to 150°C
Lead Temperature (Soldering, 10 sec).....	300°C

PACKAGE/ORDER INFORMATION

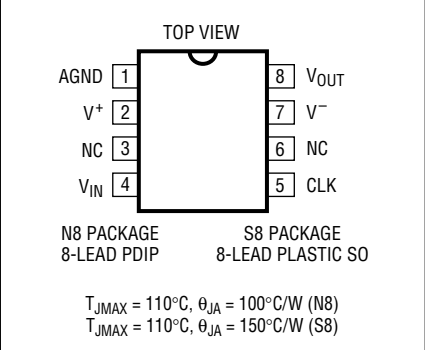
	ORDER PART NUMBER
	LTC1069-1CN8 LTC1069-1CS8 LTC1069-1IN8 LTC1069-1IS8
	S8 PART NUMBER
	10691 10691I

Consult factory for Military grade parts.

ELECTRICAL CHARACTERISTICS

f_{CUTOFF} is the filter's cutoff frequency and is equal to $f_{CLK}/100$. The f_{CLK} signal level is TTL or CMOS (clock rise or fall time $\leq 1\mu s$), $V_S = 3.3V$ to $\pm 5V$, $R_L = 10k$, $T_A = 25^\circ C$, unless otherwise noted. All AC gains are measured relative to the passband gain.

PARAMETER	CONDITIONS	MIN	TYP	MAX	UNITS
Passband Gain ($f_{IN} \leq 0.25f_{CUTOFF}$)	$V_S = \pm 5V$, $f_{TEST} = 1.25kHz$, $f_{CLK} = 500kHz$, $V_{IN} = 1V_{RMS}$	-0.30 -0.35	0.2	0.70 0.75	dB dB
	$V_S = 3.3V$, $f_{TEST} = 0.5kHz$, $f_{CLK} = 200kHz$, $V_{IN} = 0.5V_{RMS}$	-0.30 -0.35	0.2	0.70 0.75	dB dB
Gain at $0.50f_{CUTOFF}$	$V_S = \pm 5V$, $f_{TEST} = 2.5kHz$, $f_{CLK} = 500kHz$, $V_{IN} = 1V_{RMS}$	-0.10 -0.11	-0.03	0.10 0.11	dB dB
	$V_S = 3.3V$, $f_{TEST} = 1kHz$, $f_{CLK} = 200kHz$, $V_{IN} = 0.5V_{RMS}$	-0.10 -0.11	-0.03	0.10 0.11	dB dB
Gain at $0.75f_{CUTOFF}$	$V_S = \pm 5V$, $f_{TEST} = 3.75kHz$, $f_{CLK} = 500kHz$, $V_{IN} = 1V_{RMS}$	-0.20 -0.25	0.04	0.20 0.25	dB dB
	$V_S = 3.3V$, $f_{TEST} = 1.5kHz$, $f_{CLK} = 200kHz$, $V_{IN} = 0.5V_{RMS}$	-0.20 -0.25	0.04	0.20 0.25	dB dB
Gain at $0.90f_{CUTOFF}$	$V_S = \pm 5V$, $f_{TEST} = 4.5kHz$, $f_{CLK} = 500kHz$, $V_{IN} = 1V_{RMS}$	-0.20 -0.25	-0.01	0.20 0.25	dB dB
	$V_S = 3.3V$, $f_{TEST} = 1.8kHz$, $f_{CLK} = 200kHz$, $V_{IN} = 0.5V_{RMS}$	-0.20 -0.25	-0.01	0.20 0.25	dB dB
Gain at $0.95f_{CUTOFF}$	$V_S = \pm 5V$, $f_{TEST} = 4.75kHz$, $f_{CLK} = 500kHz$, $V_{IN} = 1V_{RMS}$	-0.30 -0.35	-0.05	0.30 0.35	dB dB
	$V_S = 3.3V$, $f_{TEST} = 1.9kHz$, $f_{CLK} = 200kHz$, $V_{IN} = 0.5V_{RMS}$	-0.30 -0.35	-0.04	0.30 0.35	dB dB
Gain at f_{CUTOFF}	$V_S = \pm 5V$, $f_{TEST} = 5.0kHz$, $f_{CLK} = 500kHz$, $V_{IN} = 1V_{RMS}$	-1.25 -1.35	-0.70	-0.25 -0.15	dB dB
	$V_S = 3.3V$, $f_{TEST} = 2.0kHz$, $f_{CLK} = 200kHz$, $V_{IN} = 0.5V_{RMS}$	-1.25 -1.35	-0.61	-0.25 -0.15	dB dB
Gain at $1.25f_{CUTOFF}$	$V_S = \pm 5V$, $f_{TEST} = 6.25kHz$, $f_{CLK} = 500kHz$, $V_{IN} = 1V_{RMS}$	-30 -31	-27	-25 -24	dB dB
	$V_S = 3.3V$, $f_{TEST} = 2.5kHz$, $f_{CLK} = 200kHz$, $V_{IN} = 0.5V_{RMS}$	-30 -31	-27	-25 -24	dB dB

ELECTRICAL CHARACTERISTICS

f_{CUTOFF} is the filter's cutoff frequency and is equal to $f_{\text{CLK}}/100$. The f_{CLK} signal level is TTL or CMOS (clock rise or fall time $\leq 1\mu\text{s}$), $V_S = 3.3\text{V}$ to $\pm 5\text{V}$, $R_L = 10\text{k}$, $T_A = 25^\circ\text{C}$, unless otherwise noted. All AC gains are measured relative to the passband gain.

PARAMETER	CONDITIONS	MIN	TYP	MAX	UNITS
Gain at $1.50f_{\text{CUTOFF}}$	$V_S = \pm 5\text{V}$, $f_{\text{TEST}} = 7.5\text{kHz}$, $f_{\text{CLK}} = 500\text{kHz}$, $V_{\text{IN}} = 1\text{V}_{\text{RMS}}$	-58 -59	-53	-50 -49	dB dB
	$V_S = 3.3\text{V}$, $f_{\text{TEST}} = 3\text{kHz}$, $f_{\text{CLK}} = 200\text{kHz}$, $V_{\text{IN}} = 0.5\text{V}_{\text{RMS}}$	-58 -59	-53	-50 -49	dB dB
Output DC Offset (Input at AGND)	$V_S = \pm 5\text{V}$, $f_{\text{CLK}} = 500\text{kHz}$		30	150	mV
	$V_S = 4.75\text{V}$, $f_{\text{CLK}} = 400\text{kHz}$		20		mV
	$V_S = 3.3\text{V}$, $f_{\text{CLK}} = 200\text{kHz}$		15	100	mV
Output Voltage Swing	$V_S = \pm 5\text{V}$	-3.25	± 4.0	3.25	V
	$V_S = 4.75\text{V}$	-1.50	± 1.7	1.25	V
	$V_S = 3.3\text{V}$	-0.70	± 0.9	0.60	V
Power Supply Current	$V_S = \pm 5\text{V}$, $f_{\text{CLK}} = 500\text{kHz}$		3.8	5.5	mA
	$V_S = 4.75\text{V}$, $f_{\text{CLK}} = 400\text{kHz}$		2.5	4.5	mA
	$V_S = 3.3\text{V}$, $f_{\text{CLK}} = 200\text{kHz}$		2.0	3.5	mA
Maximum Clock Frequency	$V_S = \pm 5\text{V}$		1.2		MHz
	$V_S = 4.75\text{V}$		0.8		MHz
	$V_S = 3.3\text{V}$		0.5		MHz
Input Frequency Range		0		$f_{\text{CLK}}/2$	MHz
Input Resistance		30	43	70	$\text{k}\Omega$
Operating Power Supply Voltage		± 1.57		± 5.5	V

The ● denotes specifications which apply over the full operating temperature range.

TYPICAL PERFORMANCE CHARACTERISTICS

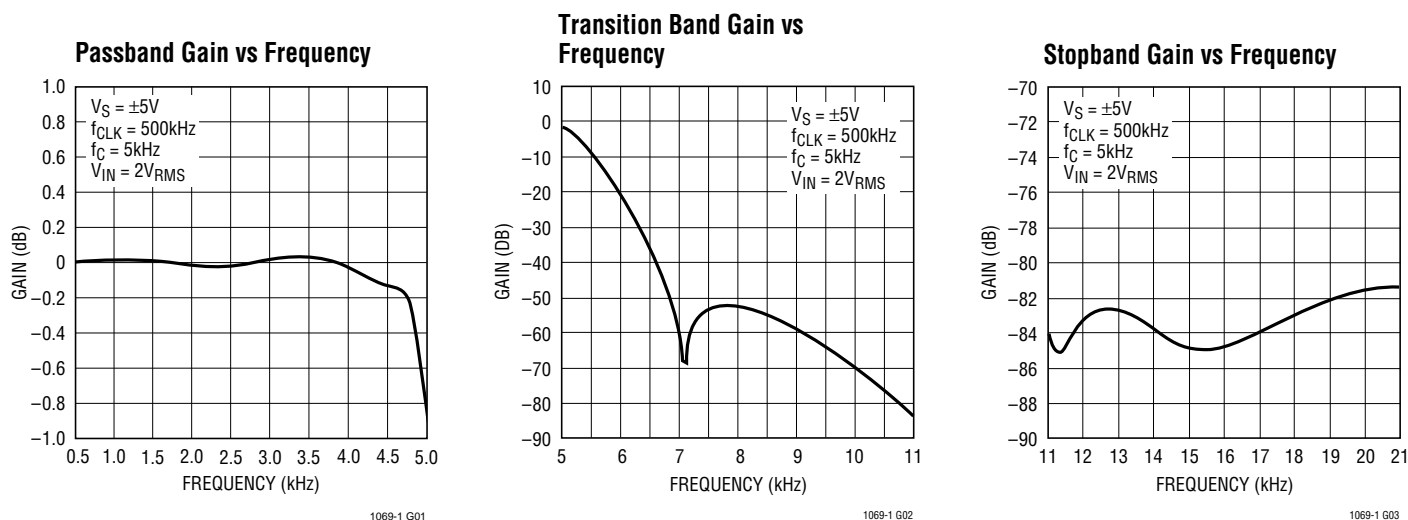

TYPICAL PERFORMANCE CHARACTERISTICS

Passband Gain vs Clock Frequency, V_S = Single 3.3V

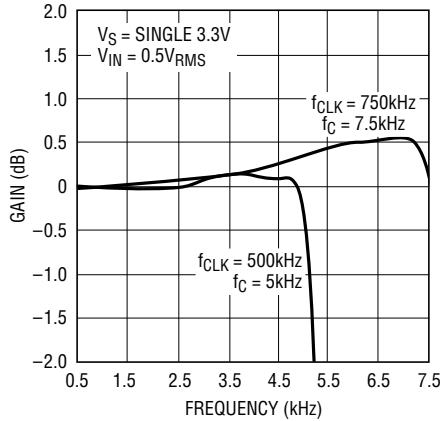

1069-1 G04

Passband Gain vs Clock Frequency, V_S = Single 5V

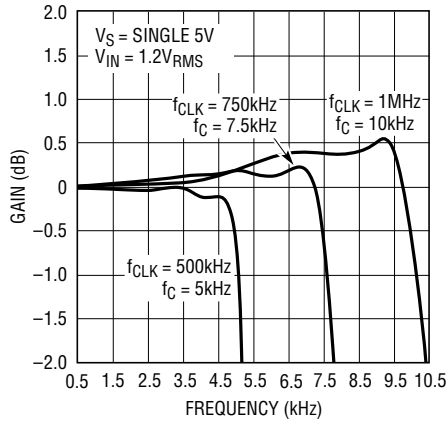

1069-1 G05

Passband Gain vs Clock Frequency, V_S = ±5V

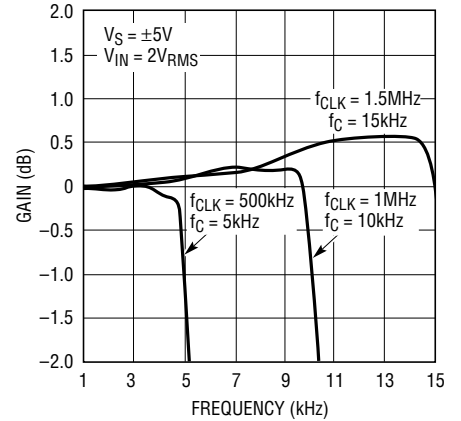

1069-1 G06

Gain vs Supply Voltage

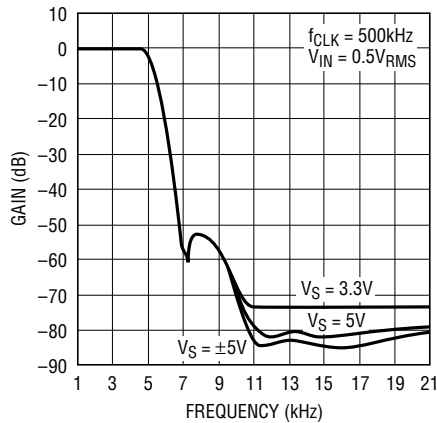

1069-1 G07

Phase and Group Delay vs Frequency

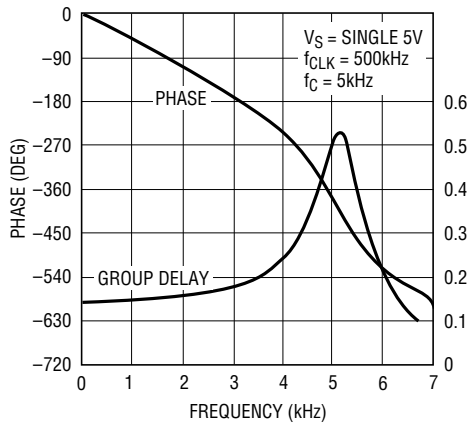

1069-1 G08

Transient Response

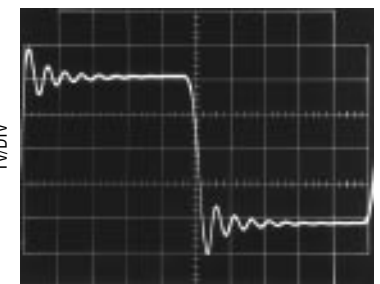

$V_S = \pm 5V$
 $f_{CLK} = 1MHz$
 $f_{IN} = 500Hz$
4V_{P-P} SQUARE WAVE

1069-1 G09

Dynamic Range THD + Noise vs V_{IN} (V_{RMS})

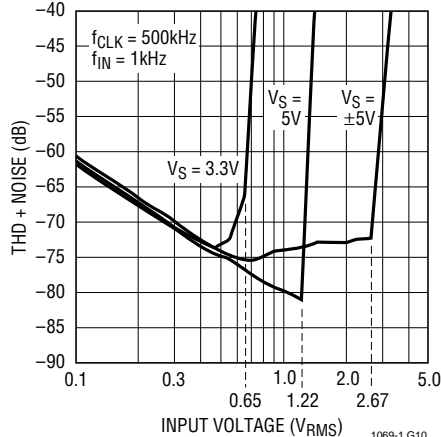

1069-1 G10

THD + Noise vs Frequency

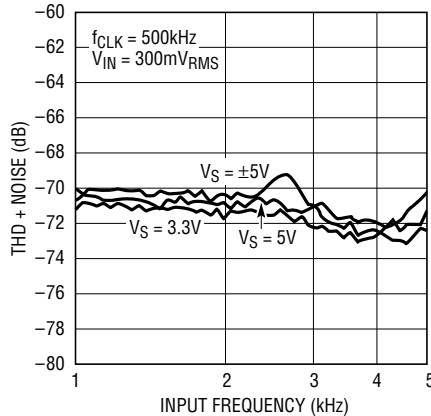

1069-1 G11

THD + Noise vs Frequency

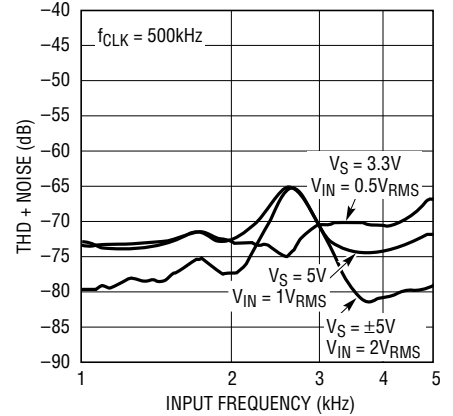

1069-1 G12

TYPICAL PERFORMANCE CHARACTERISTICS

Supply Current vs Supply Voltage

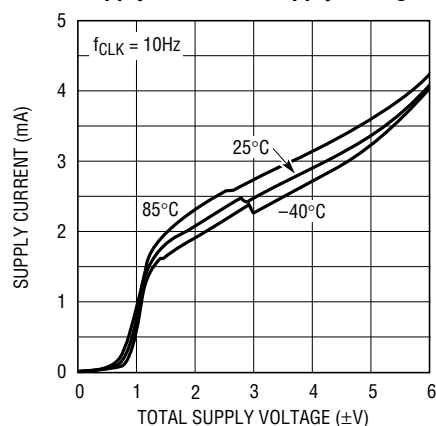

1069-1 G13

Supply Current vs Clock Frequency

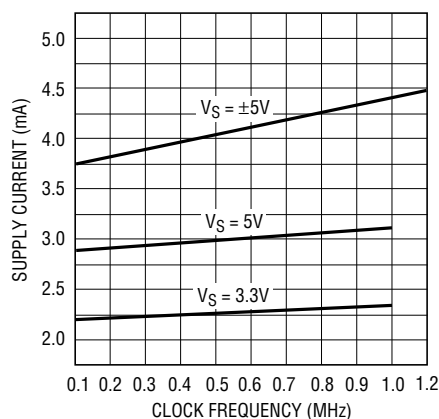

1069-1 G14

Output Voltage Swing vs Temperature

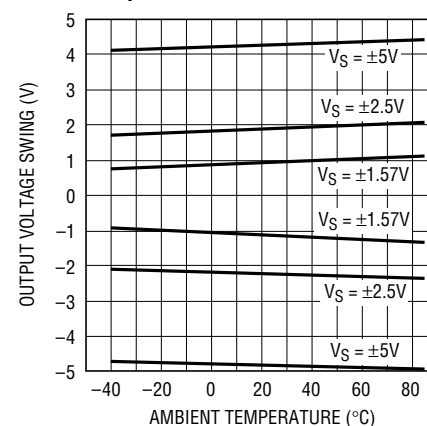

1069-1 G15

PIN FUNCTIONS

AGND (Pin 1): Analog Ground. The quality of the analog signal ground can affect the filter performance. For either single or dual supply operation, an analog ground plane surrounding the package is recommended. The analog ground plane should be connected to any digital ground at a single point. For dual supply operation Pin 1 should be connected to the analog ground plane.

For single supply operation Pin 1 should be bypassed to the analog ground plane with a $0.47\mu\text{F}$ or larger capacitor. An internal resistive divider biases Pin 1 to 1/2 the total power supply. Pin 1 should be buffered if used to bias other ICs. Figure 1 shows the connections for single supply operation.

V⁺, V⁻ (Pins 2, 7): Power Supply Pins. The V⁺ (Pin 2) and the V⁻ (Pin 7) should be bypassed with a $0.1\mu\text{F}$ capacitor to an adequate analog ground. The filter's power supplies should be isolated from other digital or high voltage analog supplies. A low noise linear supply is recommended. Using switching power supplies will lower the signal-to-noise ratio of the filter. Unlike previous monolithic filters, the power supplies can be applied at any order, that is, the positive supply can be applied before the negative supply and vice versa. Figure 2 shows the connection for dual supply operation.

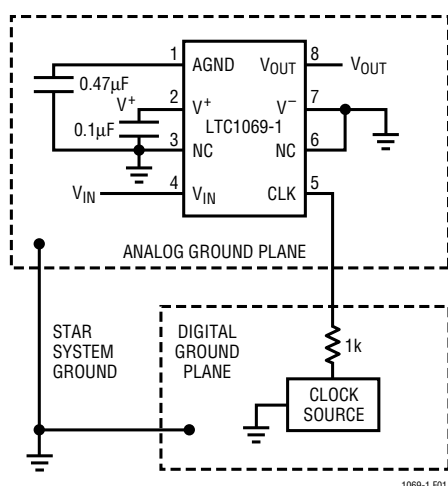

1069-1 F01

Figure 1. Connections for Single Supply Operation

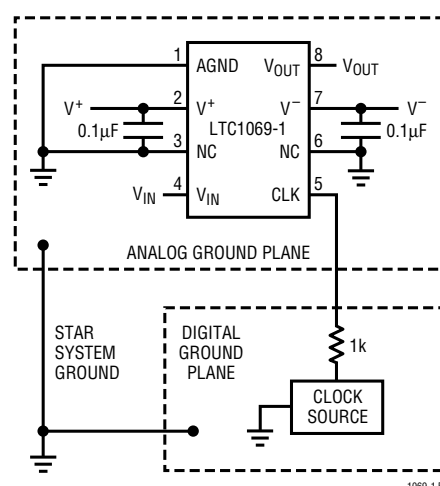

1069-1 F02

Figure 2. Connections for Dual Supply Operation

PIN FUNCTIONS

NC (Pins 3, 6): No Connection. Pins 3 and 6 are not connected to any internal circuitry; they should be preferably tied to ground.

V_{IN} (Pin 4): Filter Input Pin. The filter input pin is internally connected to the inverting input of an op amp through a 43k resistor.

CLK (Pin 5): Clock Input Pin. Any TTL or CMOS clock source with a square wave output and 50% duty cycle ($\pm 10\%$) is an adequate clock source for the device. The power supply for the clock source should not necessarily be the filter's power supply. The analog ground of the filter should be connected to clock's ground at a single point only. Table 1 shows the clock's low and high level threshold value for a dual or a single supply operation. A pulse generator can be used as a clock source provided the high level ON time is greater than $0.42\mu\text{s}$ ($V_S = \pm 5\text{V}$). Sine waves less than 100kHz are not recommended for clock signal because excessive slow clock rise or fall times generate internal clock jitter. The maximum clock rise or

fall is $1\mu\text{s}$. The clock signal should be routed from the right side of the IC package to avoid coupling into any input or output analog signal path. A 1k resistor between the clock source and the clock input pin (5) will slow down the rise and fall times of the clock to further reduce charge coupling, Figure 1.

Table 1. Clock Source High and Low Thresholds

POWER SUPPLY	HIGH LEVEL	LOW LEVEL
Dual Supply = $\pm 5\text{V}$	1.5V	0.5V
Single Supply = 10V	6.5V	5.5V
Single Supply = 5V	1.5V	0.5V
Single Supply = 3.3V	1.2V	0.5V

V_{OUT} (Pin 8): Filter Output Pin. Pin 8 is the output of the filter and it can source or sink 1mA. Driving coaxial cables or resistive loads less than 20k will degrade the total harmonic distortion of the filter. When evaluating the device's dynamic range, a buffer is required to isolate the filter's output from coax cables and instruments.

APPLICATIONS INFORMATION

Temperature Behavior

The power supply current of the LTC1069-1 has a positive temperature coefficient. The GBW product of its internal op amps is nearly constant and the speed of the device does not degrade at high temperatures. Figures 3a, 3b and 3c show the behavior of the maximum passband of the device for various supplies and temperatures. The filter,

especially at $\pm 5\text{V}$ supply, has a passband behavior which is nearly temperature independent.

Clock Feedthrough

The clock feedthrough is defined as the RMS value of the clock frequency and its harmonics that are present at the filter's output pin (8). The clock feedthrough is tested with

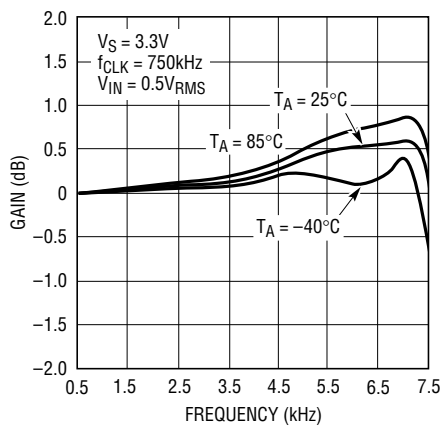

Figure 3a

1069-1 F03a

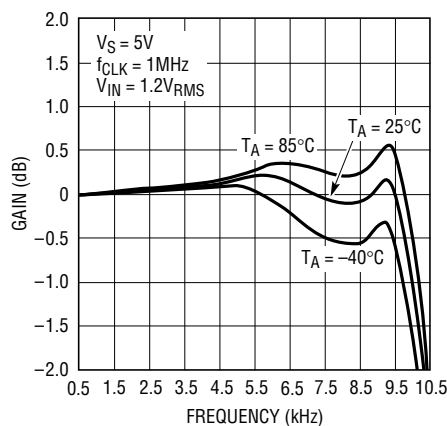

Figure 3b

1069-1 F03b

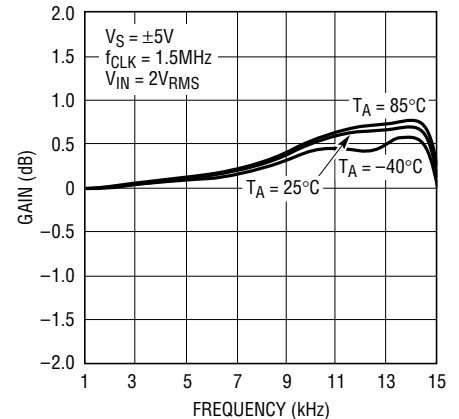
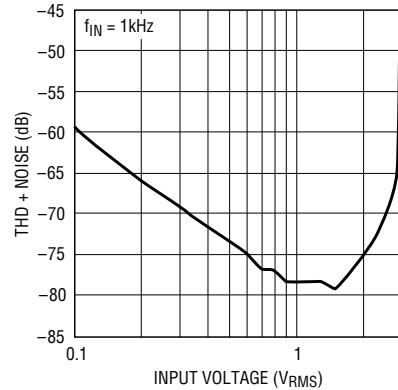
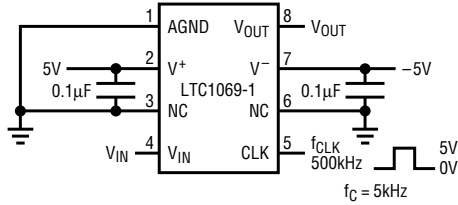

Figure 3c

1069-1 F03c

TYPICAL APPLICATIONS

Dual Supply Operation



1069-1 TA03

PACKAGE DESCRIPTION Dimensions in inches (millimeters) unless otherwise noted.

**N8 Package
8-Lead PDIP (Narrow 0.300)**
(LTC DWG # 05-08-1510)

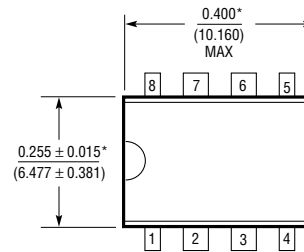
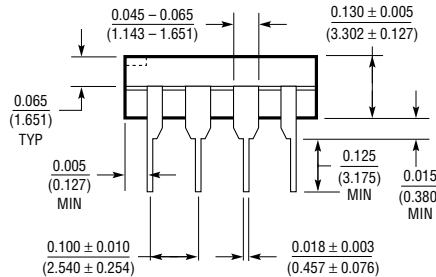
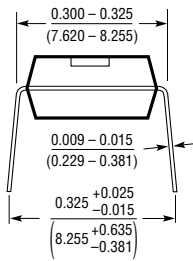

N8 0656

*THESE DIMENSIONS DO NOT INCLUDE MOLD FLASH OR PROTRUSIONS.
MOLD FLASH OR PROTRUSIONS SHALL NOT EXCEED 0.010 INCH (0.254mm)

**S8 Package
8-Lead Plastic Small Outline (Narrow 0.150)**
(LTC DWG # 05-08-1610)

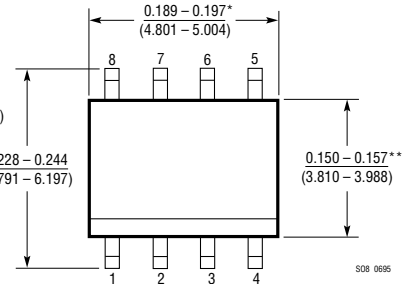
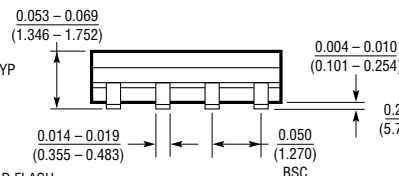
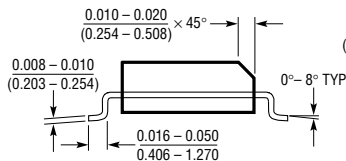

S08 0695

* DIMENSION DOES NOT INCLUDE MOLD FLASH. MOLD FLASH SHALL NOT EXCEED 0.006" (0.152mm) PER SIDE
** DIMENSION DOES NOT INCLUDE INTERLEAD FLASH. INTERLEAD FLASH SHALL NOT EXCEED 0.010" (0.254mm) PER SIDE

RELATED PARTS

PART NUMBER	DESCRIPTION	COMMENTS
LTC1068	Very Low Noise, High Accuracy, Quad Universal Filter Building Block	User-Configurable, SSOP Package
LTC1069-6	Single Supply, Very Low Power, Elliptic LPF	50:1 f_{CLK}/f_C Ratio, 8-Pin SO Package
LTC1164-5	Low Power 8th Order Butterworth LPF	100:1 and 50:1 f_{CLK}/f_C Ratio
LTC1164-6	Low Power 8th Order Elliptic LPF	100:1 and 50:1 f_{CLK}/f_C Ratio
LTC1164-7	Low Power 8th Order Linear Phase LPF	100:1 and 50:1 f_{CLK}/f_C Ratio

This datasheet has been downloaded from:

www.DatasheetCatalog.com

Datasheets for electronic components.