

**POW-R-BLOK™**  
**Dual SCR Isolated Module**  
**430 Amperes / 1800-2200 Volts**

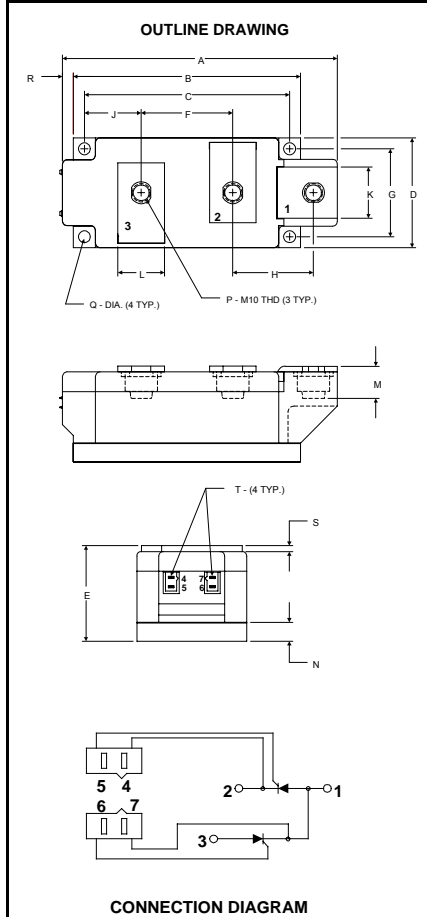

**LD43\_43**  
**Dual SCR**  
**POW-R-BLOK™ Module**  
**430 Amperes / 1800-2200 Volts**

**LD43 Outline Dimensions**

Dimension	Inches	Millimeters
A	5.91	150.0
B	4.88	124.0
C	4.41	112.0
D	2.36	60.0
E	2.05	52.0
F	1.97	50.0
G	1.89	48.0
H	1.73	44.0
J	1.22	31.0
K	1.10	28.0
L	1.00	25.4
M	0.69	17.5
N	0.39	10.0
P	M10 Metric	M10
Q	0.26 Dia.	6.5 Dia.
R	0.24	6.0
S	0.12	3.0
T	.110 x .032	2.5 x 0.8

Note: Dimensions are for reference only.

**Ordering Information:**

Select the complete eight-digit module part number from the table below.

Example: LD431843 is a 1800 Volt, 430 Ampere Dual SCR Isolated POW-R-BLOK™ Module

Type	Voltage Volts (x100)	Current Amperes (x10)
LD43	18	43
	20	
	22	

**Description:**

Powerex Dual SCR Modules are designed for use in applications requiring phase control and isolated packaging. The modules are isolated for easy mounting with other components on a common heatsink. POW-R-BLOK™ has been tested and recognized by the Underwriters Laboratories.

**Features:**

- Electrically Isolated Heatsinking
- Aluminum Nitride Isolator
- Compression Bonded Elements
- Metal Baseplate
- Low Thermal Impedance for Improved Current Capability
- UL Recognized

**Benefits:**

- No Additional Insulation Components Required
- Easy Installation
- No Clamping Components Required
- Reduce Engineering Time

**Applications:**

- Bridge Circuits
- AC & DC Motor Drives
- Battery Supplies
- Power Supplies
- Large IGBT Circuit Front Ends

**Absolute Maximum Ratings**

Characteristics	Conditions	Symbol	Units
Repetitive Peak Forward and Reverse Blocking Voltage		$V_{DRM}$ & $V_{RRM}$	up to 2200 V
Non-Repetitive Peak Blocking Voltage ( $t < 5$ msec)		$V_{RSM}$	$V_{RRM} + 100$ V
RMS Forward Current	$T_C=70^\circ\text{C}$	$I_{T(RMS)}$	800 A
Average Forward Current	180° Conduction, $T_C=80^\circ\text{C}$	$I_{T(AV)}$	430 A
	180° Conduction, $T_C=70^\circ\text{C}$	$I_{T(AV)}$	510 A
Peak One Cycle Surge Current, Non-Repetitive	60 Hz, 100% $V_{RRM}$ reapplied, $T_j=25^\circ\text{C}$	$I_{TSM}$	14,000 A
	60 Hz, No $V_{RRM}$ reapplied, $T_j=25^\circ\text{C}$	$I_{TSM}$	16,000 A
	60 Hz, 100% $V_{RRM}$ reapplied, $T_j=125^\circ\text{C}$	$I_{TSM}$	12,000 A
	60 Hz, No $V_{RRM}$ reapplied, $T_j=125^\circ\text{C}$	$I_{TSM}$	14,000 A
	50 Hz, 100% $V_{RRM}$ reapplied, $T_j=25^\circ\text{C}$	$I_{TSM}$	12,000 A
	50 Hz, No $V_{RRM}$ reapplied, $T_j=25^\circ\text{C}$	$I_{TSM}$	14,000 A
	50 Hz, 100% $V_{RRM}$ reapplied, $T_j=125^\circ\text{C}$	$I_{TSM}$	10,000 A
	50 Hz, No $V_{RRM}$ reapplied, $T_j=125^\circ\text{C}$	$I_{TSM}$	12,000 A
Peak Three Cycle Surge Current, Non-Repetitive	60 Hz, 100% $V_{RRM}$ reapplied, $T_j=125^\circ\text{C}$	$I_{TSM}$	8,600 A
Peak Ten Cycle Surge Current, Non-Repetitive	60 Hz, 100% $V_{RRM}$ reapplied, $T_j=125^\circ\text{C}$	$I_{TSM}$	7,500 A
$I^2t$ for Fusing for One Cycle	8.3 milliseconds, $T_j=25^\circ\text{C}$	$I^2t$	$1.07 \times 10^6$ A <sup>2</sup> sec
	8.3 milliseconds, $T_j=125^\circ\text{C}$	$I^2t$	$0.82 \times 10^6$ A <sup>2</sup> sec
	10 milliseconds, $T_j=25^\circ\text{C}$	$I^2t$	$0.98 \times 10^6$ A <sup>2</sup> sec
	10 milliseconds, $T_j=125^\circ\text{C}$	$I^2t$	$0.72 \times 10^6$ A <sup>2</sup> sec
Maximum Rate-of-Rise of On-State Current, (Repetitive)	Per JEDEC Standard 397 5.2.2.6	$di/dt$	200 A/ $\mu$ s
Operating Temperature		$T_J$	-40 to +125 °C
Storage Temperature		$T_{stg}$	-40 to +150 °C
Max. Mounting Torque, M6 Mounting Screw			55 in. – Lb.
			6 Nm
Max. Mounting Torque, M10 Terminal Screw			110 in. – Lb.
			12 Nm
Module Weight, Typical			1500 g
			3.30 lb
V Isolation @ 25C		$V_{rms}$	3000 V

**Electrical Characteristics, T<sub>J</sub>=25°C unless otherwise specified**

Characteristics	Symbol	Test Conditions	Min.	Max.	Units
Repetitive Peak Forward Leakage Current	I <sub>DRM</sub>	Up to 2200V, T <sub>J</sub> =125°C		80	mA
Repetitive Peak Reverse Leakage Current	I <sub>RRM</sub>	Up to 2200V, T <sub>J</sub> =125°C		80	mA
Peak On-State Voltage	V <sub>TM</sub>	I <sub>TM</sub> =1500A		1.77	V
Threshold Voltage, Low-level	V <sub>(TO)1</sub>	T <sub>J</sub> = 125°C, I = 15%I <sub>T(AV)</sub> to πI <sub>T(AV)</sub>		0.88	V
Slope Resistance, Low-level	r <sub>T1</sub>	V <sub>TM</sub> = V <sub>(TO)1</sub> + r <sub>T1</sub> I		0.66	mΩ
Threshold Voltage, High-level	V <sub>(TO)2</sub>	T <sub>J</sub> = 125°C, I = πI <sub>T(AV)</sub> to I <sub>TSM</sub>		1.34	V
Slope Resistance, High-level	r <sub>T2</sub>	V <sub>TM</sub> = V <sub>(TO)2</sub> + r <sub>T2</sub> I		0.32	mΩ
V <sub>TM</sub> Coefficients, Full Range		T <sub>J</sub> = 125°C, I = 10A to 6kA V <sub>TM</sub> = A+ B Ln I + C I + D Sqrt I	A = B = C = D =	0.766 -1.046E-02 1.805E-04 2.00E-02	
Minimum dV/dt	dV/dt	Exponential to V <sub>DRM</sub> T <sub>J</sub> =125°C, Gate Open	1000 Typ.		V/μs
Gate Trigger Current	I <sub>GT</sub>	T <sub>J</sub> =25°C, V <sub>D</sub> =12V		200	mA
Gate Trigger Voltage	V <sub>GT</sub>	T <sub>J</sub> =25°C, V <sub>D</sub> =12V		3.0	Volts
Non-Triggering Gate Voltage	V <sub>GDM</sub>	T <sub>J</sub> =125°C, V <sub>D</sub> = ½ V <sub>DRM</sub>		0.25	Volts
Peak Forward Gate Current	I <sub>GTM</sub>			4.0	Amp
Peak Reverse Gate Voltage	V <sub>GRM</sub>			5	Volts

**Thermal Characteristics**

Characteristics	Symbol		Max.	Units
Thermal Resistance, Junction to Case	R <sub>ΘJ-C</sub>	Per Module, both conducting Per Junction, both conducting	0.0325 0.0650	°C/W °C/W
Thermal Impedance Coefficients	Z <sub>ΘJ-C</sub>	Z <sub>ΘJ-C</sub> = K <sub>1</sub> (1-exp(-t/τ <sub>1</sub> )) + K <sub>2</sub> (1-exp(-t/τ <sub>2</sub> )) + K <sub>3</sub> (1-exp(-t/τ <sub>3</sub> )) + K <sub>4</sub> (1-exp(-t/τ <sub>4</sub> ))	K <sub>1</sub> = 8.03E-04 K <sub>2</sub> = 1.03E-02 K <sub>3</sub> = 1.64E-02 K <sub>4</sub> = 3.75E-02	τ <sub>1</sub> = 3.39E-04 τ <sub>2</sub> = 3.15E-03 τ <sub>3</sub> = 0.106 τ <sub>4</sub> = 2.066
Thermal Resistance, Case to Sink Lubricated	R <sub>ΘC-S</sub>	Per Module	0.01	°C/W

**POW-R-BLOK™**  
**Dual SCR Isolated Module**  
**430 Amperes / 1800-2200 Volts**

**Maximum On-State Forward Voltage Drop**  
 (T<sub>j</sub> = 125 °C)

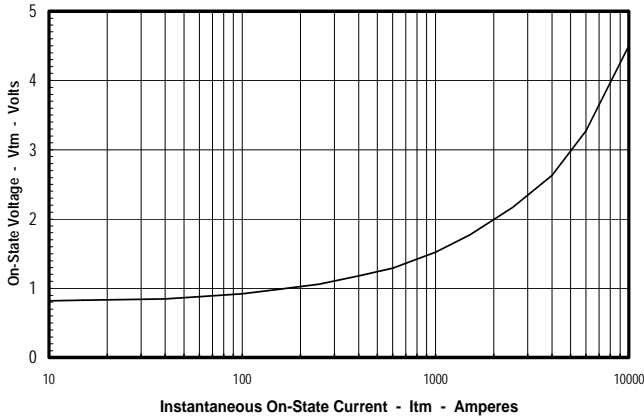

**Maximum Transient Thermal Impedance**  
 (Junction to Case)

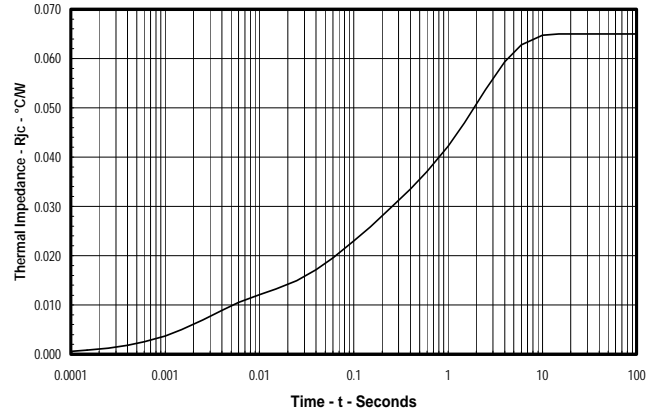

**Maximum On-State Power Dissipation**  
 (Sinusoidal Waveform)

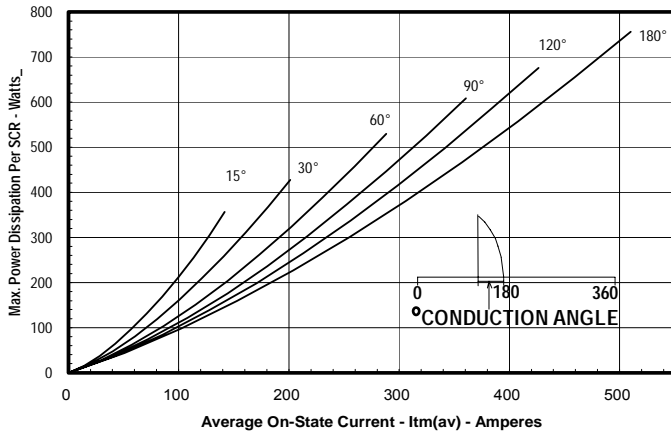

**Maximum Allowable Case Temperature**  
 (Sinusoidal Waveform)

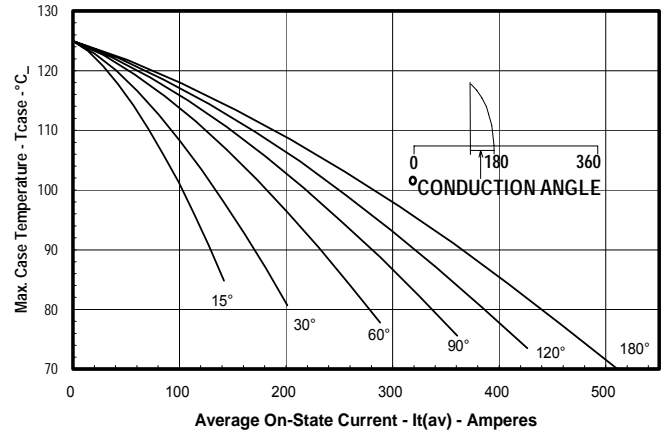

**Maximum On-State Power Dissipation**  
 (Rectangular Waveform)

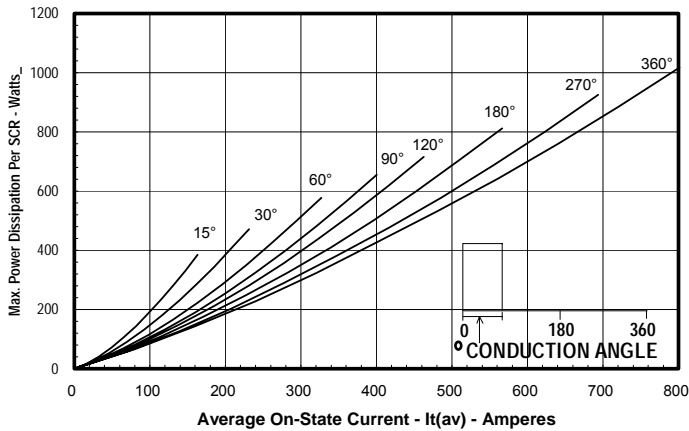

**Maximum Allowable Case Temperature**  
 (Rectangular Waveform)

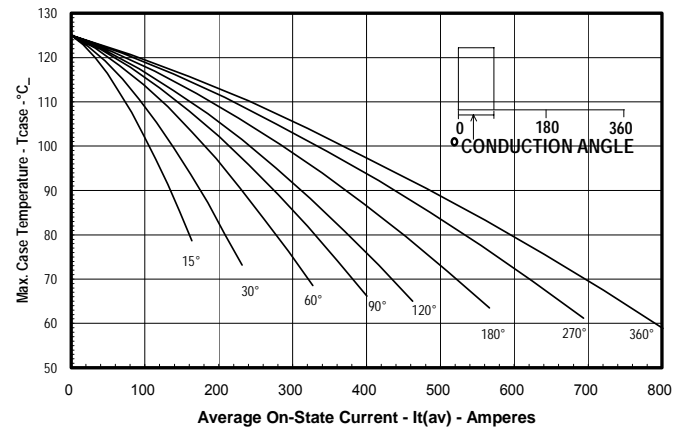

This datasheet has been download from:

[www.datasheetcatalog.com](http://www.datasheetcatalog.com)

Datasheets for electronics components.