



Integrated Device Technology, Inc.

# CMOS SyncFIFO™

512 x 36, 1024 x 36,  
2048 x 36

IDT723631  
IDT723641  
IDT723651

## FEATURES:

- Free-running CLKA and CLKB can be asynchronous or coincident (permits simultaneous reading and writing of data on a single clock edge)
- Clocked FIFO buffering data from Port A to Port B
- Storage capacity: IDT723631 - 512 x 36  
IDT723641 - 1024 x 36  
IDT723651 - 2048 x 36
- Synchronous read retransmit capability
- Mailbox register in each direction
- Programmable Almost-Full and Almost-Empty flags
- Microprocessor interface control logic
- Input-Ready (IR) and Almost-Full ( $\overline{AF}$ ) flags synchronized by CLKA
- Output-Ready (OR) and Almost-Empty ( $\overline{AE}$ ) flags synchronized by CLKB
- Low-power 0.8-micron advanced CMOS technology

- Supports clock frequencies up to 67 MHz
- Fast access times of 11 ns
- Available in 132-pin plastic quad flat package (PQF) or space-saving 120-pin thin quad flat package (TQFP)
- Industrial temperature range (-40°C to +85°C) is available, tested to military electrical specifications

## DESCRIPTION:

The IDT723631/723641/723651 is a monolithic high-speed, low-power, CMOS clocked FIFO memory. It supports clock frequencies up to 67 MHz and has read access times as fast as 12ns. The 512/1024/2048 x 36 dual-port SRAM FIFO buffers data from port A to Port B. The FIFO memory has retransmit capability, which allows previously read data to be accessed again. The FIFO has flags to indicate empty and full conditions and two programmable flags (almost full and almost empty) to indicate when a selected number of words is

## FUNCTIONAL BLOCK DIAGRAM

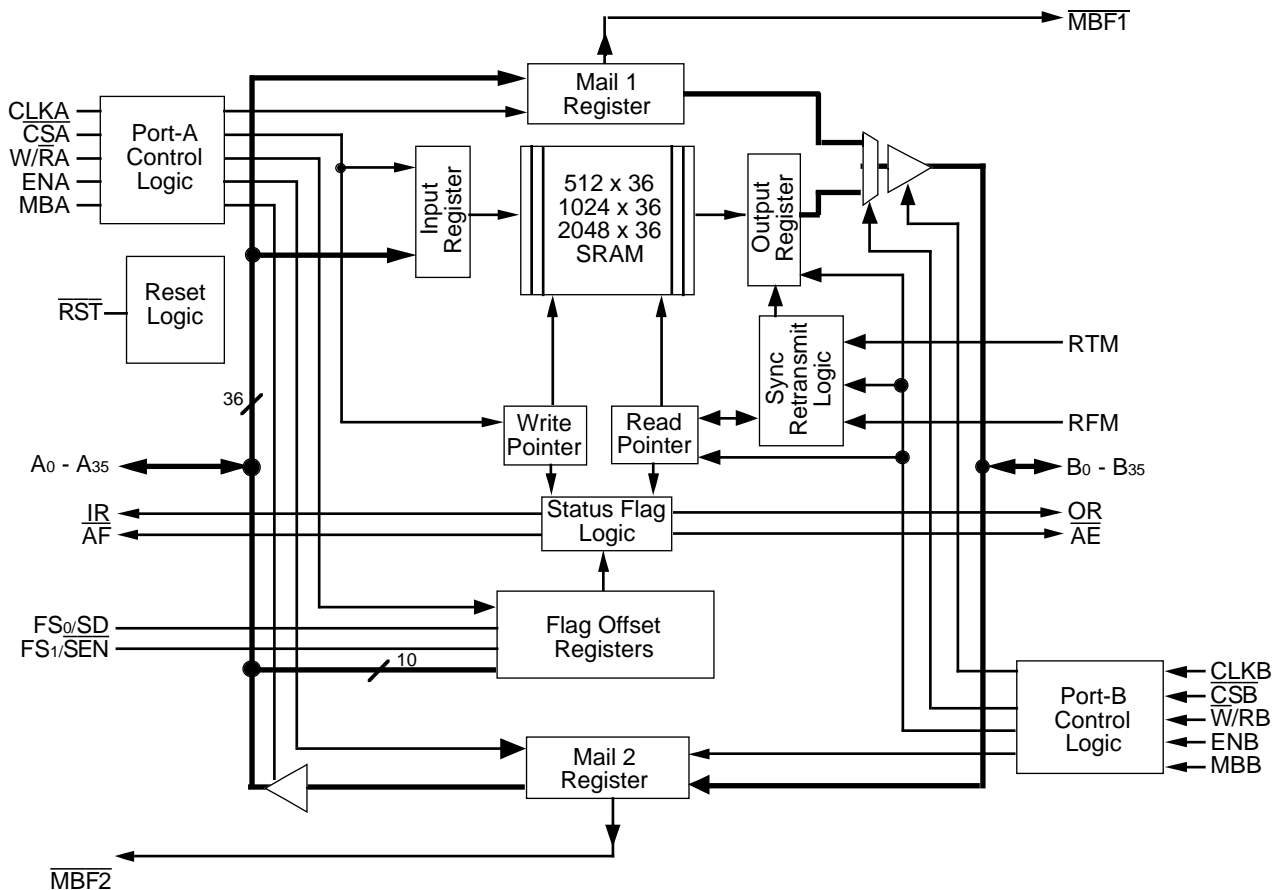

3023 drw 01

The IDT logo is a registered trademark and SyncFIFO is a trademark of Integrated Device Technology, Inc.

COMMERCIAL TEMPERATURE RANGE

MAY 1997

## DESCRIPTION (CONTINUED)

stored in memory. Communication between each port may take place with two 36-bit mailbox registers. Each mailbox register has a flag to signal when new mail has been stored. Two or more devices may be used in parallel to create wider data paths. Expansion is also possible in word depth.

The IDT723631/723641/723651 is a clocked FIFO, which means each port employs a synchronous interface. All data transfers through a port are gated to the LOW-to-HIGH transition of a continuous (free-running) port clock by enable signals. The continuous clocks for each port are independent

of one another and can be asynchronous or coincident. The enables for each port are arranged to provide a simple interface between microprocessors and/or buses with synchronous control.

The input-ready (IR) flag and almost-full ( $\overline{AF}$ ) flag of the FIFO are two-stage synchronized to CLK<sub>A</sub>. The output-ready (OR) flag and almost-empty ( $\overline{AE}$ ) flag of the FIFO are two-stage synchronized to CLK<sub>B</sub>. Offset values for the almost-full and almost empty flags of the FIFO can be programmed from port A or through a serial input.

## PIN CONFIGURATION

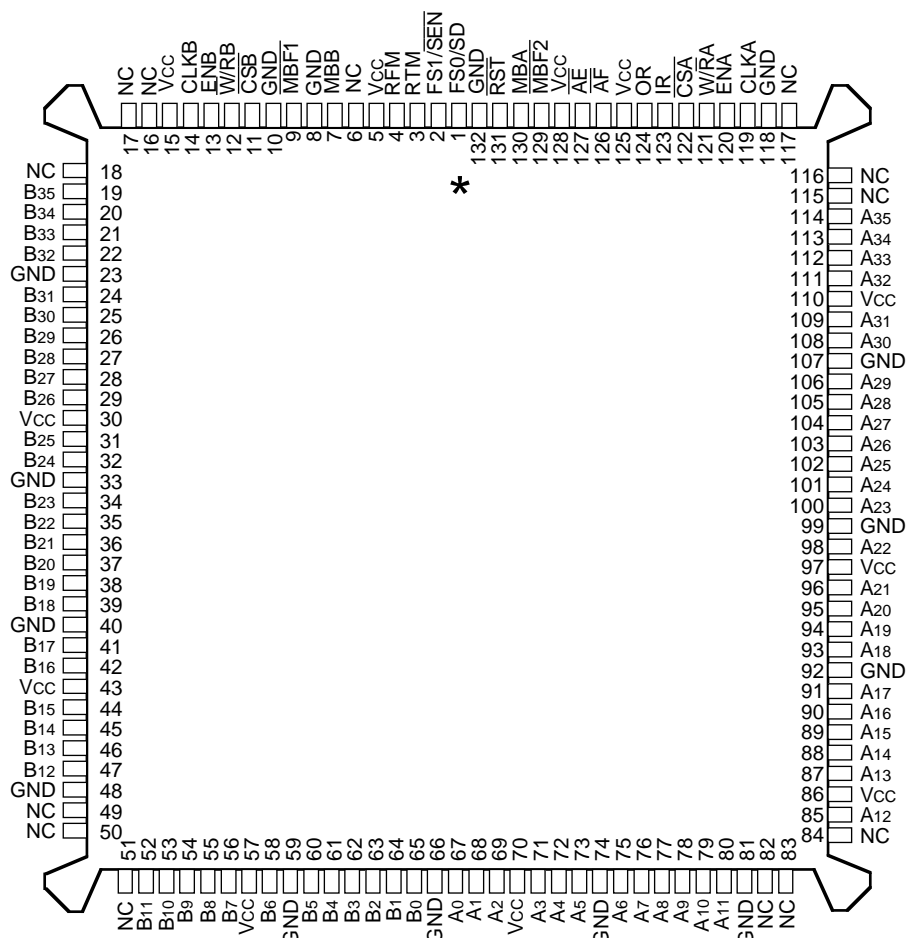

\* Electrical pin 1 in center of beveled edge. Pin 1 identifier in corner.

3023 drw 02

**PQFP (PQ132-1, order code: PQF)**  
**TOP VIEW**

### Notes:

1. NC – No internal connection
2. Uses Yamaichi socket IC51-1324-828



## PIN DESCRIPTION

Symbol	Name	I/O	Description
A0-A35	Port-A Data	I/O	36-bit bidirectional data port for side A.
$\overline{AE}$	Almost-Empty Flag	O	Programmable flag synchronized to CLKB. It is LOW when the number of words in the FIFO is less than or equal to the value in the almost-empty register (X).
$\overline{AF}$	Almost-Full Flag.	O	Programmable flag synchronized to CLKA. It is LOW when the number of empty locations in the FIFO is less than or equal to the value in the almost-full offset register (Y).
B0-B35	Port-B Data.	I/O	36-bit bidirectional data port for side B.
CLKA	Port-A Clock	I	CLKA is a continuous clock that synchronizes all data transfers through port-A and may be asynchronous or coincident to CLKB. IR and $\overline{AF}$ are synchronous to the LOW-to-HIGH transition of CLKA.
CLKB	Port-B Clock	I	CLKB is a continuous clock that synchronizes all data transfers through port-B and may be asynchronous or coincident to CLKA. OR and AE are synchronous to the LOW-to-HIGH transition of CLKB.
$\overline{CSA}$	Port-A Chip Select	I	$\overline{CSA}$ must be LOW to enable a LOW-to-HIGH transition of CLKA to read or write data on port-A. The A0-A35 outputs are in the high-impedance state when $\overline{CSA}$ is HIGH.
$\overline{CSB}$	Port-B Chip Select	I	$\overline{CSB}$ must be LOW to enable a LOW-to-HIGH transition of CLKB to read or write data on port-B. The B0-B35 outputs are in the high-impedance state when $\overline{CSB}$ is HIGH.
ENA	Port-A Enable	I	ENA must be HIGH to enable a LOW-to-HIGH transition of CLKA to read or write data on port-A.
ENB	Port-B Enable	I	ENB must be HIGH to enable a LOW-to-HIGH transition of CLKB to read or write data on port-B.
FS1/ $\overline{SEN}$ , FS0/SD	Flag-Offset Select 1/ Serial Enable, Flag Offset 0/ Serial Data	I	FS1/ $\overline{SEN}$ and FS0/SD are dual-purpose inputs used for flag offset register programming. During a device reset, FS1/ $\overline{SEN}$ and FS0/SD selects the flag offset programming method. Three offset register programming methods are available: automatically load one of two preset values, parallel load from port A, and serial load. When serial load is selected for flag offset register programming, FS1/ $\overline{SEN}$ is used as an enable synchronous to the LOW-to-HIGH transition of CLKA. When FS1/ $\overline{SEN}$ is LOW, a rising edge on CLKA load the bit present on FS0/SD into the X and Y registers. The number of bit writes required to program the offset registers is 18/20/22. The first bit write stores the Y-register MSB and the last bit write stores the X-register LSB.
IR	Input-Ready Flag	O	IR is synchronized to the LOW-to-HIGH transition of CLKA. When IR is LOW, the FIFO is full and writes to its array are disabled. When the FIFO is in retransmit mode, IR indicates when the memory has been filled to the point of the retransmit data and prevents further writes. IR is set LOW during reset and is set HIGH after reset.
MBA	Port-A Mailbox Select	I	A HIGH level chooses a mailbox register for a port-A read or write operation.
MBB	Port-B Mailbox Select	I	A HIGH level chooses a mailbox register for a port-B read or write operation. When the B0-B35 outputs are active, a HIGH level on MBB selects data from the mail1 register for output and a LOW level selects FIFO data for output.
$\overline{MBF1}$	Mail1 Register Flag	O	$\overline{MBF1}$ is set LOW by the LOW-to-HIGH transition of CLKA that writes data to the mail1 register. $\overline{MBF1}$ is set HIGH by a LOW-to-HIGH transition of CLKB when a port-B read is selected and MBB is HIGH. $\overline{MBF1}$ is set HIGH by a reset.

3023 tbl 01

## PIN DESCRIPTION (CONTINUED)

Symbol	Name	I/O	Description
$\overline{\text{MBF2}}$	Mail2 Register Flag	O	$\overline{\text{MBF2}}$ is set LOW by the LOW-to-HIGH transition of CLKB that writes data to the mail2 register. $\overline{\text{MBF2}}$ is set HIGH by a LOW-to-HIGH transition of CLKA when a port-A read is selected and MBA is HIGH. $\overline{\text{MBF2}}$ is set HIGH by a reset.
OR	Output-Ready Flag	O	OR is synchronized to the LOW-to-HIGH transition of CLKB. When OR is LOW, the FIFO is empty and reads are disabled. Ready data is present in the output register of the FIFO when OR is HIGH. OR is forced LOW during the reset and goes HIGH on the third LOW-to-HIGH transition of CLKB after a word is loaded to empty memory.
RFM	Read From Mark	I	When the FIFO is in retransmit mode, a HIGH on RFM enables a LOW-to-HIGH transition of CLKB to reset the read pointer to the beginning retransmit location and output the first selected retransmit data.
$\overline{\text{RST}}$	Reset	I	To reset the device, four LOW-to-HIGH transitions of CLKA and four LOW-to-HIGH transitions of CLKB must occur while $\overline{\text{RST}}$ is LOW. The LOW-to-HIGH transition of $\overline{\text{RST}}$ latches the status of FS0 and FS1 for $\overline{\text{AF}}$ and $\overline{\text{AE}}$ offset selection.
RTM	Retransmit Mode	I	When RTM is HIGH and valid data is present in the FIFO output register (OR is HIGH), a LOW-to-HIGH transition of CLKB selects the data for the beginning of a retransmit and puts the FIFO in retransmit mode. The selected word remains the initial retransmit point until a LOW-to-HIGH transition of CLKB occurs while RTM is LOW, taking the FIFO out of retransmit mode.
$\overline{\text{W/RA}}$	Port-A Write/Read Select	I	A HIGH selects a write operation and a LOW selects a read operation on port A for a LOW-to-HIGH transition of CLKA. The A0-A35 outputs are in the high-impedance state when $\overline{\text{W/RA}}$ is HIGH.
$\overline{\text{W/RB}}$	Port-B Write/Read Select	I	A LOW selects a write operation and a HIGH selects a read operation on port B for a LOW-to-HIGH transition of CLKB. The B0-B35 outputs are in the high-impedance state when $\overline{\text{W/RB}}$ is LOW.

3023 tbi 02

## ABSOLUTE MAXIMUM RATINGS OVER OPERATING FREE-AIR TEMPERATURE RANGE (UNLESS OTHERWISE NOTED)<sup>(2)</sup>

Symbol	Rating	Commercial	Unit
V <sub>CC</sub>	Supply Voltage Range	-0.5 to 7	V
V <sub>I</sub> <sup>(2)</sup>	Input Voltage Range	-0.5 to V <sub>CC</sub> +0.5	V
V <sub>O</sub> <sup>(2)</sup>	Output Voltage Range	-0.5 to V <sub>CC</sub> +0.5	V
I <sub>IK</sub>	Input Clamp Current, (V <sub>I</sub> < 0 or V <sub>I</sub> > V <sub>CC</sub> )	±20	mA
I <sub>OK</sub>	Output Clamp Current, (V <sub>O</sub> = < 0 or V <sub>O</sub> > V <sub>CC</sub> )	±50	mA
I <sub>OUT</sub>	Continuous Output Current, (V <sub>O</sub> = 0 to V <sub>CC</sub> )	±50	mA
I <sub>CC</sub>	Continuous Current Through V <sub>CC</sub> or GND	±400	mA
T <sub>A</sub>	Operating Free Air Temperature Range	0 to 70	°C
T <sub>STG</sub>	Storage Temperature Range	-65 to 150	°C

3023 tbl 03

### NOTES:

- Stresses beyond those listed under "Absolute Maximum Ratings" may cause permanent damage to the device. These are stress ratings only and functional operation of the device at these or any other conditions beyond those indicated under "Recommended Operating Conditions" is not implied. Exposure to absolute-maximum-rated conditions for extended periods may affect device reliability.
- The input and output voltage ratings may be exceeded provided the input and output current ratings are observed.

## RECOMMENDED OPERATING CONDITIONS

Symbol	Parameter	Min.	Max.	Unit
V <sub>CC</sub>	Supply Voltage	4.5	5.5	V
V <sub>IH</sub>	HIGH Level Input Voltage	2	–	V
V <sub>IL</sub>	LOW-Level Input Voltage	–	0.8	V
I <sub>OH</sub>	HIGH-Level Output Current	–	-4	mA
I <sub>OL</sub>	LOW-Level Output Current	–	8	mA
T <sub>A</sub>	Operating Free-air Temperature	0	70	°C

3023 tbl 04

## ELECTRICAL CHARACTERISTICS OVER RECOMMENDED OPERATING FREE-AIR TEMPERATURE RANGE (UNLESS OTHERWISE NOTED)

Parameter	Test Conditions		Min.	Typ. <sup>(1)</sup>	Max.	Unit
V <sub>OH</sub>	V <sub>CC</sub> = 4.5V,	I <sub>OH</sub> = -4 mA	2.4			V
V <sub>OL</sub>	V <sub>CC</sub> = 4.5 V,	I <sub>OL</sub> = 8 mA			0.5	V
I <sub>LI</sub>	V <sub>CC</sub> = 5.5 V,	V <sub>I</sub> = V <sub>CC</sub> or 0			±5	μA
I <sub>LO</sub>	V <sub>CC</sub> = 5.5 V,	V <sub>O</sub> = V <sub>CC</sub> or 0			±5	μA
I <sub>CC</sub>	V <sub>CC</sub> = 5.5 V,	V <sub>I</sub> = V <sub>CC</sub> -0.2 V or 0			400	μA
ΔI <sub>CC</sub> <sup>(2)</sup>	V <sub>CC</sub> = 5.5 V, One Input at 3.4 V, Other Inputs at V <sub>CC</sub> or GND	$\overline{CSA} = V_{IH}$	A0-A35	0		mA
		$\overline{CSB} = V_{IH}$	B0-B35	0		
		$\overline{CSA} = V_{IL}$	A0-A35		1	
		$\overline{CSB} = V_{IL}$	B0-35		1	
		All Other Inputs			1	
C <sub>IN</sub>	V <sub>I</sub> = 0,	f = 1 MHz		4		pF
C <sub>OUT</sub>	V <sub>O</sub> = 0,	f = 1 MHz		8		pF

3023 tbl 05

### NOTES:

- All typical values are at V<sub>CC</sub> = 5 V, T<sub>A</sub> = 25°C.
- This is the supply current when each input is at least one of the specified TTL voltage levels rather than 0 V or V<sub>CC</sub>.

## AC ELECTRICAL CHARACTERISTICS OVER RECOMMENDED RANGES OF SUPPLY VOLTAGE AND OPERATING FREE-AIR TEMPERATURE

Symbol	Parameter	IDT723631L15		IDT723631L20		IDT723631L30		Unit
		IDT723641L15		IDT723641L20		IDT723641L30		
		IDT723651L15		IDT723651L20		IDT723651L30		
		Min.	Max.	Min.	Max.	Min.	Max.	
fs	Clock Frequency, CLKA or CLKB	–	66.7	–	50	–	33.4	MHz
tCLK	Clock Cycle Time, CLKA or CLKB	15	–	20	–	30	–	ns
tCLKH	Pulse Duration, CLKA or CLKB HIGH	6	–	8	–	12	–	ns
tCLKL	Pulse Duration, CLKA or CLKB LOW	6	–	8	–	12	–	ns
tDS	Setup Time, A0-A35 before CLKA↑ and B0-B35 before CLKB↑	5	–	6	–	7	–	ns
tENS1	Setup Time, ENA to CLKA↑; ENB to CLKB↑	5	–	6	–	7	–	ns
tENS2	Setup Time, $\overline{CSA}$ , $\overline{W/RA}$ , and MBA to CLKA↑; $\overline{CSB}$ , $\overline{W/RB}$ , and MBB to CLKB↑	7	–	7.5	–	8	–	ns
tRMS	Setup Time, RTM and RFM to CLKB↑	6	–	6.5	–	7	–	ns
tRSTS	Setup Time, $\overline{RST}$ LOW before CLKA↑ or CLKB↑ <sup>(1)</sup>	5	–	6	–	7	–	ns
tFSS	Setup Time, FS0 and FS1 before $\overline{RST}$ HIGH	9	–	10	–	11	–	ns
tSDS <sup>(2)</sup>	Setup Time, FS0/SD before CLKA↑	5	–	6	–	7	–	ns
tSENS <sup>(2)</sup>	Setup Time, FS1/ $\overline{SEN}$ before CLKA↑	5	–	6	–	7	–	ns
tDH	Hold Time, A0-A35 after CLKA↑ and B0-B35 after CLKB↑	0	–	0	–	0	–	ns
tENH1	Hold Time, ENA after CLKA↑; ENB after CLKB↑	0	–	0	–	0	–	ns
tENH2	Hold Time, $\overline{CSA}$ , $\overline{W/RA}$ , and MBA after CLKA↑; $\overline{CSB}$ , $\overline{W/RB}$ , and MBB after CLKB↑	0	–	0	–	0	–	ns
tRMH	Hold Time, RTM and RFM after CLKB↑	0	–	0	–	0	–	ns
tRSTH	Hold Time, $\overline{RST}$ LOW after CLKA↑ or CLKB↑ <sup>(1)</sup>	5	–	6	–	7	–	ns
tFSH	Hold Time, FS0 and FS1 after $\overline{RST}$ HIGH	0	–	0	–	0	–	ns
tSPH <sup>(2)</sup>	Hold Time, FS1/ $\overline{SEN}$ HIGH after $\overline{RST}$ HIGH	0	–	0	–	0	–	ns
tSDH <sup>(2)</sup>	Hold Time, FS0/SD after CLKA↑	0	–	0	–	0	–	ns
tSENH <sup>(2)</sup>	Hold Time, FS1/ $\overline{SEN}$ after CLKA↑	0	–	0	–	0	–	ns
tSKEW1 <sup>(3)</sup>	Skew Time, between CLKA↑ and CLKB↑ for OR and IR	9	–	11	–	13	–	ns
tSKEW2 <sup>(3)</sup>	Skew Time, between CLKA↑ and CLKB↑ for $\overline{AE}$ and $\overline{AF}$	12	–	16	–	20	–	ns

3023 tbl 06

### NOTES:

1. Requirement to count the clock edge as one of at least four needed to reset a FIFO.
2. Only applies when serial load method is used to program flag offset registers.
3. Skew time is not a timing constraint for proper device operation and is only included to illustrate the timing relationship between CLKA cycle and CLKB cycle.

## AC ELECTRICAL CHARACTERISTICS

Symbol	Parameter	IDT723631L15		IDT723631L20		IDT723631L30		Unit
		Min.	Max.	Min.	Max.	Min.	Max.	
fs	Clock Frequency, CLKA or CLKB	–	66.7	–	50	–	33.4	MHz
tA	Access Time, CLKB↑ to B0-B35	3	11	3	13	3	15	ns
tPIR	Propagation Delay Time, CLKA↑ to IR	1	8	1	10	1	12	ns
tPOR	Propagation Delay Time, CLKB↑ to OR	1	8	1	10	1	12	ns
tPAE	Propagation Delay Time, CLKB↑ to $\overline{AE}$	1	8	1	10	1	12	ns
tPAF	Propagation Delay Time, CLKA↑ to $\overline{AF}$	1	8	1	10	1	12	ns
tPMF	Propagation Delay Time, CLKA↑ to $\overline{MBF1}$ LOW or $\overline{MBF2}$ HIGH and CLKB↑ to $\overline{MBF2}$ LOW or $\overline{MBF1}$ HIGH	0	8	0	10	0	12	ns
tPMR	Propagation Delay Time, CLKA↑ to B0-B35 <sup>(1)</sup> and CLKB↑ to A0-A35 <sup>(2)</sup>	3	13.5	3	15	3	17	ns
tMDV	Propagation Delay Time, MBB to B0-B35 Valid	3	13	3	15	3	17	ns
tRSF	Propagation Delay Time, $\overline{RST}$ LOW to $\overline{AE}$ LOW and $\overline{AF}$ HIGH	1	15	1	20	1	30	ns
tEN	Enable Time, $\overline{CSA}$ and $\overline{W/RA}$ LOW to A0-A35 Active and $\overline{CSB}$ LOW and $\overline{W/RB}$ HIGH to B0-B35 Active	2	12	2	13	2	14	ns
tDIS	Disable Time, $\overline{CSA}$ or $\overline{W/RA}$ HIGH to A0-A35 at high impedance and $\overline{CSB}$ HIGH or $\overline{W/RB}$ LOW to B0-B35 at high impedance	1	8	1	10	1	11	ns

3023 tbl 07

### NOTES:

1. Writing data to the mail1 register when the B0-B35 outputs are active and MBB is HIGH.
2. Writing data to the mail2 register when the A0-A35 outputs are active and MBA is HIGH.



## SIGNAL DESCRIPTION

### RESET

The IDT723631/723641/723651 is reset by taking the reset ( $\overline{RST}$ ) input LOW for at least four port-A clock (CLKA) and four port-B (CLKB) LOW-to-HIGH transitions. The reset input may switch asynchronously to the clocks. A reset initializes the memory read and write pointers and forces the input-ready (IR) flag LOW, the output-ready (OR) flag LOW, the almost-empty ( $\overline{AE}$ ) flag LOW, and the almost-full ( $\overline{AF}$ ) flag HIGH. Resetting the device also forces the mailbox flags ( $\overline{MBF1}$ ,  $\overline{MBF2}$ ) HIGH. After a FIFO is reset, its input-ready flag is set HIGH after at least two clock cycles to begin normal operation. A FIFO must be reset after power up before data is written to its memory.

### ALMOST-EMPTY FLAG AND ALMOST-FULL FLAG OFFSET PROGRAMMING

Two registers in the IDT723631/723641/723651 are used to hold the offset values for the almost-empty and almost full flags. The almost-empty ( $\overline{AE}$ ) flag offset register is labeled X, and the almost-full ( $\overline{AF}$ ) flag offset register is labeled Y. The offset register can be loaded with a value in three ways: one of two preset values are loaded into the offset registers, parallel load from port A, or serial load. The offset register programming mode is chosen by the flag select (FS1, FS0) inputs during a LOW-to-HIGH transition on the  $\overline{RST}$  input (See Table 1).

### PRESET VALUES

If the preset value of 8 or 64 is chosen by the FS1 and FS0 inputs at the time of a  $\overline{RST}$  LOW-to-HIGH transition according to Table 1, the preset value is automatically loaded into the X and Y registers. No other device initialization is necessary to begin normal operation, and the IR flag is set HIGH after two LOW-to-HIGH transitions on CLKA.

### PARALLEL LOAD FROM PORT A

To program the X and Y registers from port A, the device is reset with FS0 and FS1 LOW during the LOW-to-HIGH transition of  $\overline{RST}$ . After this reset is complete, the IR flag is set HIGH after two LOW-to-HIGH transitions on CLKA. The first two writes to the FIFO do not store data in its memory but load the offset registers in the order Y, X. Each offset register of the IDT723631, IDT723641, and IDT723651 uses port-A inputs (A8-A0), (A9-A0), and (A10-A0), respectively. The highest number input is used as the most significant bit of the binary number in each case. Each register value can be programmed from 1 to 508 (IDT723631), 1 to 1020 (IDT723641), and 1 to 2044 (IDT723651). After both offset registers are programmed from port A, subsequent FIFO writes store data in the SRAM.

### SERIAL LOAD

To program the X and Y registers serially, the device is reset with FS0/SD and FS1/ $\overline{SEN}$  HIGH during the LOW-to-HIGH transition of  $\overline{RST}$ . After this reset is complete, the X and

Y register values are loaded bitwise through the FS0/SD input on each LOW-to-HIGH transition of CLKA that the FS1/ $\overline{SEN}$  input is LOW. Eighteen-, 20-, or 22-bit writes are needed to complete the programming for the IDT723631, IDT723641, or IDT723651, respectively. The first-bit write stores the most significant bit of the Y register, and the last-bit write stores the least significant bit of the X register. Each register value can be programmed from 1 to 508 (IDT723631), 1 to 1020 (IDT723641), or 1 to 2044 (IDT723651).

When the option to program the offset registers serially is chosen, the input-ready (IR) flag remains LOW until all register bits are written. The IR flag is set HIGH by the LOW-to-HIGH transition of CLKA after the last bit is loaded to allow normal FIFO operation.

### FIFO WRITE/READ OPERATION

The state of the port-A data (A0-A35) outputs is controlled by the port-A chip select ( $\overline{CSA}$ ) and the port-A write/read select ( $\overline{W/RA}$ ). The A0-A35 outputs are in the high-impedance state when either  $\overline{CSA}$  or  $\overline{W/RA}$  is HIGH. The A0-A35 outputs are active when both  $\overline{CSA}$  and  $\overline{W/RA}$  are LOW.

Data is loaded into the FIFO from the A0-A35 inputs on a LOW-to-HIGH transition of CLKA when  $\overline{CSA}$  and the port-A mailbox select (MBA) are LOW,  $\overline{W/RA}$ , the port-A enable (ENA), and the input-ready (IR) flag are HIGH (see Table 2). Writes to the FIFO are independent of any concurrent FIFO read.

The port-B control signals are identical to those of port-A with the exception that the port-B write/read select ( $\overline{W/RB}$ ) is the inverse of the port-A write/read select ( $\overline{W/RA}$ ). The state of the port-B data (B0-B35) outputs is controlled by the port-B chip select ( $\overline{CSB}$ ) and the port-B write/read select ( $\overline{W/RB}$ ). The B0-B35 outputs are in the high-impedance state when either  $\overline{CSB}$  is HIGH or  $\overline{W/RB}$  is LOW. The B0-B35 outputs are active when  $\overline{CSB}$  is LOW and  $\overline{W/RB}$  is HIGH.

Data is read from the FIFO to its output register on a LOW-to-HIGH transition of CLKB when  $\overline{CSB}$  and the port-B mailbox select (MBB) are LOW,  $\overline{W/RB}$ , the port-B enable (ENB), and the output-ready (OR) flag are HIGH (see Table 3). Reads from the FIFO are independent of any concurrent FIFO writes.

The setup- and hold-time constraints to the port clocks for the port-chip selects and write/read selects are only for enabling write and read operations and are not related to high-

FS1	FS0	$\overline{RST}$	X and Y Registers <sup>(1)</sup>
H	H	↑	Serial Load
H	L	↑	64
L	H	↑	8
L	L	↑	Parallel Load From Port A

3023 tbl 08

#### NOTE:

1. X register holds the offset for AE; Y register holds the offset for AF.

Table 1. Flag Programming

impedance control of the data outputs. If a port enable is LOW during a clock cycle, the port chip select and write/read select may change states during the setup- and hold time window of the cycle.

When the output-ready (OR) flag is LOW, the next data word is sent to the FIFO output register automatically by the CLKB LOW-to-HIGH transition that sets the output-ready flag HIGH. When OR is HIGH, an available data word is clocked to the FIFO output register only when a FIFO read is selected by the port-B chip select ( $\overline{CSB}$ ), write/read select ( $\overline{W/RB}$ ), enable (ENB), and mailbox select (MBB).

### SYNCHRONIZED FIFO FLAGS

Each IDT723631/723641/723651 FIFO flag is synchronized to its port clock through at least two flip-flop stages. This is done to improve the flags' reliability by reducing the probability of metastable events on their outputs when CLKA and CLKB operate asynchronously to one another. OR and  $\overline{AE}$  are synchronized to CLKB. IR and  $\overline{AF}$  are synchronized to CLKA. Table 4 shows the relationship of each flag to the number of words stored in memory.

### OUTPUT-READY FLAG (OR)

The output-ready flag of a FIFO is synchronized to the port clock that reads data from its array (CLKB). When the output-ready flag is HIGH, new data is present in the FIFO output

register. When the output-ready flag is LOW, the previous data word is present in the FIFO output register and attempted FIFO reads are ignored.

A FIFO read pointer is incremented each time a new word is clocked to its output register. The state machine that controls an output-ready flag monitors a write-pointer and read-pointer comparator that indicates when the FIFO SRAM status is empty, empty+1, or empty+2. From the time a word is written to a FIFO, it can be shifted to the FIFO output register in a minimum of three cycles of CLKB. Therefore, an output-ready flag is LOW if a word in memory is the next data to be sent to the FIFO output register and three CLKB cycles have not elapsed since the time the word was written. The output-ready flag of the FIFO remains LOW until the third LOW-to-HIGH transition of CLKB occurs, simultaneously forcing the output-ready flag HIGH and shifting the word to the FIFO output register.

A LOW-to-HIGH transition on CLKB begins the first synchronization cycle of a write if the clock transition occurs at time  $t_{SKEW1}$  or greater after the write. Otherwise, the subsequent CLKB cycle may be the first synchronization cycle (see Figure 6).

### INPUT READY FLAG (IR)

The input ready flag of a FIFO is synchronized to the port clock that writes data to its array (CLKA). When the input-

$\overline{CSA}$	$\overline{W/RA}$	ENA	MBA	CLKA	A0-A35 Outputs	Port Functions
H	X	X	X	X	In High-Impedance State	None
L	H	L	X	X	In High-Impedance State	None
L	H	H	L	↑	In High-Impedance State	FIFO Write
L	H	H	H	↑	In High-Impedance State	Mail1 Write
L	L	L	L	X	Active, Mail2 Register	None
L	L	H	L	↑	Active, Mail2 Register	None
L	L	L	H	X	Active, Mail2 Register	None
L	L	H	H	↑	Active, Mail2 Register	Mail2 Read (Set $\overline{MBF2}$ HIGH)

Table 2. Port-A Enable Function Table

3023 tbl 09

$\overline{CSB}$	$\overline{W/RB}$	ENB	MBB	CLKB	B0-A35 Outputs	Port Functions
H	X	X	X	X	In High-Impedance State	None
L	L	L	X	X	In High-Impedance State	None
L	L	H	L	↑	In High-Impedance State	None
L	L	H	H	↑	In High-Impedance State	Mail2 Write
L	H	L	L	X	Active, FIFO Output Register	None
L	H	H	L	↑	Active, FIFO Output Register	FIFO read
L	H	L	H	X	Active, Mail1 Register	None
L	H	H	H	↑	Active, Mail1 Register	Mail1 Read (Set $\overline{MBF1}$ HIGH)

Table 3. Port-B Enable Function Table

3023 tbl 10

ready flag is HIGH, a memory location is free in the SRAM to write new data. No memory locations are free when the input-ready flag is LOW and attempted writes to the FIFO are ignored.

Each time a word is written to a FIFO, its write pointer is incremented. The state machine that controls an input-ready flag monitors a write-pointer and read pointer comparator that indicates when the FIFO SRAM status is full, full-1, or full-2. From the time a word is read from a FIFO, its previous memory location is ready to be written in a minimum of three cycles of CLKA. Therefore, an input-ready flag is LOW if less than two cycles of CLKA have elapsed since the next memory write location has been read. The second LOW-to-HIGH transition on CLKA after the read sets the input-ready flag HIGH, and data can be written in the following cycle.

A LOW-to-HIGH transition on CLKA begins the first synchronization cycle of a read if the clock transition occurs at time  $t_{SKEW1}$  or greater after the read. Otherwise, the subsequent CLKA cycle may be the first synchronization cycle (see Figure 7).

#### ALMOST-EMPTY FLAG ( $\overline{AE}$ )

The almost-empty flag of a FIFO is synchronized to the port clock that reads data from its array (CLKB). The state machine that controls an almost-empty flag monitors a write-pointer and read-pointer comparator that indicates when the FIFO SRAM status is almost empty, almost empty+1, or almost empty+2. The almost-empty state is defined by the contents of register X. This register is loaded with a preset value during a FIFO reset, programmed from port A, or programmed serially (see almost-empty flag and almost-full flag offset programming above). The almost-empty flag is LOW when the FIFO contains X or less words and is HIGH when the FIFO contains (X+1) or more words. A data word present in the FIFO output register has been read from memory.

Two LOW-to-HIGH transitions of CLKB are required after a FIFO write for the almost-empty flag to reflect the new level of fill; therefore, the almost-empty flag of a FIFO containing (X+1) or more words remains LOW if two cycles of CLKB have not elapsed since the write that filled the memory to the (X+1)

level. An almost-empty flag is set HIGH by the second LOW-to-HIGH transition of CLKB after the FIFO write that fills memory to the (X+1) level. A LOW-to-HIGH transition of CLKB begins the first synchronization cycle if it occurs at time  $t_{SKEW2}$  or greater after the write that fills the FIFO to (X+1) words. Otherwise, the subsequent CLKB cycle may be the first synchronization cycle (see Figure 8).

#### ALMOST-FULL FLAG ( $\overline{AF}$ )

The almost-full flag of a FIFO is synchronized to the port clock that writes data to its array (CLKA). The state machine that controls an almost-full flag monitors a write-pointer and read-pointer comparator that indicates when the FIFO SRAM status is almost full, almost full-1, or almost full-2. The almost-full state is defined by the contents of register Y. This register is loaded with a preset value during a FIFO reset, programmed from port A, or programmed serially (see almost-empty flag and almost-full flag offset programming). The almost-full flag is LOW when the number of words in the FIFO is greater than or equal to (512-Y), (1024-Y), OR (2048-Y) for the IDT723631, IDT723641, or IDT723651, respectively. The almost-full flag is HIGH when the number of words in the FIFO is less than or equal to [512-(Y+1)], [1024-(Y+1)], or [2048-(Y+1)] for the IDT723631, IDT723641, or IDT723651, respectively. A data word present in the FIFO output register has been read from memory.

Two LOW-to-HIGH transitions of CLKA are required after a FIFO read for its almost-full flag to reflect the new level of fill. Therefore, the almost-full flag of a FIFO containing [512/1024/2048-(Y+1)] or less words remains LOW if two cycles of CLKA have not elapsed since the read that reduced the number of words in memory to [512/1024/2048-(Y+1)]. An almost-full flag is set HIGH by the second LOW-to-HIGH transition of CLKA after the FIFO read that reduces the number of words in memory to [512/1024/2048-(Y+1)]. A LOW-to-HIGH transition of CLKA begins the first synchronization cycle if it occurs at time  $t_{SKEW2}$  or greater after the read that reduces the number of words in memory to [512/1024/2048-(Y+1)]. Otherwise, the subsequent CLKA cycle may be the first synchronization cycle (see Figure 9).

Number of Words in the FIFO <sup>(1,2)</sup>			Synchronized to CLKB		Synchronized to CLKA	
IDT723631	IDT723641	IDT723651	OR	$\overline{AE}$	$\overline{AF}$	IR
0	0	0	L	L	H	H
1 to X	1 to X	1 to X	H	L	H	H
(X+1) to [512-(Y+1)]	(X+1) to [1024-(Y+1)]	(X+1) to [2048-(Y+1)]	H	H	H	H
(512-Y) to 511	(1024-Y) to 1023	(2048-Y) to 2047	H	H	L	H
512	1024	2048	H	H	L	L

3023 tbl 11

#### NOTES:

1. X is the almost-empty offset for  $\overline{AE}$ . Y is the almost-full offset for  $\overline{AF}$ .
2. When a word is present in the FIFO output register, its previous memory location is free.

Table 4. FIFO Flag Operation

## SYNCHRONOUS RETRANSMIT

The synchronous retransmit feature of the IDT723631/723641/723651 allows FIFO data to be read repeatedly starting at a user-selected position. The FIFO is first put into retransmit mode to select a beginning word and prevent on-going FIFO write operations from destroying retransmit data. Data vectors with a minimum length of three words can retransmit repeatedly starting at the selected word. The FIFO can be taken out of retransmit mode at any time and allow normal device operation.

The FIFO is put in retransmit mode by a LOW-to-HIGH transition on CLKB when the retransmit mode (RTM) input is HIGH and OR is HIGH. The rising CLKB edge marks the data present in the FIFO output register as the first retransmit data. The FIFO remains in retransmit mode until a LOW-to-HIGH transition occurs while RTM is LOW.

When two or more reads have been done past the initial retransmit word, a retransmit is initiated by a LOW-to-HIGH transition on CLKB when the read-from-mark (RFM) input is HIGH. This rising CLKB edge shifts the first retransmit word to the FIFO output register and subsequent reads can begin immediately. Retransmit loops can be done endlessly while the FIFO is in retransmit mode. RFM must be LOW during the CLKB rising edge that takes the FIFO out of retransmit mode.

When the FIFO is put into retransmit mode, it operates with two read pointers. The current read pointer operates normally, incrementing each time a new word is shifted to the FIFO output register and used by the OR and  $\overline{AE}$  flags. The shadow read pointer stores the SRAM location at the time the device is put into retransmit mode and does not change until the device is taken out of retransmit mode. The shadow read pointer is used by the IR and  $\overline{AF}$  flags. Data writes can proceed while the FIFO is in retransmit mode, but  $\overline{AF}$  is set LOW by the write that stores (512 - Y), (1024 - Y), or (2048 - Y) words after the first retransmit word for the IDT723631, IDT723641, or IDT723651, respectively. The IR flag is set LOW by the 512th, 1024th, or 2048th write after the first retransmit word for the IDT723631, IDT723641, or IDT723651, respectively.

When the FIFO is in retransmit mode and RFM is HIGH, a rising CLKB edge loads the current read pointer with the shadow read-pointer value and the OR flag reflects the new

level of fill immediately. If the retransmit changes the FIFO status out of the almost-empty range, up to two CLKB rising edges after the retransmit cycle are needed to switch  $\overline{AE}$  high (see Figure 11). The rising CLKB edge that takes the FIFO out of retransmit mode shifts the read pointer used by the IR and  $\overline{AF}$  flags from the shadow to the current read pointer. If the change of read pointer used by IR and  $\overline{AF}$  should cause one or both flags to transmit HIGH, at least two CLKA synchronizing cycles are needed before the flags reflect the change. A rising CLKA edge after the FIFO is taken out of retransmit mode is the first synchronizing cycle of IR if it occurs at time  $t_{SKEW1}$  or greater after the rising CLKB edge (see Figure 12). A rising CLKA edge after the FIFO is taken out of retransmit mode is the first synchronizing cycle of  $\overline{AF}$  if it occurs at time  $t_{SKEW2}$  or greater after the rising CLKB edge (see Figure 14).

## MAILBOX REGISTERS

Two 36-bit bypass registers are on the IDT723631/723641/723651 to pass command and control information between port A and port B. The mailbox-select (MBA, MBB) inputs choose between a mail register and a FIFO for a port data transfer operation. A LOW-to-HIGH transition on CLKA writes A0-A35 data to the mail1 register when a port-A write is selected by  $\overline{CSA}$ ,  $\overline{W/RA}$ , and ENA with MBA HIGH. A LOW-to-HIGH transition on CLKB writes B0-B35 data to the mail2 register when a port-B write is selected by  $\overline{CSB}$ ,  $\overline{W/RB}$ , and ENB with MBB HIGH. Writing data to a mail register sets its corresponding flag ( $\overline{MBF1}$  or  $\overline{MBF2}$ ) LOW. Attempted writes to a mail register are ignored while its mail flag is LOW.

When the port-B data (B0-B35) outputs are active, the data on the bus comes from the FIFO output register when the port-B mailbox select (MBB) input is LOW and from the mail1 register when MBB is HIGH. Mail2 data is always present on the port-A data (A0-A35) outputs when they are active. The mail1 register flag ( $\overline{MBF1}$ ) is set HIGH by a LOW-to-HIGH transition on CLKB when a port-B read is selected by  $\overline{CSB}$ ,  $\overline{W/RB}$ , and ENB with MBB HIGH. The mail2 register flag ( $\overline{MBF2}$ ) is set HIGH by a LOW-to-HIGH transition on CLKA when a port-A read is selected by  $\overline{CSA}$ ,  $\overline{W/RA}$ , and ENA with MBA HIGH. The data in a mail register remains intact after it is read and changes only when new data is written to the register.

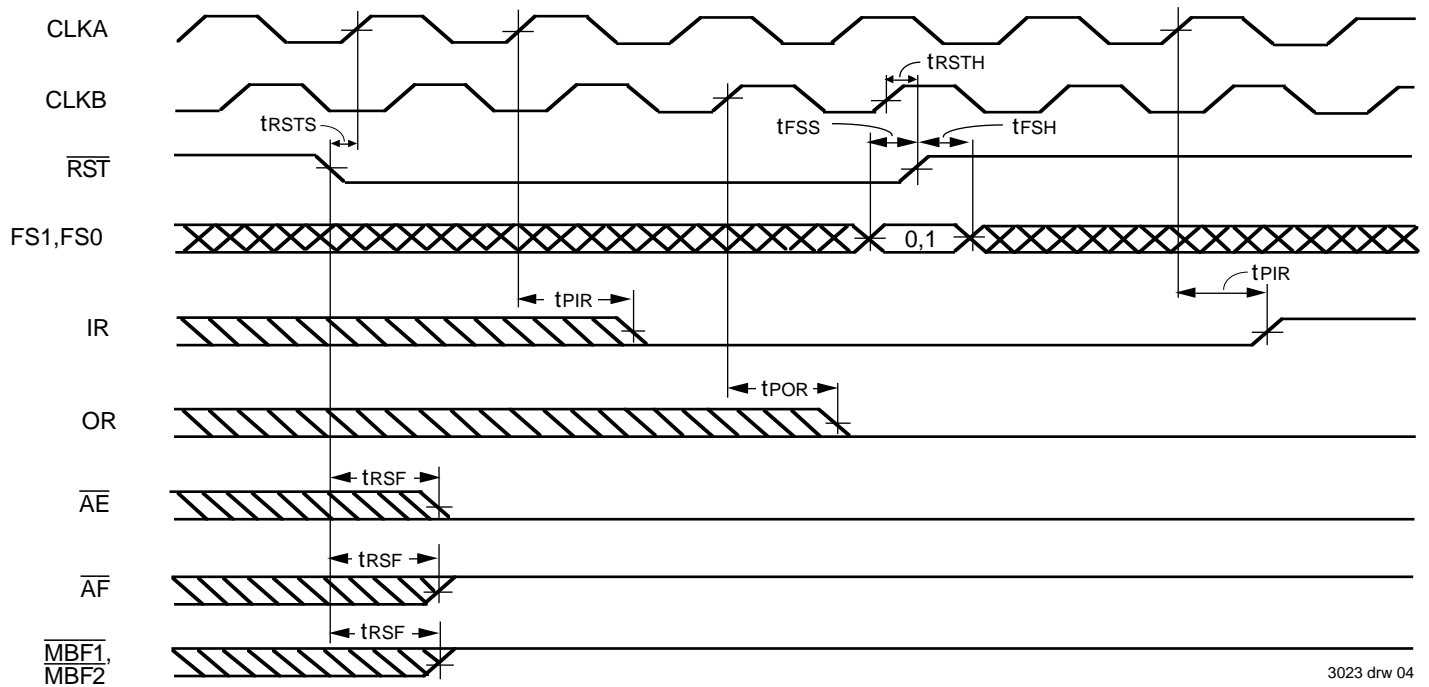

3023 drw 04

Figure 1. FIFO Reset Loading X and Y with a Preset Value of Eight

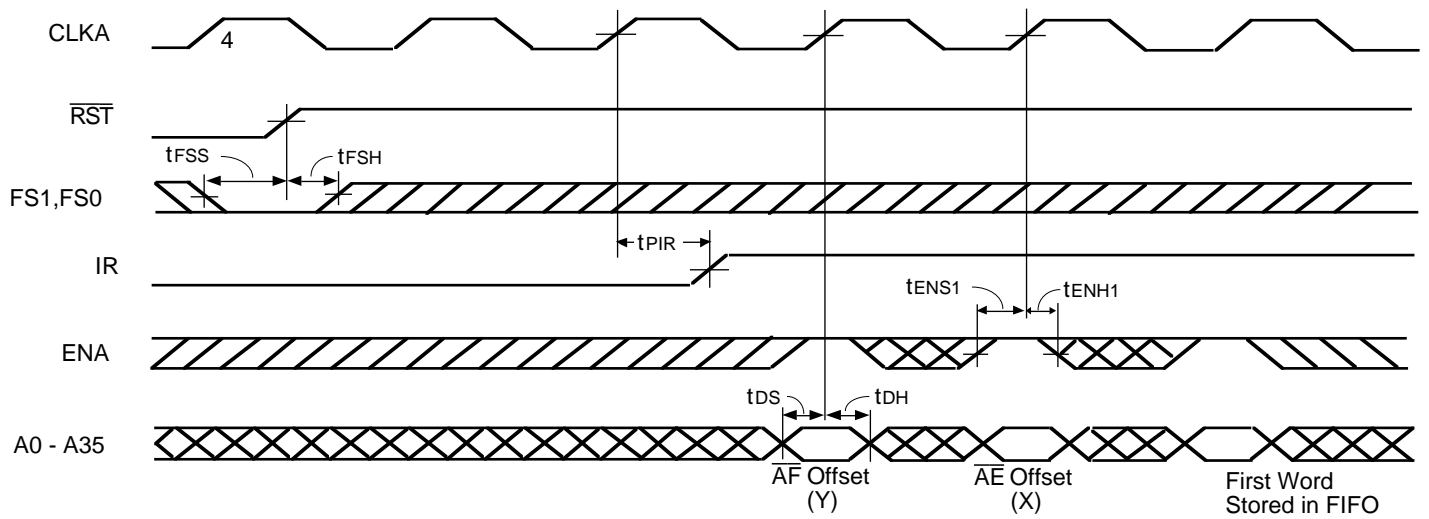

3023 drw 05

NOTE:

1.  $\overline{CSA}$  = LOW,  $\overline{W/RA}$  = HIGH,  $\overline{MBA}$  = LOW. It is not necessary to program offset register on consecutive clock cycles.

Figure 2. Programming the Almost-Full Flag and Almost-Empty Flag Offset Values from Port A

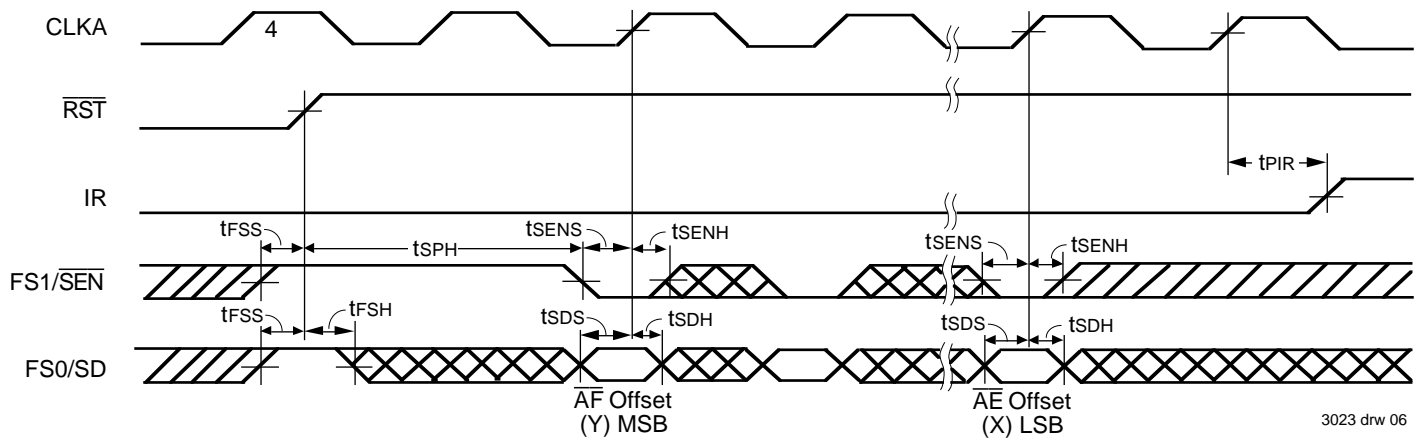

3023 drw 06

NOTE:

1. It is not necessary to program offset register bits on consecutive clock cycles. FIFO write attempts are ignored until IR is set HIGH.

Figure 3. Programming the Almost-Full Flag and Almost-Empty Flag Offset Values Serially

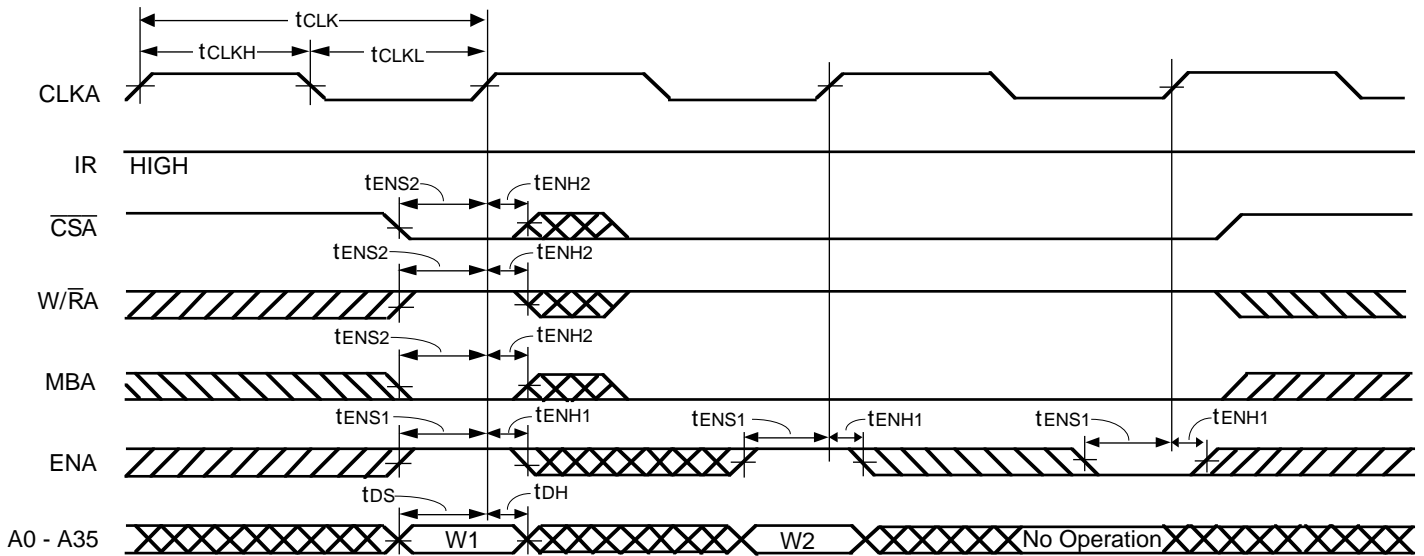

3023 drw 07

Figure 4. FIFO Write-Cycle Timing

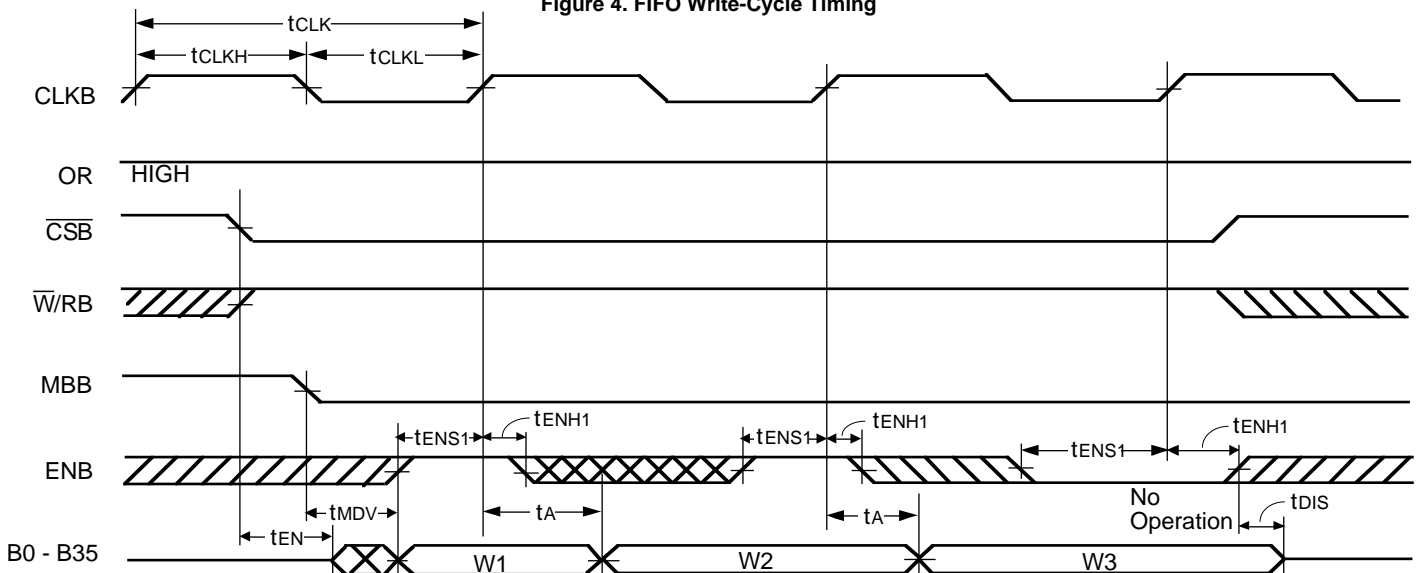

3023 drw 08

Figure 5. FIFO Read-Cycle Timing

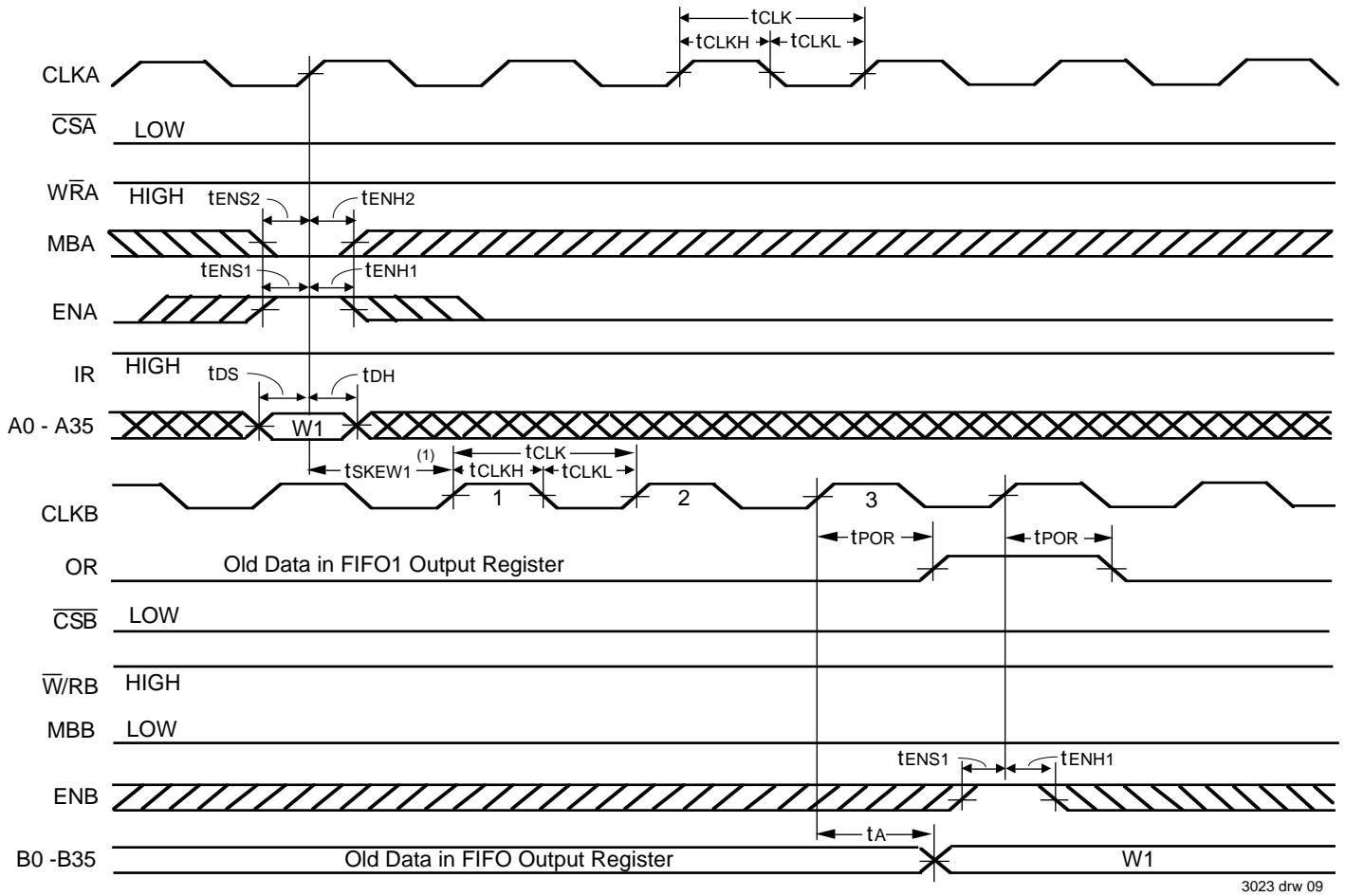

3023 drw 09

NOTE:

1. tSKEW1 is the minimum time between a rising CLKA edge and a rising CLKB edge for OR to transition HIGH and to clock the next word to the FIFO output register in three CLKB cycles. If the time between the rising CLKA edge and rising CLKB edge is less than tSKEW1, then the transition of OR HIGH and the first word load to the output register may occur one CLKB cycle later than shown.

Figure 6. OR Flag Timing and First Data Word Fallthrough when the FIFO is Empty

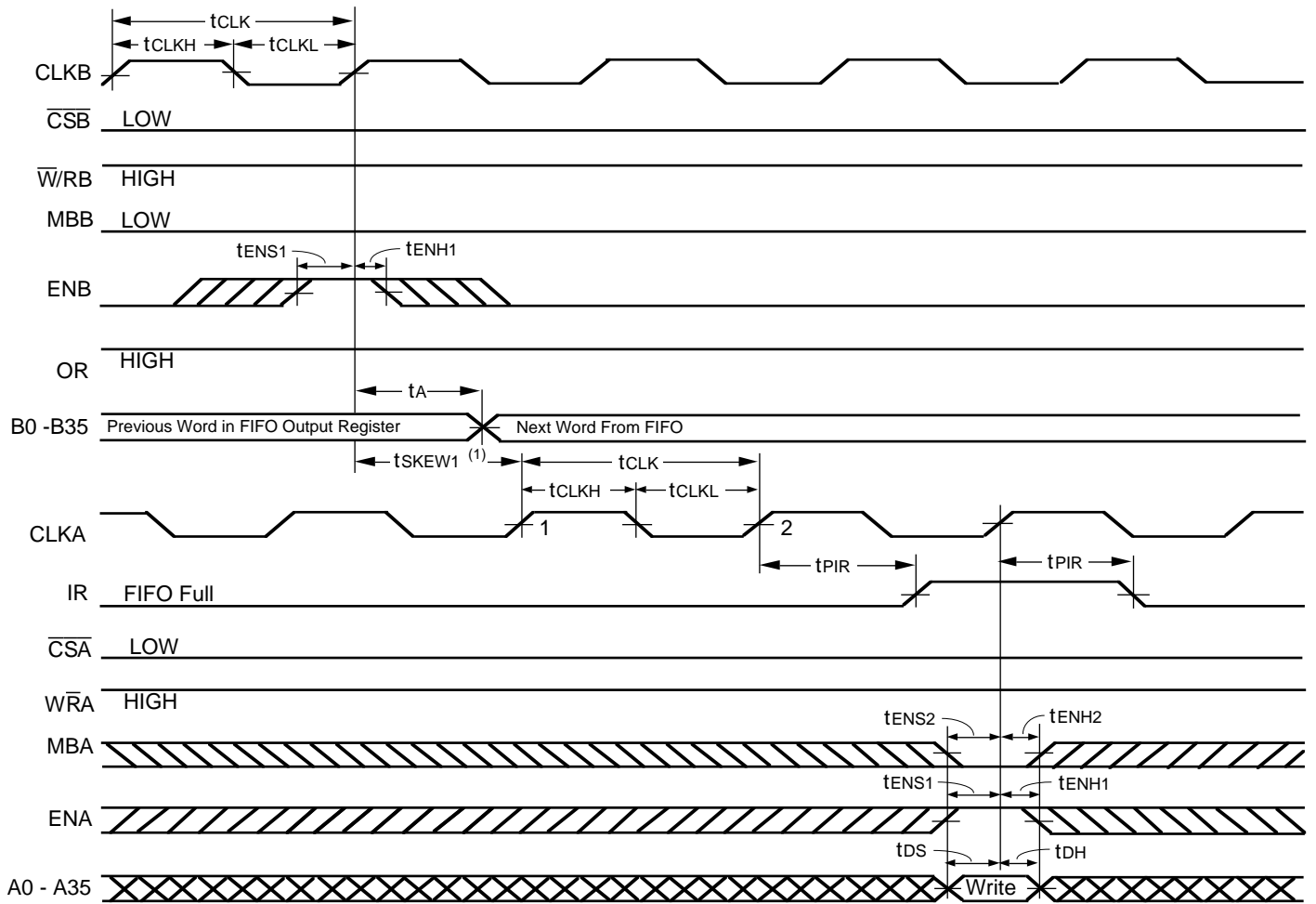

3023 drw 10

NOTE:

1.  $t_{SKEW1}$  is the minimum time between a rising  $CLKB$  edge and a rising  $CLKA$  edge for  $IR$  to transition HIGH in the next  $CLKA$  cycle. If the time between the rising  $CLKB$  edge and rising  $CLKA$  edge is less than  $t_{SKEW1}$ , then  $IR$  may transition HIGH one  $CLKA$  cycle later than shown.

Figure 7. IR Flag Timing and First Available Write when the FIFO is Full

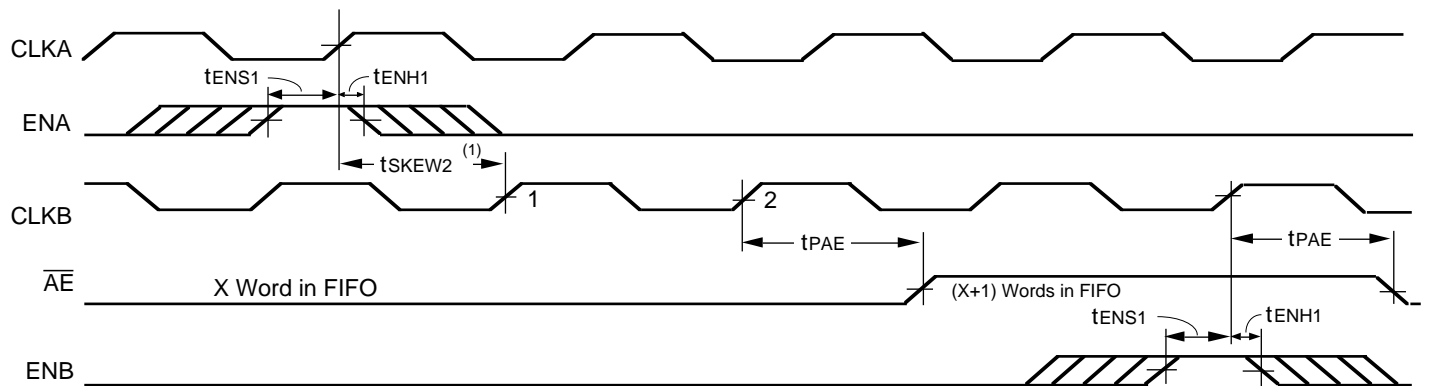

3023 drw 11

NOTES:

1.  $t_{SKEW2}$  is the minimum time between a rising  $CLKA$  edge and a rising  $CLKB$  edge for  $\overline{AE}$  to transition HIGH in the next  $CLKB$  cycle. If the time between the rising  $CLKA$  edge and rising  $CLKB$  edge is less than  $t_{SKEW2}$ , then  $\overline{AE}$  may transition HIGH one  $CLKB$  cycle later than shown.
2. FIFO write ( $\overline{CSA} = LOW$ ,  $W/\overline{RA} = HIGH$ ,  $MBA = LOW$ ), FIFO read ( $\overline{CSB} = LOW$ ,  $\overline{W}/RB = HIGH$ ,  $MBB = LOW$ ).

Figure 8. Timing for  $\overline{AE}$  when FIFO is Almost Empty





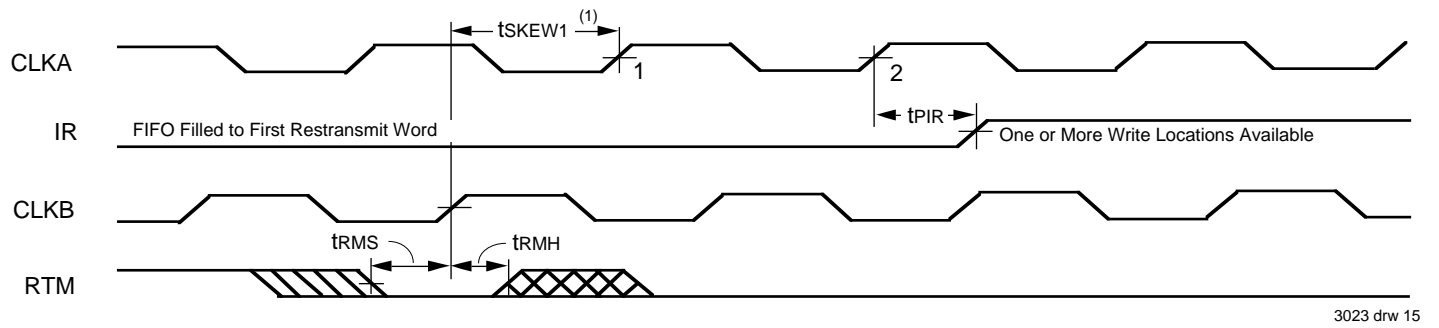

3023 drw 15

NOTE:

1.  $t_{SKEW1}$  is the minimum time between a rising CLK B edge and a rising CLK A edge for IR to transition HIGH in the next CLK A cycle. If the time between the rising CLK B edge and rising CLK A edge is less than  $t_{SKEW1}$ , then IR may transition HIGH one CLK A cycle later than shown.

Figure 12. IR Timing from the End of Retransmit Mode when One or More Write Locations are Available

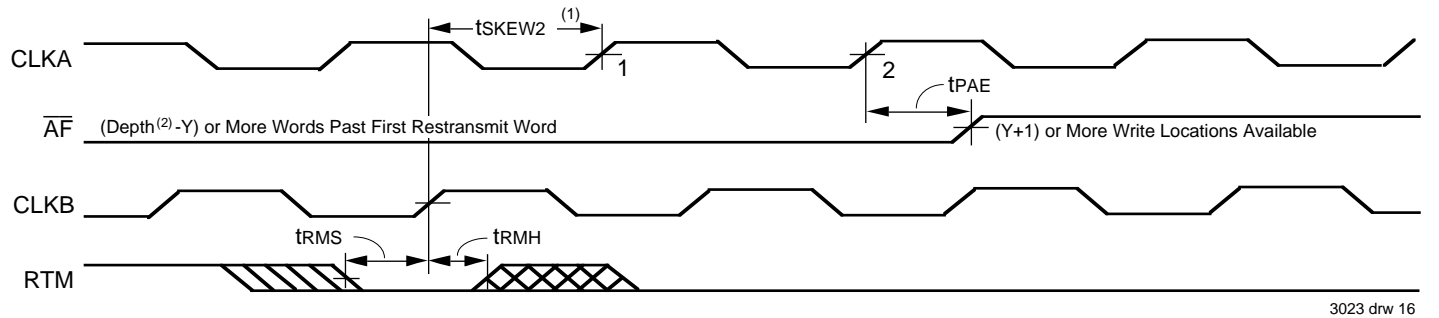

3023 drw 16

NOTES:

1.  $t_{SKEW2}$  is the minimum time between a rising CLK B edge and a rising CLK A edge for AF to transition HIGH in the next CLK A cycle. If the time between the rising CLK B edge and rising CLK A edge is less than  $t_{SKEW2}$ , then AF may transition HIGH one CLK A cycle later than shown.
2. Depth is 512 for the IDT723631, 1024 for the IDT723641, and 2048 for the IDT723651.
3. Y is the value loaded in the almost-full flag offset register.

Figure 13.  $\overline{AF}$  Timing from the End of Retransmit Mode when (Y+1) or More Write Locations are Available

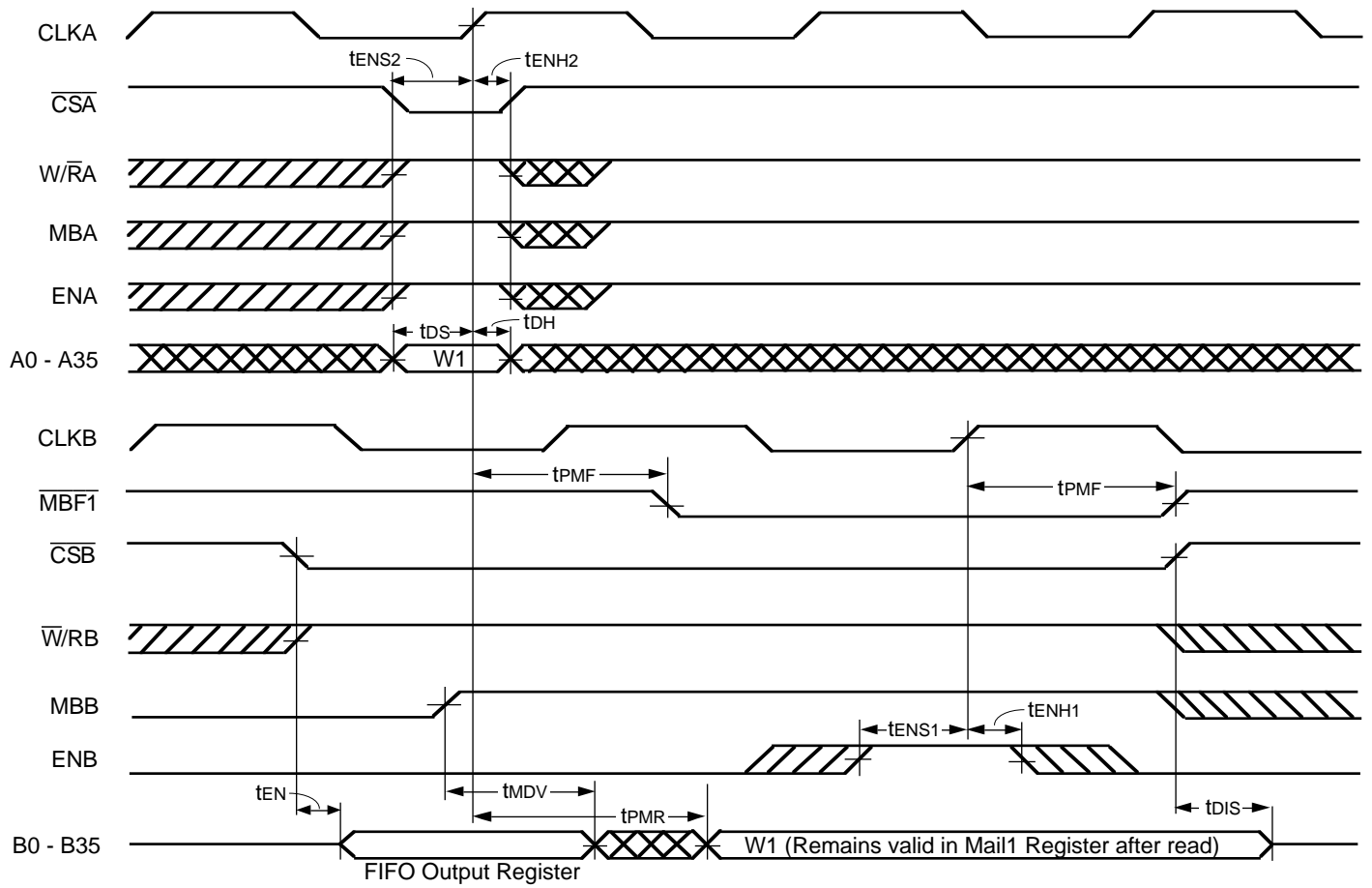

3023 drw 17

Figure 14. Timing for Mail1 Register and  $\overline{MBF1}$  Flag

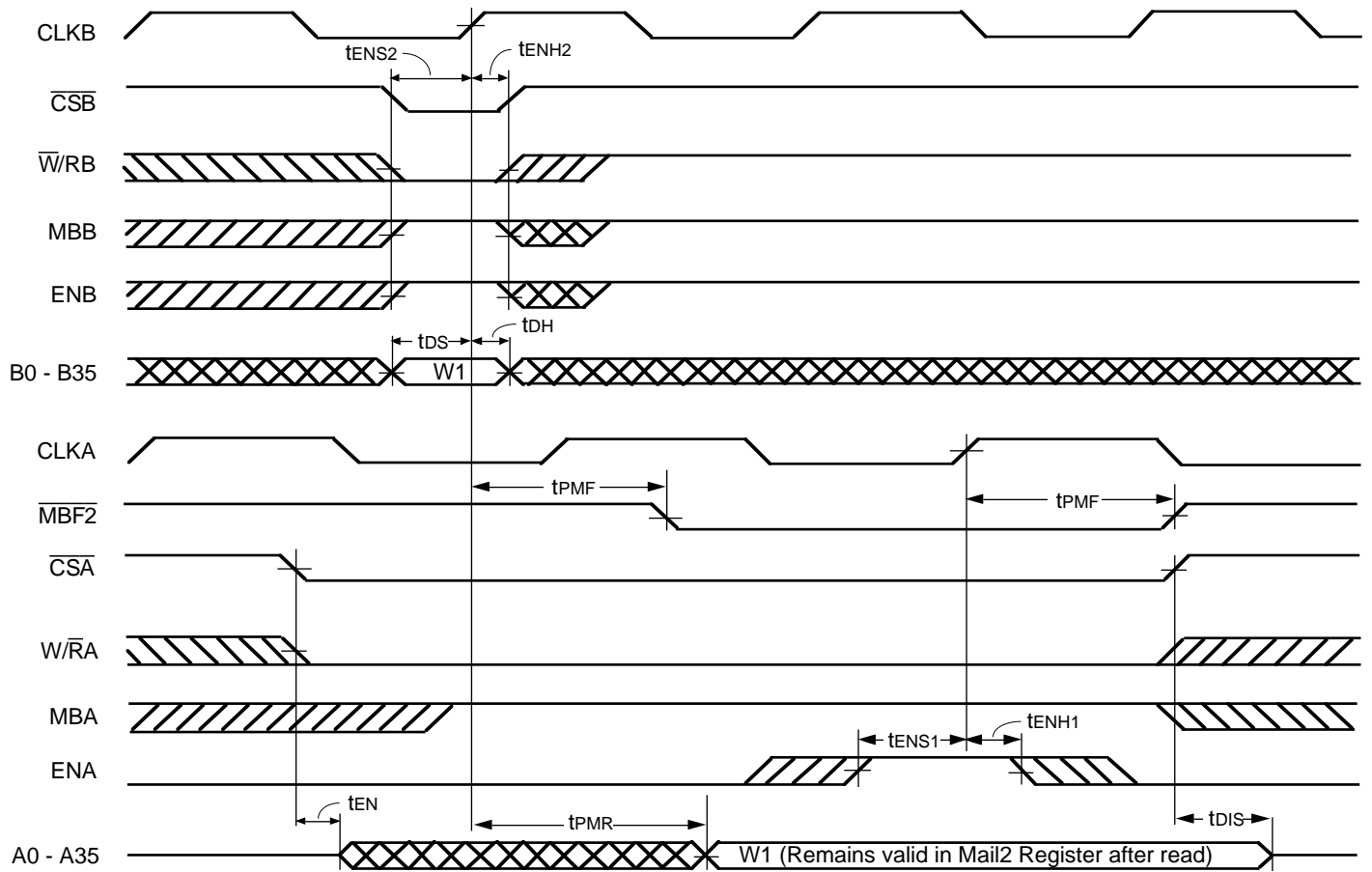

3023 drw 18

Figure 15. Timing for Mail2 Register and MBF2 Flag

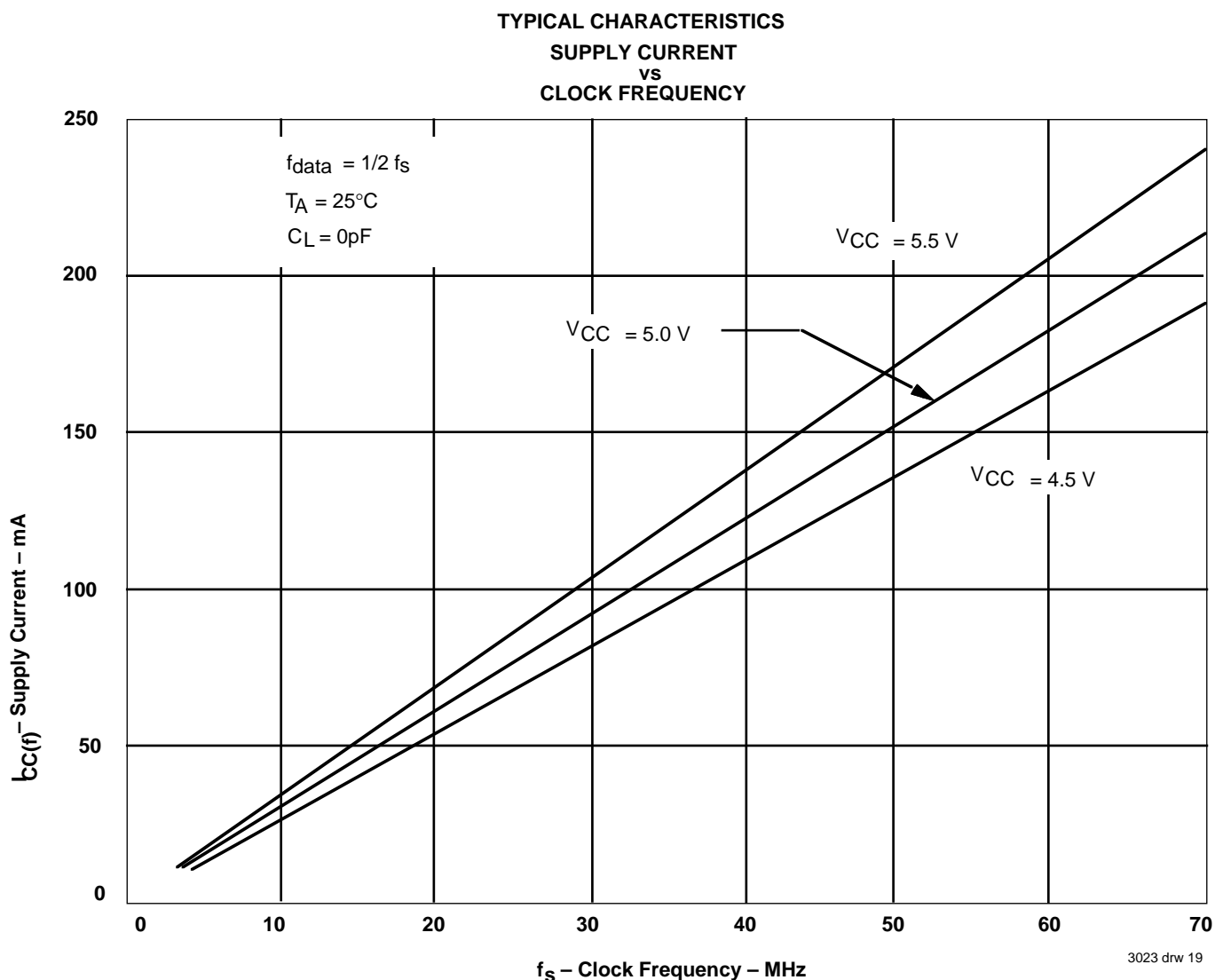

Figure 16

### CALCULATING POWER DISSIPATION

The I<sub>CC</sub>(f) current for the graph in Figure 16 was taken while simultaneously reading and writing the FIFO on the IDT723641 with CLKA and CLKB set to f<sub>S</sub>. All data inputs and data outputs change state during each clock cycle to consume the highest supply current. Data outputs were disconnected to normalize the graph to a zero-capacitance load. Once the capacitance load per data-output channel and the number of IDT723631/723641/723651 inputs driven by TTL HIGH levels are known, the power dissipation can be calculated with the equation below.

With I<sub>CC</sub>(f) taken from Figure 16, the maximum power dissipation (PT) of the IDT723631/723641/723651 may be calculated by:

$$PT = V_{CC} \times [I_{CC}(f) + (N \times \Delta I_{CC} \times dc)] + \sum (C_L \times V_{CC}^2 \times f_o)$$

where:

- N = number of inputs driven by TTL levels
- ΔI<sub>CC</sub> = increase in power supply current for each input at a TTL HIGH level
- dc = duty cycle of inputs at a TTL HIGH level of 3.4
- C<sub>L</sub> = output capacitance load
- f<sub>o</sub> = switching frequency of an output

When no reads or writes are occurring on the IDT723631/723641/723651, the power dissipated by a single clock (CLKA or CLKB) input running at frequency f<sub>S</sub> is calculated by:

$$PT = V_{CC} \times f_S \times 0.209 \text{ mA/MHz}$$

## PARAMETER MEASUREMENT INFORMATION

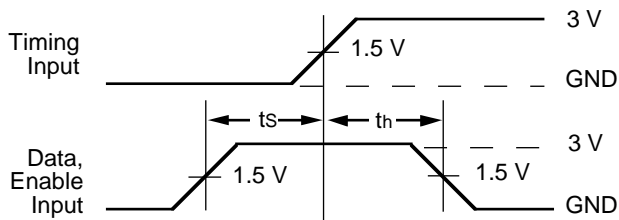
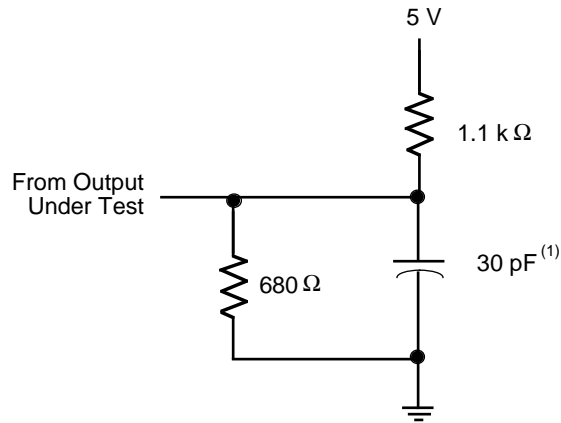

**VOLTAGE WAVEFORMS  
 SETUP AND HOLD TIMES**

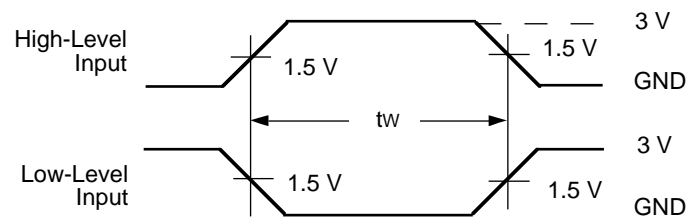

**VOLTAGE WAVEFORMS  
 PULSE DURATIONS**

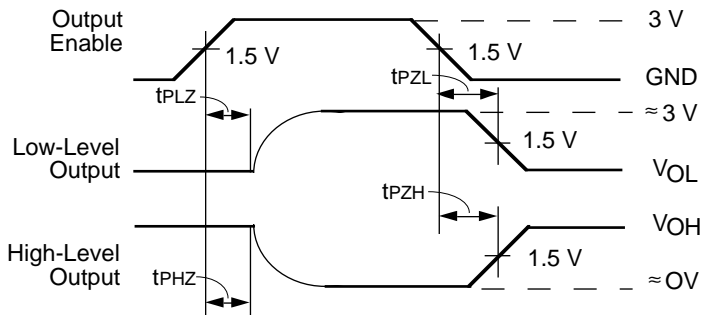

**VOLTAGE WAVEFORMS  
 ENABLE AND DISABLE TIMES**

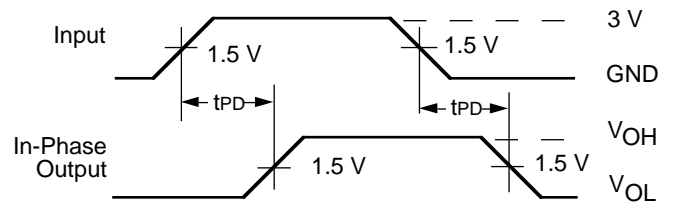

**VOLTAGE WAVEFORMS  
 PROPAGATION DELAY TIMES**

3023 drw 20

**NOTE:**

1. Includes probe and jig capacitance

**Figure 17. Load Circuit and Voltage Waveforms**

## ORDERING INFORMATION

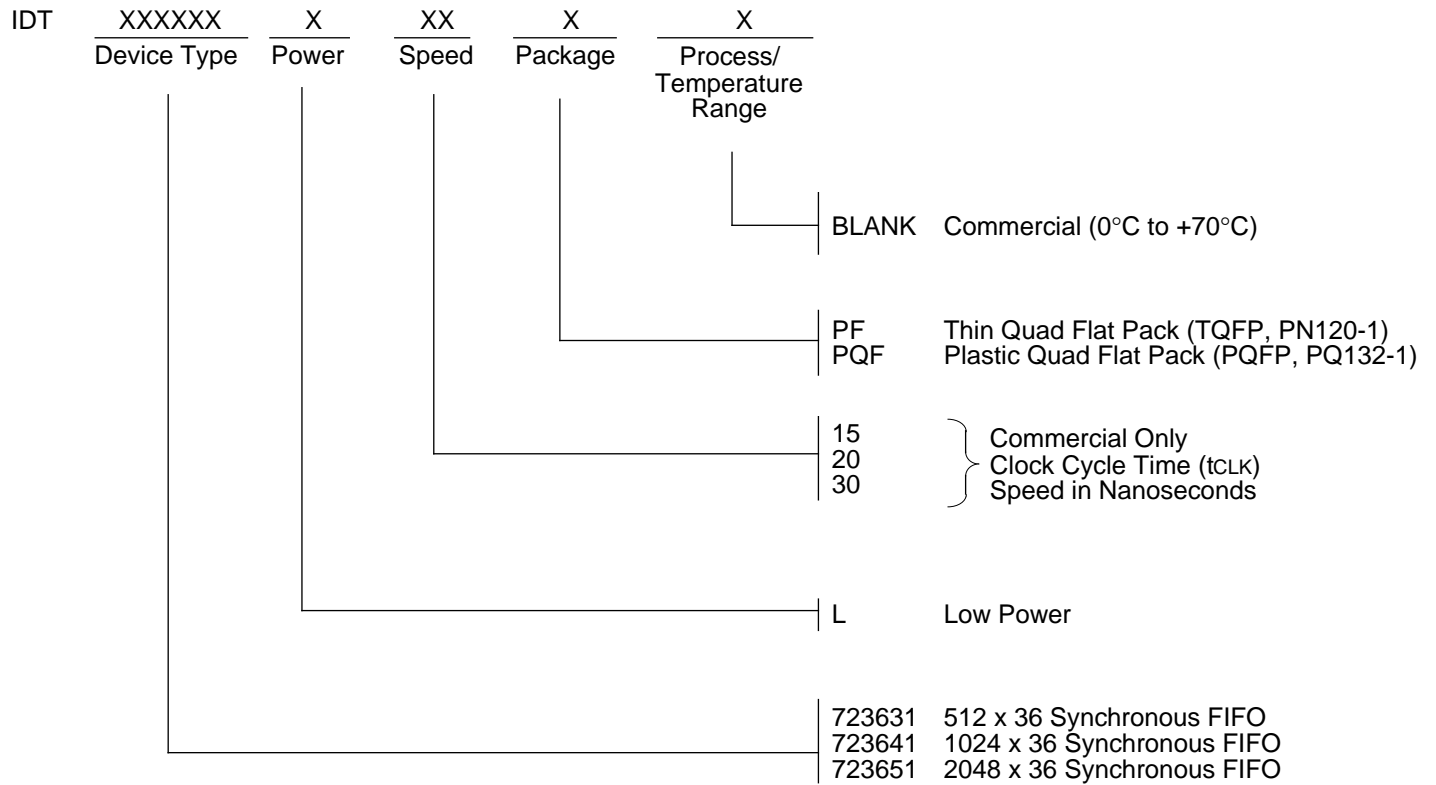

3023 drw 21

This datasheet has been downloaded from:

[www.DatasheetCatalog.com](http://www.DatasheetCatalog.com)

Datasheets for electronic components.