

Features

- Generation 4 IGBT technology
- UltraFast: Optimized for high operating frequencies 8-40 kHz in hard switching, >200 kHz in resonant mode
- Very low conduction and switching losses
- HEXFRED™ antiparallel diodes with ultra- soft recovery
- Industry standard package
- UL approved

Benefits

- Increased operating efficiency
- Direct mounting to heatsink
- Performance optimized for power conversion: UPS, SMPS, Welding
- Lower EMI, requires less snubbing

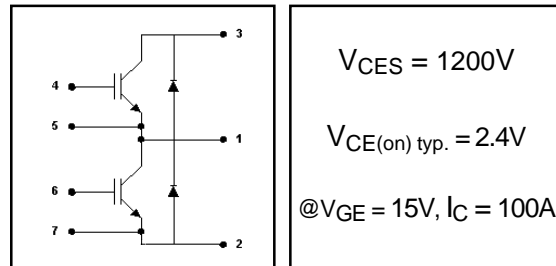

$V_{CES} = 1200V$
 $V_{CE(on) typ.} = 2.4V$
 @ $V_{GE} = 15V, I_C = 100A$

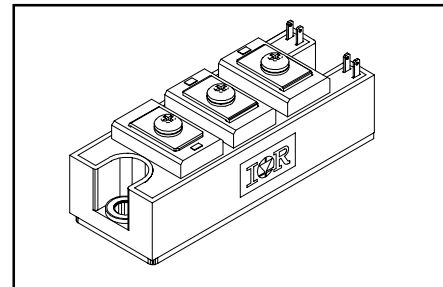

Absolute Maximum Ratings

	Parameter	Max.	Units
V_{CES}	Collector-to-Emitter Voltage	1200	V
$I_C @ T_C = 25^\circ C$	Continuous Collector Current	100	A
I_{CM}	Pulsed Collector Current ①	200	
I_{LM}	Peak Switching Current ②	200	
I_{FM}	Peak Diode Forward Current	200	
V_{GE}	Gate-to-Emitter Voltage	± 20	V
V_{ISOL}	RMS Isolation Voltage, Any Terminal To Case, t = 1 min	2500	
$P_D @ T_C = 25^\circ C$	Maximum Power Dissipation	520	W
$P_D @ T_C = 85^\circ C$	Maximum Power Dissipation	270	
T_J	Operating Junction Temperature Range	-40 to +150	$^\circ C$
T_{STG}	Storage Temperature Range	-40 to +125	

Thermal / Mechanical Characteristics

	Parameter	Typ.	Max.	Units
$R_{\theta JC}$	Thermal Resistance, Junction-to-Case - IGBT	—	0.24	$^\circ C/W$
$R_{\theta JC}$	Thermal Resistance, Junction-to-Case - Diode	—	0.35	
$R_{\theta CS}$	Thermal Resistance, Case-to-Sink - Module	0.1	—	
	Mounting Torque, Case-to-Heatsink	—	4.0	N·m
	Mounting Torque, Case-to-Terminal 1, 2 & 3 ③	—	3.0	
	Weight of Module	200	—	g

Electrical Characteristics @ T_J = 25°C (unless otherwise specified)

	Parameter	Min.	Typ.	Max.	Units	Conditions
V _{(BR)CES}	Collector-to-Emitter Breakdown Voltage	1200	—	—	V	V _{GE} = 0V, I _C = 1mA
V _{CE(on)}	Collector-to-Emitter Voltage	—	2.4	2.9		V _{GE} = 15V, I _C = 100A
		—	2.2	—		V _{GE} = 15V, I _C = 100A, T _J = 125°C
V _{GE(th)}	Gate Threshold Voltage	3.0	—	6.0		I _C = 1.25mA
ΔV _{GE(th)/ΔT_J}	Temperature Coeff. of Threshold Voltage	—	-11	—	mV/°C	V _{CE} = V _{GE} , I _C = 1.25mA
g _{fe}	Forward Transconductance ④	—	136	—	S	V _{CE} = 25V, I _C = 100A
I _{CES}	Collector-to-Emitter Leaking Current	—	—	1.0	mA	V _{GE} = 0V, V _{CE} = 1200V
		—	—	10		V _{GE} = 0V, V _{CE} = 1200V, T _J = 125°C
V _{FM}	Diode Forward Voltage - Maximum	—	3.3	4.0	V	I _F = 100A, V _{GE} = 0V
		—	3.2	—		I _F = 100A, V _{GE} = 0V, T _J = 125°C
I _{GES}	Gate-to-Emitter Leakage Current	—	—	250	nA	V _{GE} = ±20V

Dynamic Characteristics - T_J = 125°C (unless otherwise specified)

	Parameter	Min.	Typ.	Max.	Units	Conditions
Q _g	Total Gate Charge (turn-on)	—	830	1245	nC	V _{CC} = 400V
Q _{ge}	Gate - Emitter Charge (turn-on)	—	140	210		I _C = 124A
Q _{gc}	Gate - Collector Charge (turn-on)	—	275	412		T _J = 25°C
t _{d(on)}	Turn-On Delay Time	—	172	—	ns	R _{G1} = 15Ω, R _{G2} = 0Ω,
t _r	Rise Time	—	141	—		I _C = 100A
t _{d(off)}	Turn-Off Delay Time	—	435	—		V _{CC} = 720V
t _f	Fall Time	—	343	—		V _{GE} = ±15V
E _{on}	Turn-On Switching Energy	—	14	—	mJ	
E _{off (1)}	Turn-Off Switching Energy	—	21	—		
E _{ts (1)}	Total Switching Energy	—	35	52		
C _{ies}	Input Capacitance	—	18672	—	pF	V _{GE} = 0V
C _{oes}	Output Capacitance	—	830	—		V _{CC} = 30V
C _{res}	Reverse Transfer Capacitance	—	161	—		f = 1 MHz
t _{rr}	Diode Reverse Recovery Time	—	149	—	ns	I _C = 100A
I _{rr}	Diode Peak Reverse Current	—	104	—		A
Q _{rr}	Diode Recovery Charge	—	7664	—	μC	R _{G2} = 0Ω
di _(rec) M _{/dt}	Diode Peak Rate of Fall of Recovery During t _b	—	1916	—	A/μs	V _{CC} = 720V di/dt » 1300A/μs

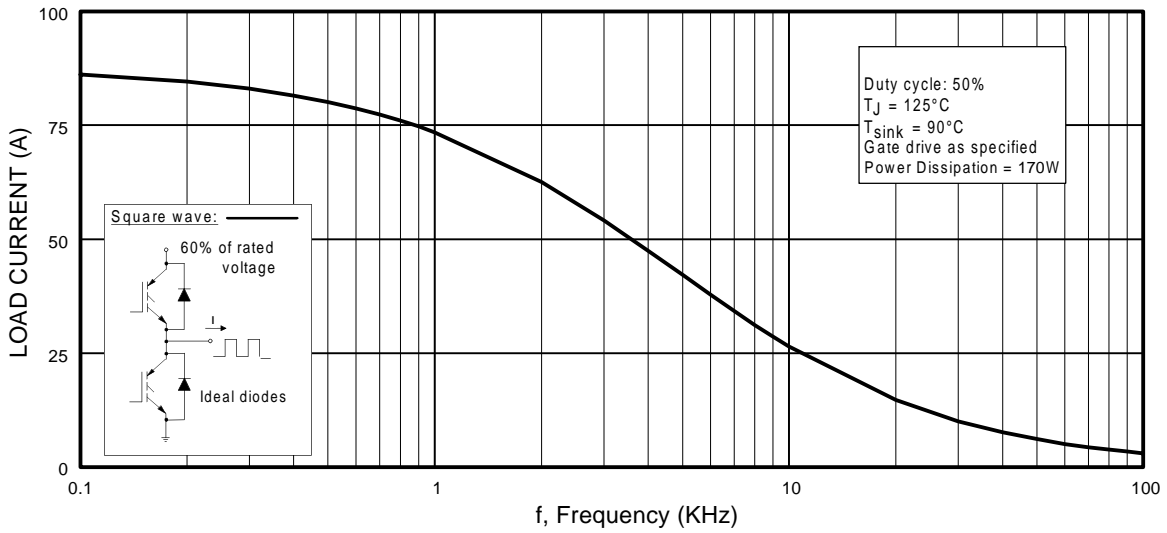

Fig. 1 - Typical Load Current vs. Frequency
 (Load Current = I_{RMS} of fundamental)

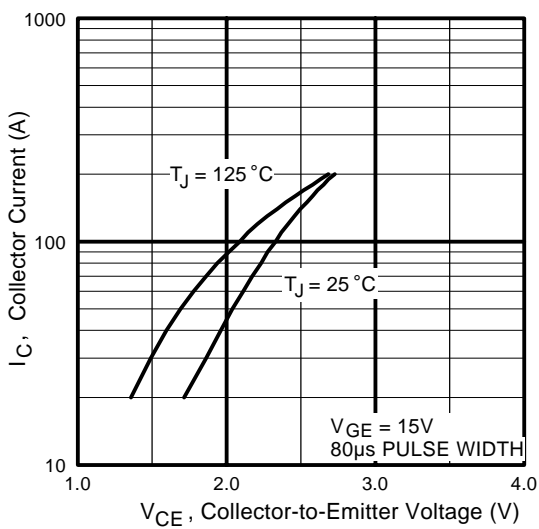

Fig. 2 - Typical Output Characteristics

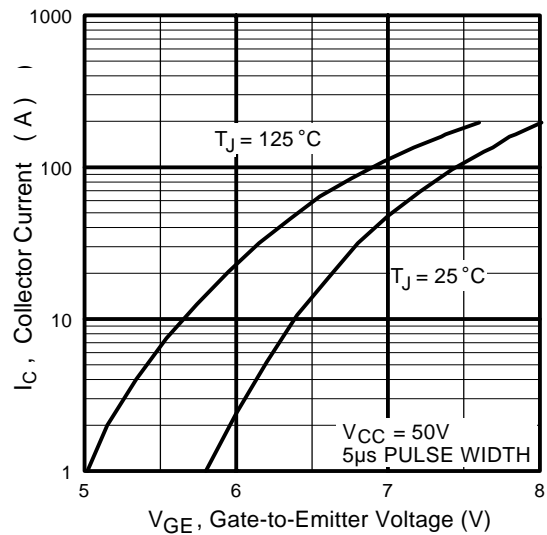

Fig. 3 - Typical Transfer Characteristics

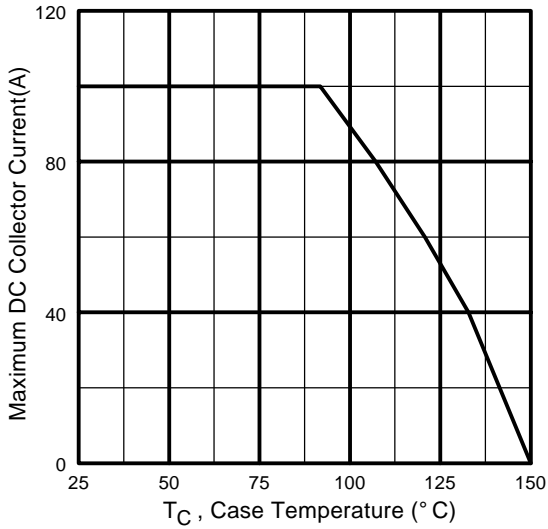

Fig. 4 - Maximum Collector Current vs. Case Temperature

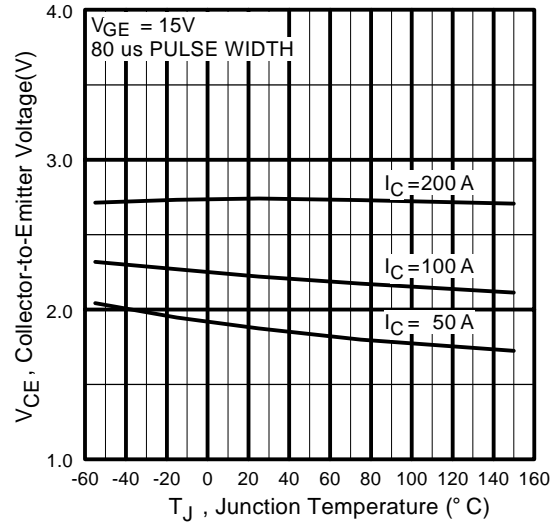

Fig. 5 - Typical Collector-to-Emitter Voltage vs. Junction Temperature

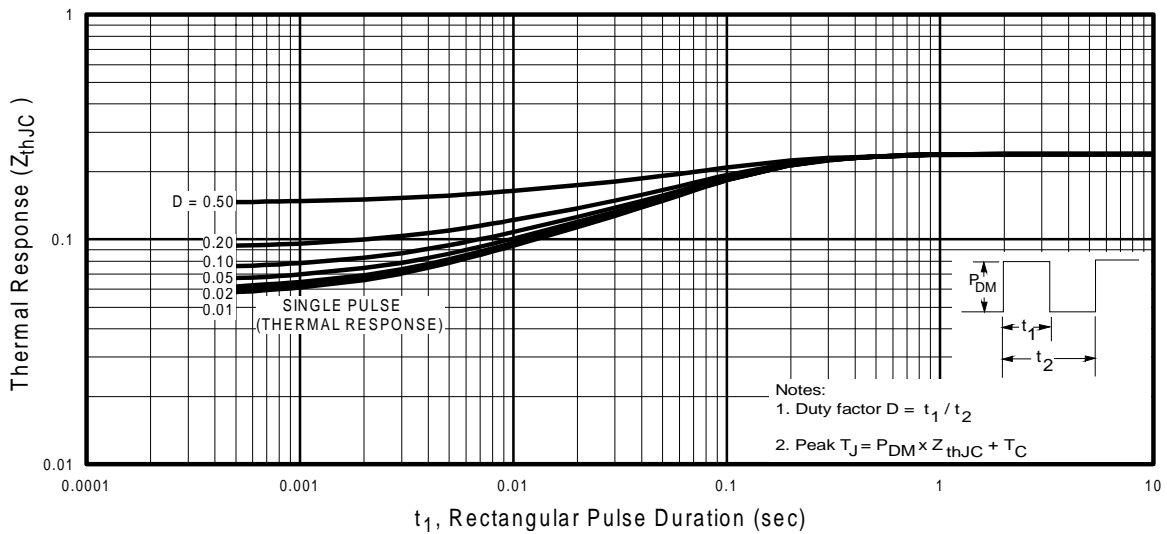

Fig. 6 - Maximum Effective Transient Thermal Impedance, Junction-to-Case

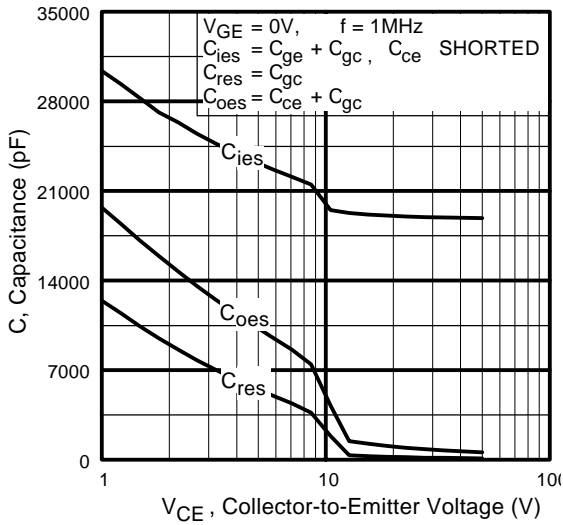

Fig. 7 - Typical Capacitance vs. Collector-to-Emitter Voltage

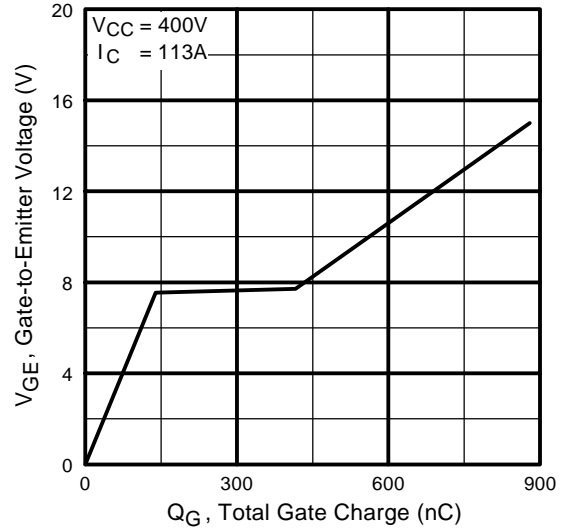

Fig. 8 - Typical Gate Charge vs. Gate-to-Emitter Voltage

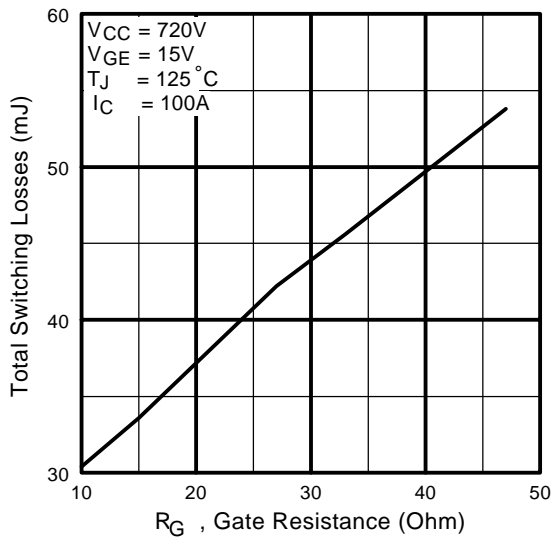

Fig. 9 - Typical Switching Losses vs. Gate Resistance

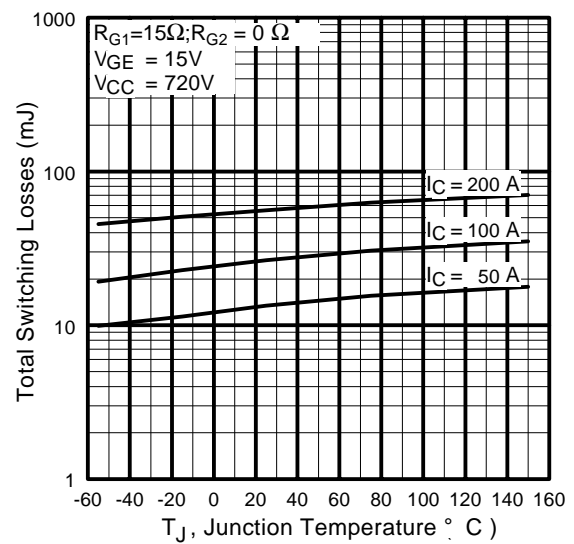

Fig. 10 - Typical Switching Losses vs. Junction Temperature

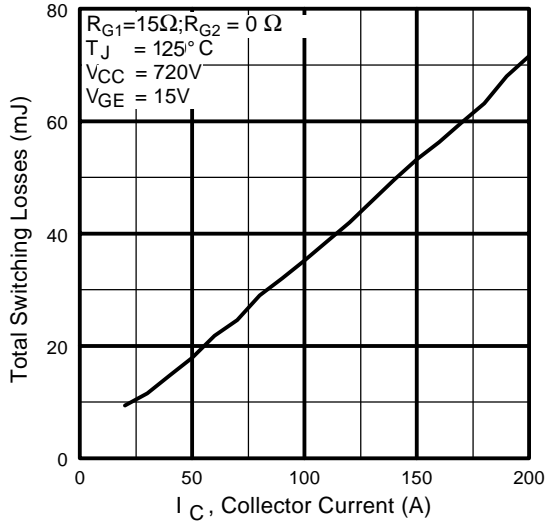

Fig. 11 - Typical Switching Losses vs. Collector Current

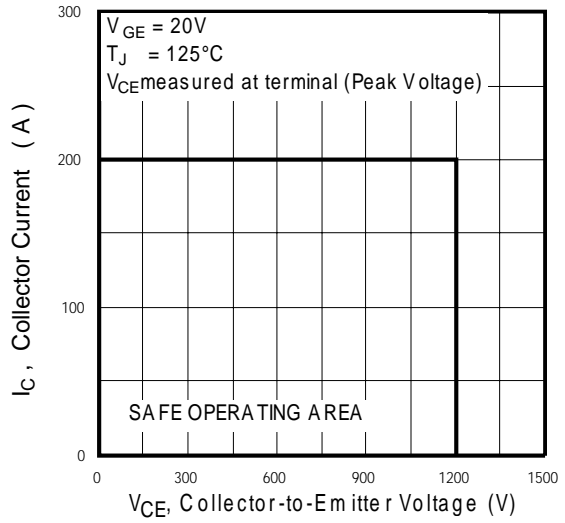

Fig. 12 - Reverse Bias SOA

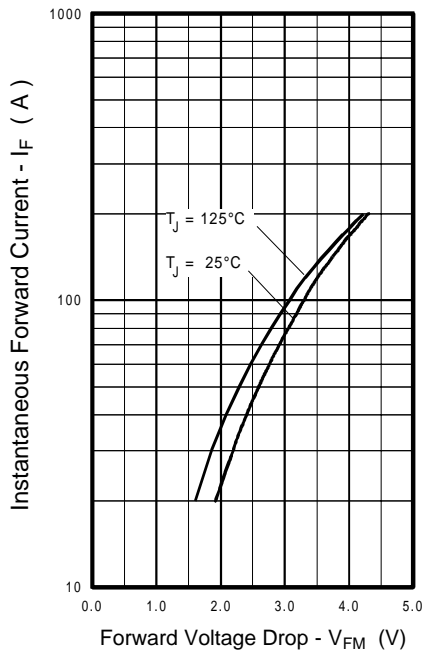

Fig. 13 - Typical Forward Voltage Drop vs. Instantaneous Forward Current

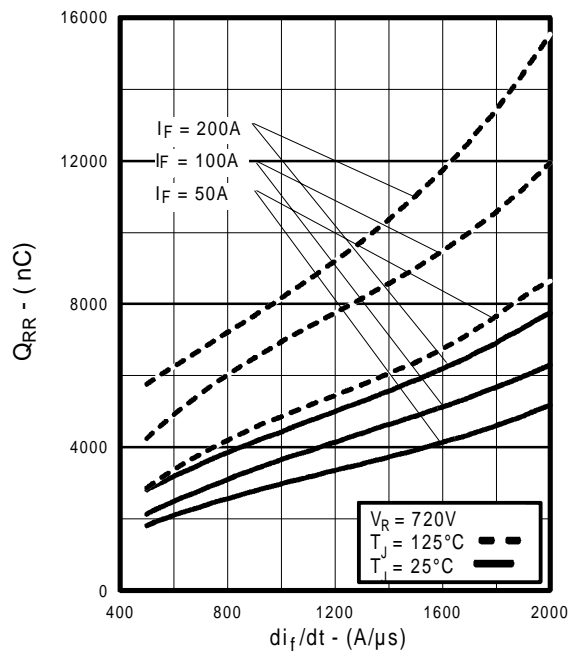

Fig. 14 - Typical Stored Charge vs. di_f/dt

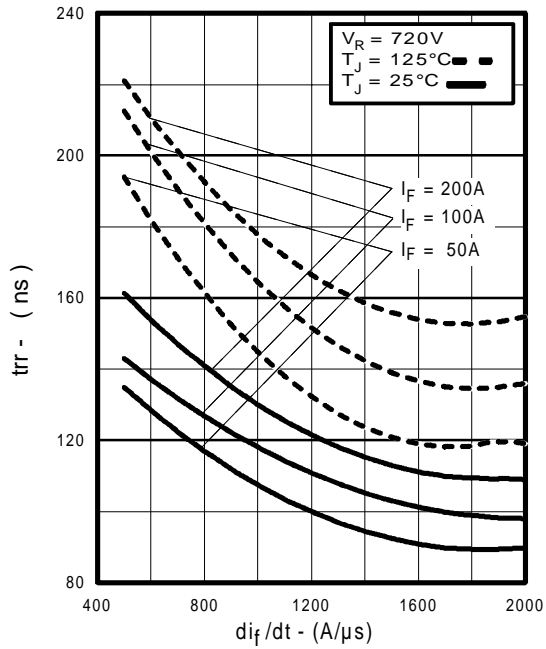

Fig. 15 - Typical Reverse Recovery vs. di_f/dt

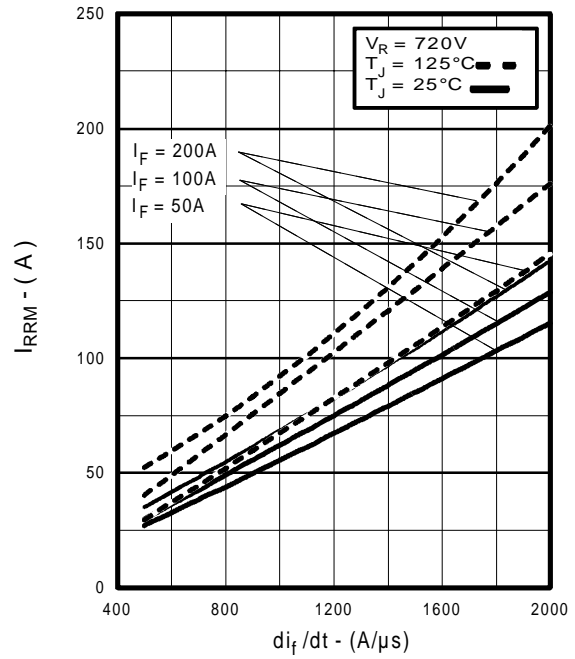

Fig. 16 - Typical Recovery Current vs. di_f/dt

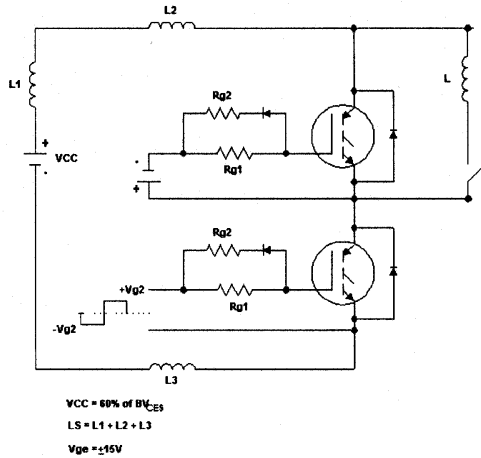

Fig. 17a - Test Circuit for Measurement of I_{LM} , E_{on} , $E_{off}(\text{diode})$, t_{rr} , Q_{rr} , I_{rr} , $t_{d(on)}$, t_r , $t_{d(off)}$, t_f

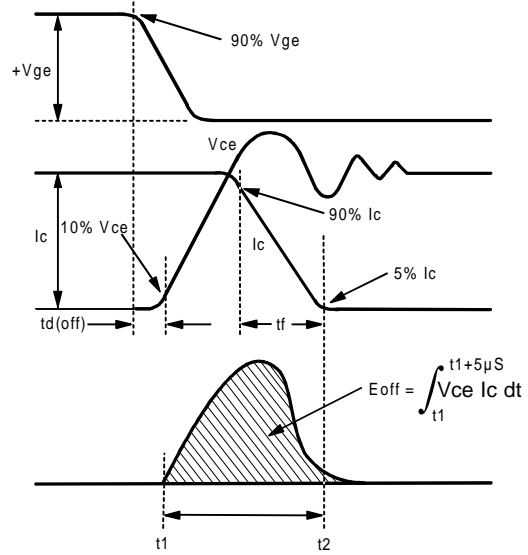

Fig. 17b - Test Waveforms for Circuit of Fig. 18a, Defining E_{off} , $t_{d(off)}$, t_f

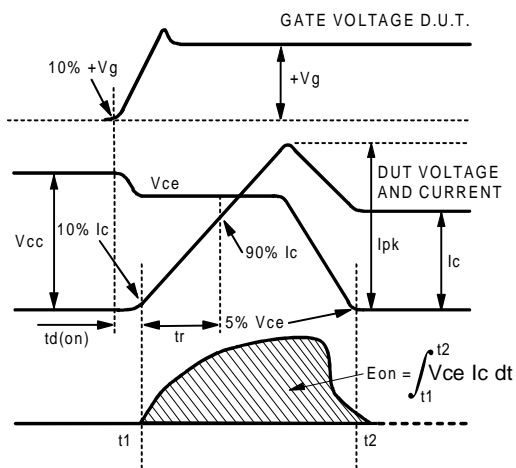

Fig. 17c - Test Waveforms for Circuit of Fig. 18a, Defining E_{on} , $t_{d(on)}$, t_r

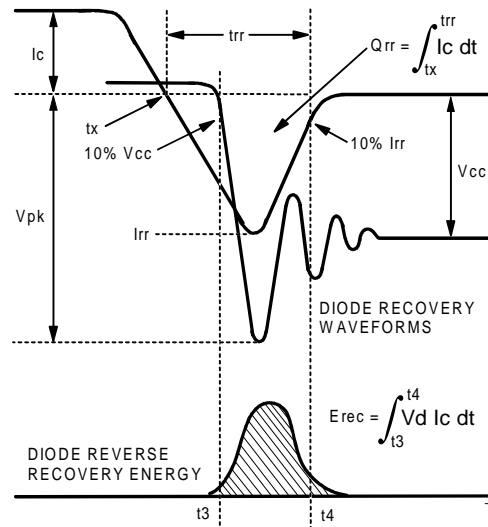

Fig. 17d - Test Waveforms for Circuit of Fig. 18a, Defining E_{rec} , t_{rr} , Q_{rr} , I_{rr}

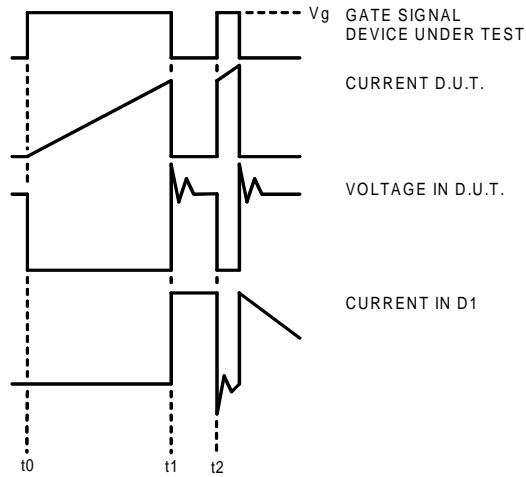

Figure 17e. Macro Waveforms for Figure 18a's Test Circuit

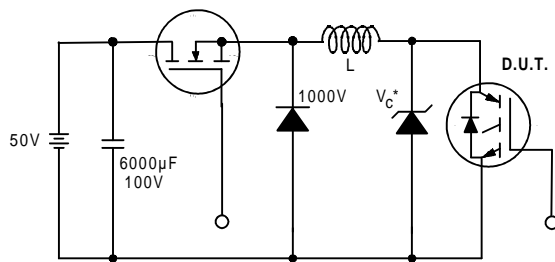

Figure 18. Clamped Inductive Load Test Circuit

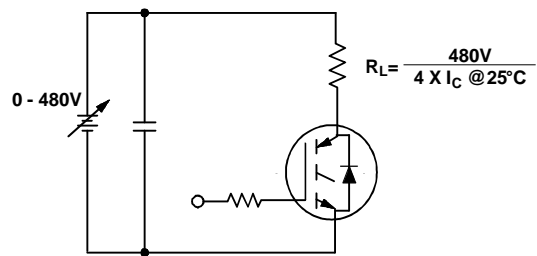

Figure 19. Pulsed Collector Current Test Circuit

GA100TS120U

International
IR Rectifier

Notes:

- ① Repetitive rating; $V_{GE} = 20V$, pulse width limited by max. junction temperature.
- ② See fig. 17
- ③ For screws M5x0.8
- ④ Pulse width 50µs; single shot.

Case Outline — INT-A-PAK

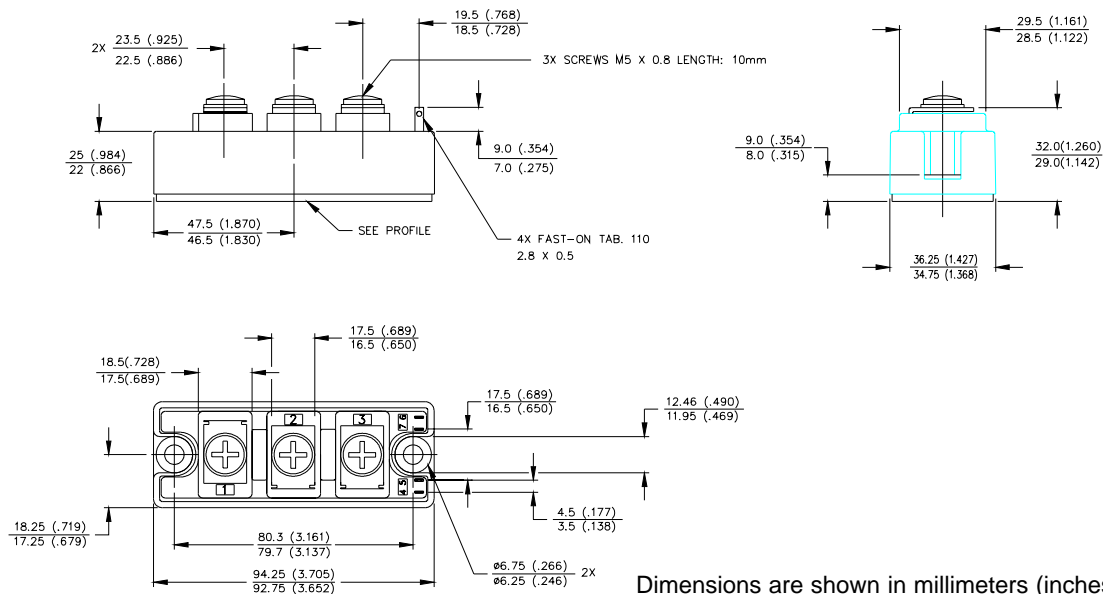

International
IR Rectifier

IR WORLD HEADQUARTERS: 233 Kansas St., El Segundo, California 90245, USA Tel: (310) 252-7105
IR EUROPEAN REGIONAL CENTRE: 439/445 Godstone Rd, Whyteleafe, Surrey CR3 0BL, UK Tel: ++ 44 (0)20 8645 8000
IR CANADA: 15 Lincoln Court, Brampton, Ontario L6T3Z2, Tel: (905) 453 2200
IR GERMANY: Saalburgstrasse 157, 61350 Bad Homburg Tel: ++ 49 (0) 6172 96590
IR ITALY: Via Liguria 49, 10071 Borgaro, Torino Tel: ++ 39 011 451 0111
IR JAPAN: K&H Bldg., 2F, 30-4 Nishi-Ikebukuro 3-Chome, Toshima-Ku, Tokyo 171 Tel: 81 (0)3 3983 0086
IR SOUTHEAST ASIA: 1 Kim Seng Promenade, Great World City West Tower, 13-11, Singapore 237994 Tel: ++ 65 (0)838 4630
IR TAIWAN: 16 Fl. Suite D. 207, Sec. 2, Tun Haw South Road, Taipei, 10673 Tel: 886-(0)2 2377 9936
Data and specifications subject to change without notice. 4/00

This datasheet has been download from:

www.datasheetcatalog.com

Datasheets for electronics components.