



Single Junction Drop-In Circulator



Features

- 24 dB Isolation Typical, 0.25 dB Insertion Loss Typical
- Custom Products Available with Alternate Configurations such as Couplers, Attenuators, Higher Power Terminations, Reverse Circulation and Termination on Ports 1 or 2
- Available as Custom Product Without Flange for Surface Mount Applications (Solder Reflow)
- Designed for Wireless Telecommunications Systems: AMPS, N-AMPS, D-AMPS

Description

M/A-COM's drop-in circulators and isolators, designed for cellular applications, feature high performance at low cost. These designs offer the best isolation per insertion loss ratio in the industry and are currently produced in the tens of thousands of pieces per year. These units can be ordered so as to be compatible with solder reflow manufacturing techniques. Both circulators and isolators are in stock at all authorized M/A-COM distributors.

FR11

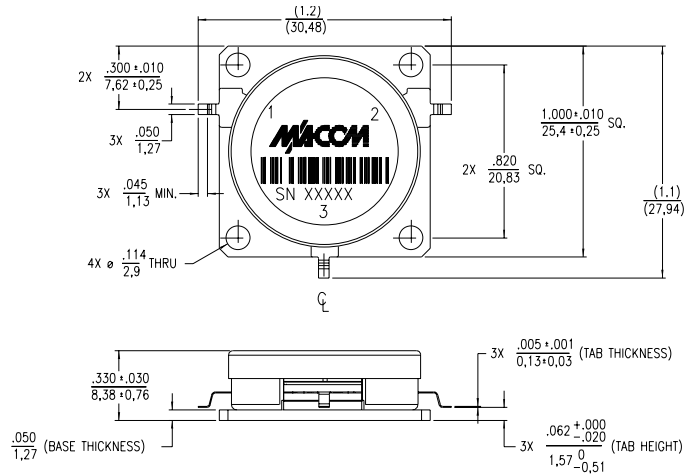

| Part Number | Frequency Range (MHz) |
|-------------|-----------------------|
| FR11-0001 | 869 – 894 |
| FR11-0002 | 925 – 960 |
| FR11-0003 | 1805 – 1880 |
| FR11-0004 | 1930 – 1990 |
| FR11-0005 | 824 – 849 |
| FR11-0006 | 880 – 915 |
| FR11-0007 | 1710 – 1785 |
| FR11-0008 | 1850 – 1910 |

Electrical Specifications

| Parameter | Units | -10 to +60° C | | | -30 to +85° C | | |
|----------------|-------|---------------|------|------|---------------|------|------|
| | | Min. | Typ. | Max. | Min. | Typ. | Max. |
| Isolation | dB | 22 | 24 | — | 20 | 22 | — |
| Insertion Loss | dB | — | 0.25 | 0.3 | — | 0.30 | 0.35 |
| Forward Power | Watts | — | — | 65 | — | — | 65 |
| VSWR | — | — | — | 1.20 | — | — | 1.22 |

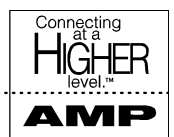

Typical Performance, T = +25°C

FR11-0001

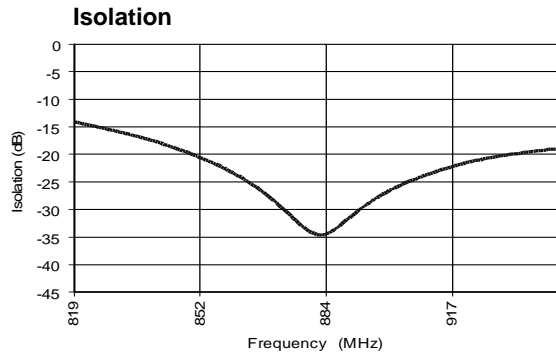

FR11-0002

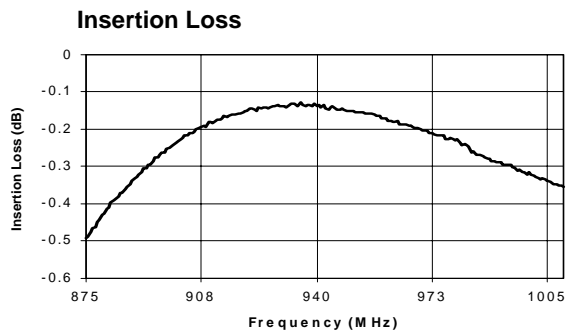
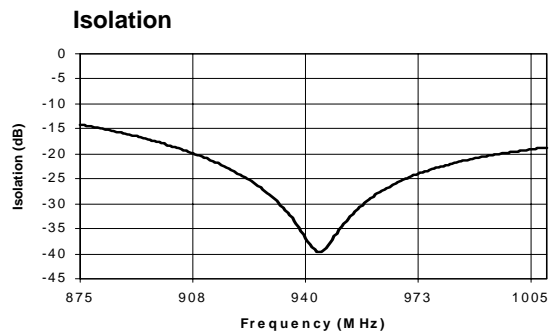

FR11-0003

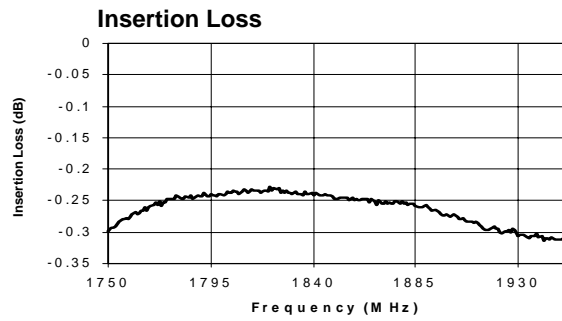
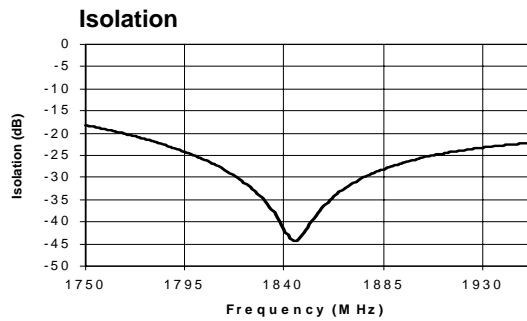

FR11-0004

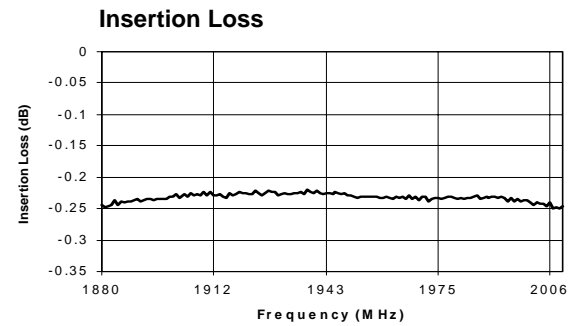
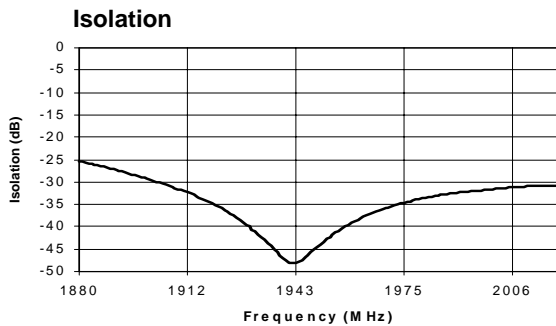

V2.00



This datasheet has been downloaded from:

www.DatasheetCatalog.com

Datasheets for electronic components.