

CL - 205

The CL - 205 is a high - power GaAlAs IRED, with precision optical designed lens. It emits parallel infrared lights.

FEATURES

- TO - 18 can type with glass lense
- Peak emission wavelength $\lambda = 880\text{nm}$
- Illuminant for the parallel light
- High reliability

APPLICATIONS

- Encoders

DIMENSIONS

(Unit : mm)

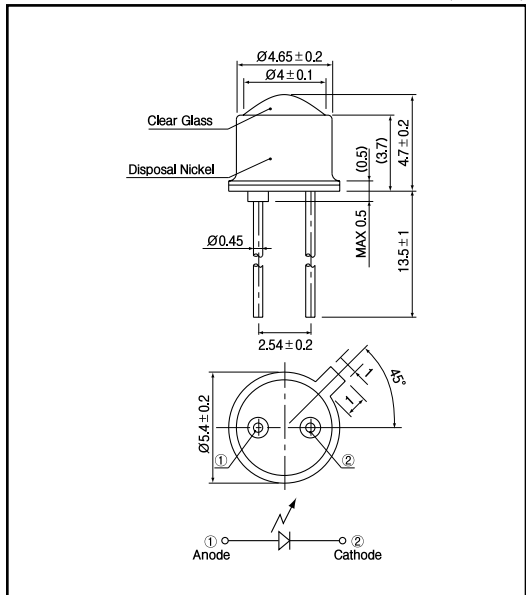

MAXIMUM RATINGS

($T_a = 25^\circ\text{C}$)

Item	Symbol	Rating	Unit
Reverse voltage	V_R	3	V
Forward current	I_F	80	mA
Power dissipation	P_D	160	mW
Pulse forward current ^{*1}	I_{FP}	0.8	A
Operating temp.	$T_{opr.}$	- 30 + 100	
Storage temp.	$T_{stg.}$	- 40 + 125	
Soldering temp. ^{*2}	$T_{sol.}$	260	

*1. pulse width : $t_w \leq 100 \mu\text{sec}$, period : $T = 10\text{msec}$.

*2. For MAX.5 seconds at the position of 2 mm from the package

ELECTRO-OPTICAL CHARACTERISTICS

($T_a = 25^\circ\text{C}$)

Item	Symbol	Conditions	Min.	Typ.	Max.	Unit.
Forward voltage	V_F	$I_F = 50\text{mA}$		1.5	2.0	V
Reverse current	I_R	$V_R = 3\text{V}$			10	μA
Peak emission wavelength	λ_p	$I_F = 50\text{mA}$		870		nm
Spectral bandwidth		$I_F = 50\text{mA}$		50		nm
Radiant intensity ^{*3}	P_D	$I_F = 50\text{mA}$		10		mW
Half angle					± 9	deg.

*3. Measured by tester of KODENSHI CORP.

Infrared Emitting Diodes(GaAlAs)

CL - 205

Power dissipation Vs. Ambient temperature

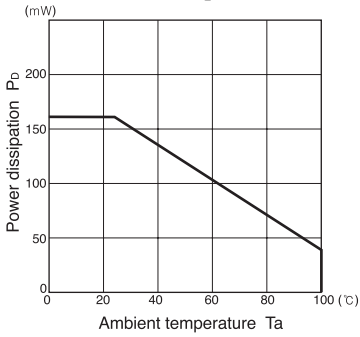

Radiant intensity Vs. Forward current

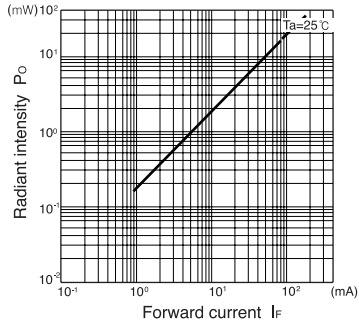

Relative radiant intensity Vs. Ambient temperature

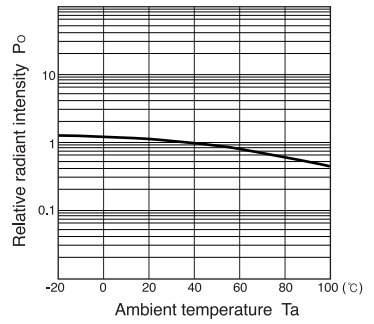

Relative intensity Vs. Wavelength

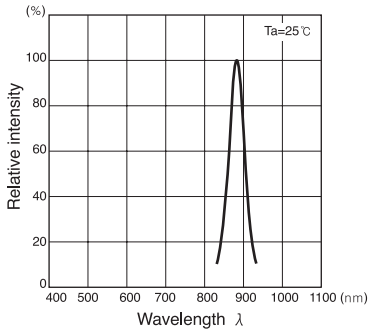

Forward current Vs. Forward voltage

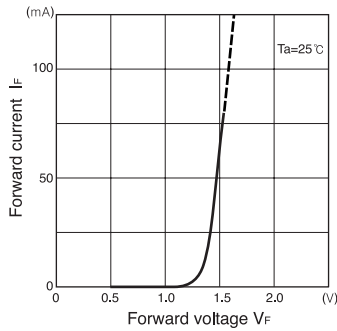

RADIATION PATTERN

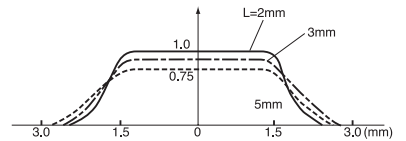

Relative radiant intensity Vs. Distance

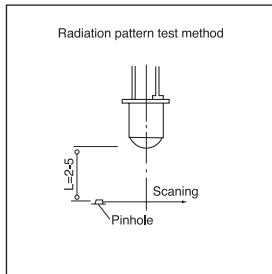
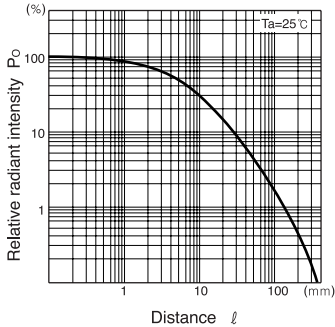

This datasheet has been downloaded from:

www.DatasheetCatalog.com

Datasheets for electronic components.