

Powerex, Inc., 200 Hillis Street, Youngwood, Pennsylvania 15697-1800 (412) 925-7272
 Powerex, Europe, S.A. 428 Avenue G. Durand, BP107, 72003 Le Mans, France (43) 41.14.14

Phase Control SCR
 115 Amperes Average
 1600 Volts

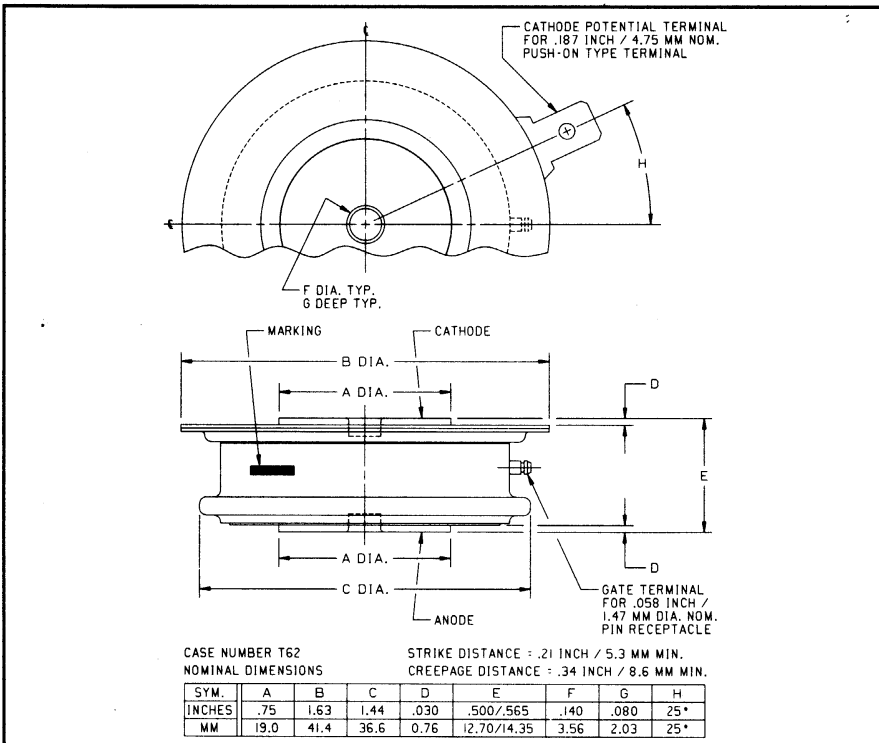

C350 (Outline Drawing)

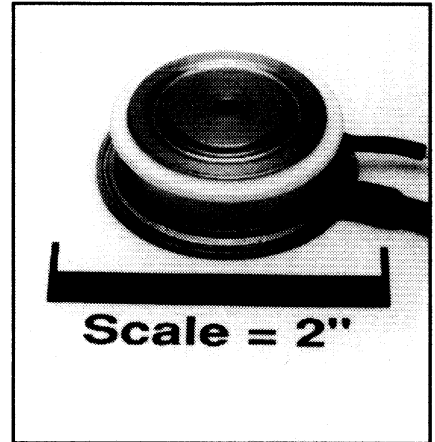

C350 Phase Control SCR
 115 Amperes Average, 1600 Volts

Ordering Information:

Select the complete five or six digit part number you desire from the table, i.e. C350PM is a 1600 Volt, 115 Ampere Phase Control SCR.

Type	Voltage		Current
	V_{DRM} V_{RRM}	Code	$I_{T(av)}$
C350	600	M	115
	800	N	
	1000	P	
	1200	PB	
	1400	PD	
	1600	PM	

Description:

Powerex Silicon Controlled Rectifiers (SCR) are designed for phase control applications. These are all-diffused, Press-Pak (Pow-R-Disc) devices employing the field-proven amplifying (di/namic) gate.

Features:

- Low On-State Voltage
- High di/dt
- High dv/dt
- Hermetic Packaging
- Excellent Surge and I^2t Ratings

Applications:

- Power Supplies
- Battery Chargers
- Motor Control



Powerex, Inc., 200 Hillis Street, Youngwood, Pennsylvania 15697-1800 (412) 925-7272
Powerex, Europe, S.A. 428 Avenue G. Durand, BP107, 72003 Le Mans, France (43) 41.14.14

C350

Phase Control SCR

115 Amperes Average, 1600 Volts

Absolute Maximum Ratings

	Symbol	C350	Units
RMS On-State Current @ $T_C = 89^\circ\text{C}$	$I_{T(\text{RMS})}$	180	Amperes
Average On-State Current @ $T_C = 89^\circ\text{C}$	$I_{T(\text{av})}$	115	Amperes
Peak One-Cycle Surge (Non-Repetitive) On-State Current (60Hz)	I_{TSM}	1600	Amperes
Peak One-Cycle Surge (Non-Repetitive) On-State Current (50Hz)	I_{TSM}	1480	Amperes
Critical Rate-of-Rise of On-State Current (Non-Repetitive)	di/dt	800	Amperes/ μs
Critical Rate-of-Rise of On-State Current (Repetitive)	di/dt	500	Amperes/ μs
I^2t (for Fusing), 8.3 milliseconds	I^2t	10,600	A^2sec
Peak Gate Power Dissipation	P_{GM}	10	Watts
Average Gate Power Dissipation	$P_{G(\text{av})}$	2	Watts
Storage Temperature	T_{STG}	-40 to 150	$^\circ\text{C}$
Operating Temperature	T_J	-40 to 125	$^\circ\text{C}$
Mounting Force		720 to 880	lb.
Mounting Force		3.20 to 3.92	kN

C350
Phase Control SCR
 115 Amperes Average, 1600 Volts

Electrical and Thermal Characteristics

Characteristics	Symbol	Test Conditions	C350	Units
Voltage—Blocking State Maximums				
Forward Leakage, Peak	I_{DRM}	$T_J = 125^\circ\text{C}, V = V_{DRM}$	20	mA
Reverse Leakage, Peak	I_{RRM}	$T_J = 125^\circ\text{C}, V = V_{RRM}$	20	mA
Current—Conducting State Maximums				
Peak On-State Voltage	V_{TM}	$I_{TM} = 500\text{A Peak}, T_C = 25^\circ\text{C}, \text{Duty Cycle} \leq 0.01\%$	2.6	Volts
Switching				
Typical Turn-Off Time	t_q	$T_J = 125^\circ\text{C}; I_{TM} = 50\text{ Amps Peak};$ $V_R = 50\text{ Volts Min.}; V_{DRM} = \text{Rated (Reapplied)};$ Rate-of-Rise of Reapplied Off-State Voltage = $20\text{V}/\mu\text{sec}$ (Linear); Gate Bias = 0 Volts, 100Ω during Turn-Off Interval; Duty Cycle $\leq 0.01\%$	200	μsec
Typical Delay Time	t_d	$T_C = 25^\circ\text{C}, I_{TM} = 50\text{ Adc}, V_{DRM} = \text{Rated},$ Gate Supply: 10 Volt Open Circuit, 20 Ohm, 0.1 μsec max. rise time	1.0	μsec
Min. Critical dv/dt exponential to V_{DRM}	dv/dt	$T_J = 125^\circ\text{C}, \text{Gate Open}$	200	V/ μsec
Thermal				
Maximum Thermal Resistance, double sided cooling Junction to Case	$R_{\theta JC}$		0.135	$^\circ\text{C}/\text{Watt}$
Case to Sink, Lubricated	$R_{\theta CS}$		0.04	$^\circ\text{C}/\text{Watt}$
Gate—Maximum Parameters				
Gate Current to Trigger	I_{GT}	$V_D = 6\text{V}, T_C = 25^\circ\text{C}, R_L = 3\Omega$	150	mA
Gate Voltage to Trigger	V_{GT}	$V_D = 6\text{V}, R_L = 3\Omega, T_J = -40^\circ\text{C to } +120^\circ\text{C}$	3.0	Volts
Non-Triggering Gate Voltage	V_{GDM}	$T_C = 120^\circ\text{C}, \text{Rated } V_{DRM}, R_L = 1000\Omega$	0.15	Volts
Peak Forward Gate Current	I_{GTM}		10	Amperes
Peak Reverse Gate Voltage	V_{GRM}		5	Volts

Powerex, Inc., 200 Hillis Street, Youngwood, Pennsylvania 15697-1800 (412) 925-7272
 Powerex, Europe, S.A. 428 Avenue G. Durand, BP107, 72003 Le Mans, France (43) 41.14.14

C350
Phase Control SCR
 115 Amperes Average, 1600 Volts

MAXIMUM ON-STATE CHARACTERISTICS

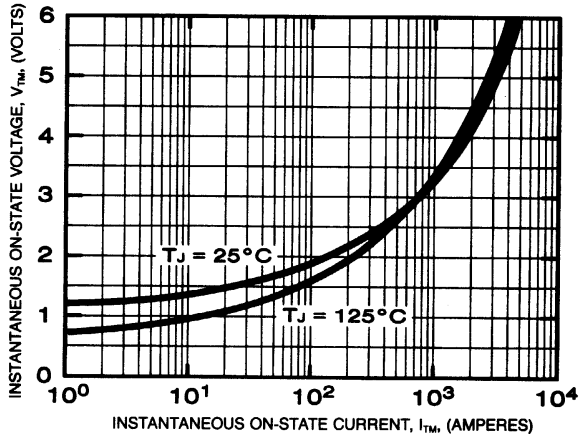

TRANSIENT THERMAL IMPEDANCE CHARACTERISTICS (JUNCTION TO CASE)

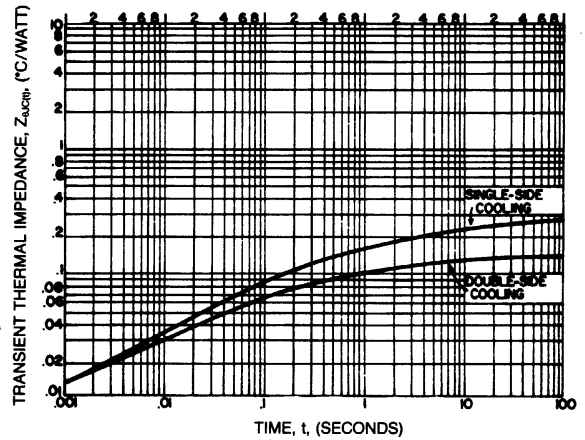

MAXIMUM ALLOWABLE CASE TEMPERATURE (SINUSOIDAL WAVEFORM)

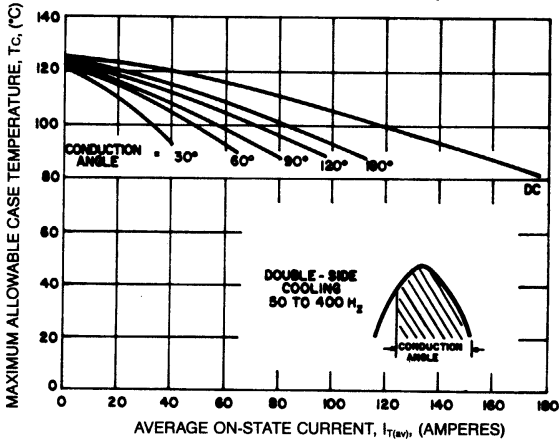

MAXIMUM ON-STATE POWER DISSIPATION (SINUSOIDAL WAVEFORM)

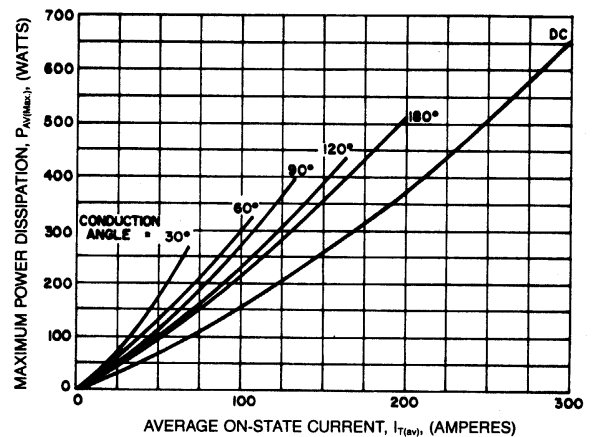

MAXIMUM ALLOWABLE CASE TEMPERATURE (RECTANGULAR WAVEFORM)

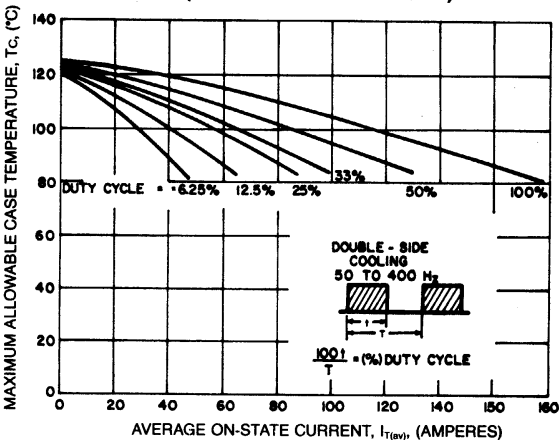

MAXIMUM ON-STATE POWER DISSIPATION (RECTANGULAR WAVEFORM)

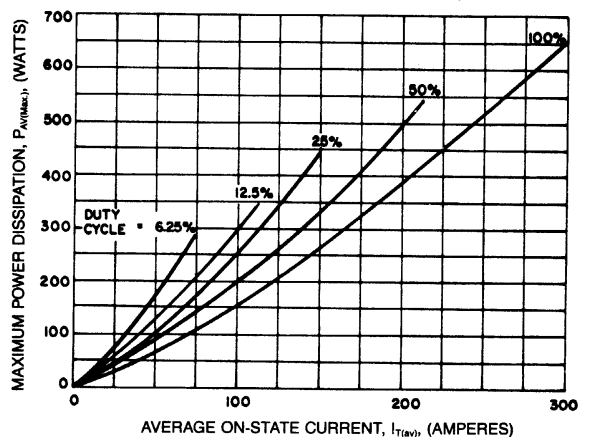

Powerex, Inc., 200 Hillis Street, Youngwood, Pennsylvania 15697-1800 (412) 925-7272
 Powerex, Europe, S.A. 428 Avenue G. Durand, BP107, 72003 Le Mans, France (43) 41.14.14

C350
Phase Control SCR
 115 Amperes Average, 1600 Volts

**MAXIMUM ALLOWABLE CASE TEMPERATURE
 (SINUSOIDAL WAVEFORM)**

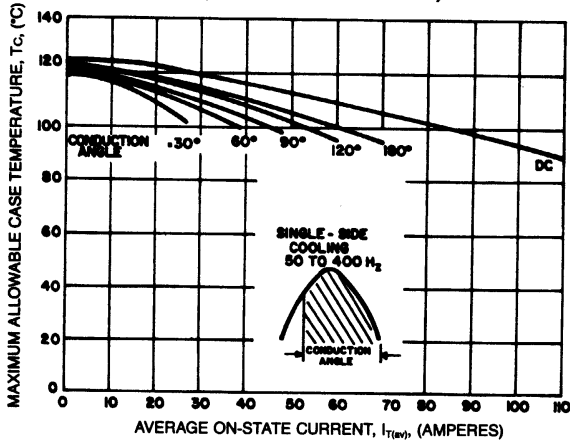

**MAXIMUM ALLOWABLE CASE TEMPERATURE
 (RECTANGULAR WAVEFORM)**

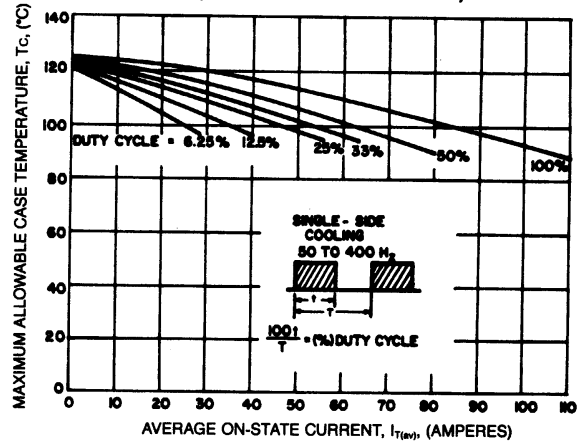

**MAXIMUM ON-STATE POWER DISSIPATION
 (SINUSOIDAL WAVEFORM EXTENDED)**

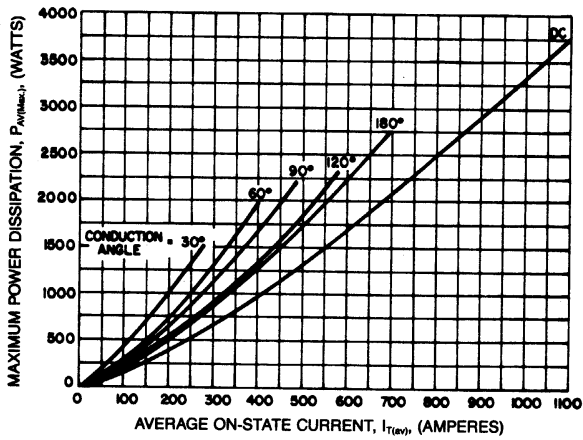

Powerex, Inc., 200 Hillis Street, Youngwood, Pennsylvania 15697-1800 (412) 925-7272
 Powerex, Europe, S.A. 428 Avenue G. Durand, BP107, 72003 Le Mans, France (43) 41.14.14

C350
Phase Control SCR
 115 Amperes Average, 1600 Volts

SUB-CYCLE SURGE AND I^2t RATINGS
 (RATED LOAD CONDITIONS)

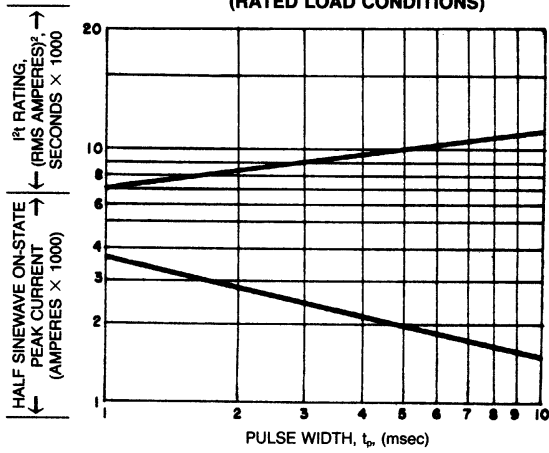

MAXIMUM ALLOWABLE SURGE ON-STATE CURRENT (NON-REPETITIVE)

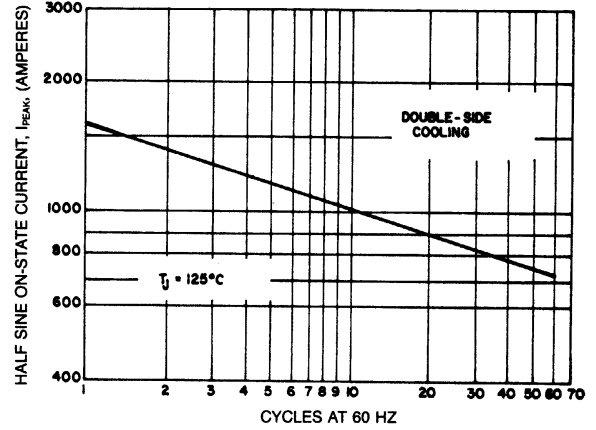

GATE CHARACTERISTICS

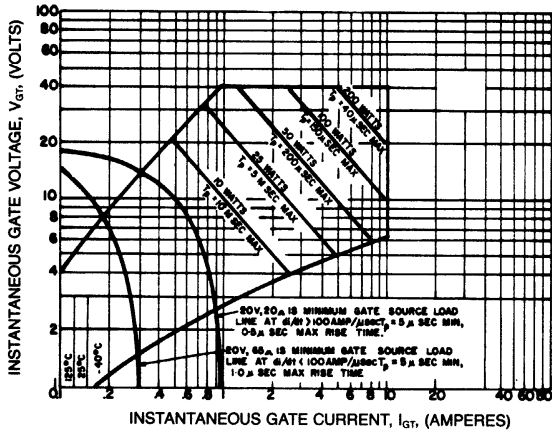

- NOTES:**
1. Maximum allowable gate power dissipation = 2 watts.
 2. The locus of possible DC trigger points lie outside the boundaries shown at various case temperatures.
 3. T_p = Rectangular Gate Current Pulse Width.

This datasheet has been download from:

www.datasheetcatalog.com

Datasheets for electronics components.