

## PNP Silicon Darlington Transistors

**BCV 26**  
**BCV 46**

- For general AF applications
- High collector current
- High current gain
- Complementary types: BCV 27, BCV 47 (NPN)

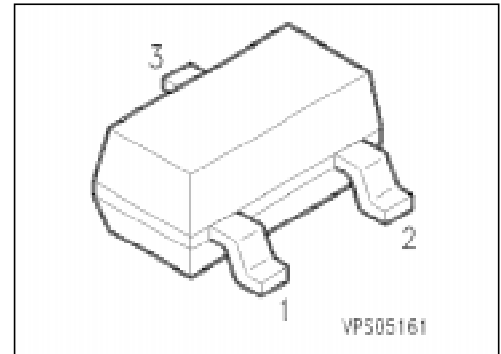

Type	Marking	Ordering Code (tape and reel)	Pin Configuration			Package <sup>1)</sup>
			1	2	3	
BCV 26	FDs	Q62702-C1493	B	E	C	SOT-23
BCV 46	FEs	Q62702-C1475				

### Maximum Ratings

Parameter	Symbol	Values		Unit
		BCV 26	BCV 46	
Collector-emitter voltage	$V_{CE0}$	30	60	V
Collector-base voltage	$V_{CB0}$	40	80	
Emitter-base voltage	$V_{EB0}$	10	10	
Collector current	$I_C$	500		mA
Peak collector current	$I_{CM}$	800		
Base current	$I_B$	100		
Peak base current	$I_{BM}$	200		
Total power dissipation, $T_s = 74\text{ °C}$	$P_{tot}$	360		mW
Junction temperature	$T_j$	150		°C
Storage temperature range	$T_{stg}$	- 65 ... + 150		

### Thermal Resistance

Junction - ambient <sup>2)</sup>	$R_{th\ JA}$	≤ 280	K/W
Junction - soldering point	$R_{th\ JS}$	≤ 210	

1) For detailed information see chapter Package Outlines.

2) Package mounted on epoxy pcb 40 mm × 40 mm × 1.5 mm/6 cm<sup>2</sup> Cu.

## Electrical Characteristics

at  $T_A = 25\text{ °C}$ , unless otherwise specified.

Parameter	Symbol	Values			Unit
		min.	typ.	max.	

### DC characteristics

Collector-emitter breakdown voltage $I_C = 10\text{ mA}$	$V_{(BR)CE0}$				V
BCV 26		30	—	—	
BCV 46		60	—	—	
Collector-base breakdown voltage $I_C = 100\text{ }\mu\text{A}$	$V_{(BR)CB0}$				
BCV 26		40	—	—	
BCV 46		80	—	—	
Emitter-base breakdown voltage, $I_E = 10\text{ }\mu\text{A}$	$V_{(BR)EB0}$	10	—	—	
Collector cutoff current $V_{CB} = 30\text{ V}$	$I_{CB0}$				nA
BCV 26		—	—	100	
$V_{CB} = 60\text{ V}$					nA
BCV 46		—	—	100	
$V_{CB} = 30\text{ V}, T_A = 150\text{ °C}$					$\mu\text{A}$
BCV 26		—	—	10	
$V_{CB} = 60\text{ V}, T_A = 150\text{ °C}$					$\mu\text{A}$
BCV 46		—	—	10	
Emitter cutoff current, $V_{EB} = 4\text{ V}$	$I_{EB0}$	—	—	100	nA
DC current gain <sup>1)</sup> $I_C = 100\text{ }\mu\text{A}, V_{CE} = 1\text{ V}$	$h_{FE}$				—
BCV 26		4000	—	—	
BCV 46		2000	—	—	
$I_C = 10\text{ mA}, V_{CE} = 5\text{ V}$					
BCV 26		10000	—	—	
BCV 46		4000	—	—	
$I_C = 100\text{ mA}, V_{CE} = 5\text{ V}$					
BCV 26		20000	—	—	
BCV 46		10000	—	—	
$I_C = 0.5\text{ A}, V_{CE} = 5\text{ V}$					
BCV 26		4000	—	—	
BCV 46		2000	—	—	
Collector-emitter saturation voltage <sup>1)</sup> $I_C = 100\text{ mA}, I_B = 0.1\text{ mA}$	$V_{CEsat}$	—	—	1	V
Base-emitter saturation voltage <sup>1)</sup> $I_C = 100\text{ mA}, I_B = 0.1\text{ mA}$	$V_{BEsat}$	—	—	1.5	

### AC characteristics

Transition frequency $I_C = 50\text{ mA}, V_{CE} = 5\text{ V}, f = 20\text{ MHz}$	$f$	—	200	—	MHz
Output capacitance $V_{CB} = 10\text{ V}, f = 1\text{ MHz}$	$C_{obo}$	—	4.5	—	pF

<sup>1)</sup> Pulse test:  $t \leq 300\text{ }\mu\text{s}, D = 2\%$ .

**Total power dissipation  $P_{tot} = f(T_A^*; T_S)$**

\* Package mounted on epoxy

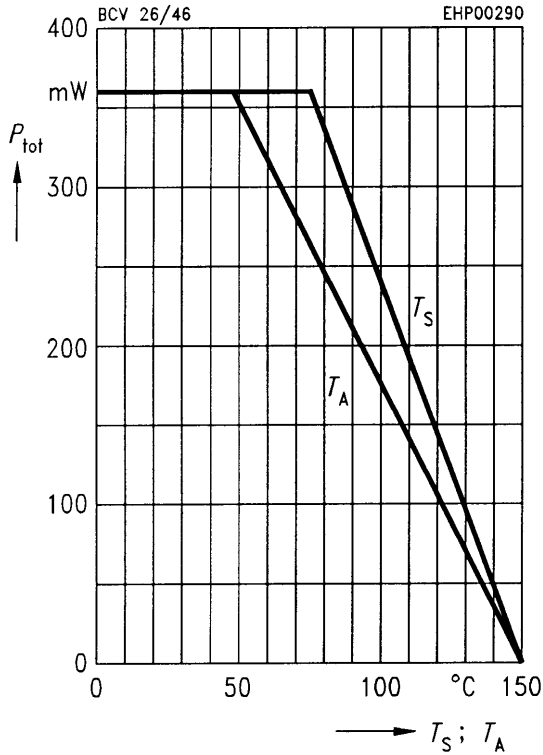

**Collector-base capacitance  $C_{CB0} = f(V_{CB0})$**

**Emitter-base capacitance  $C_{EB0} = f(V_{EB0})$**

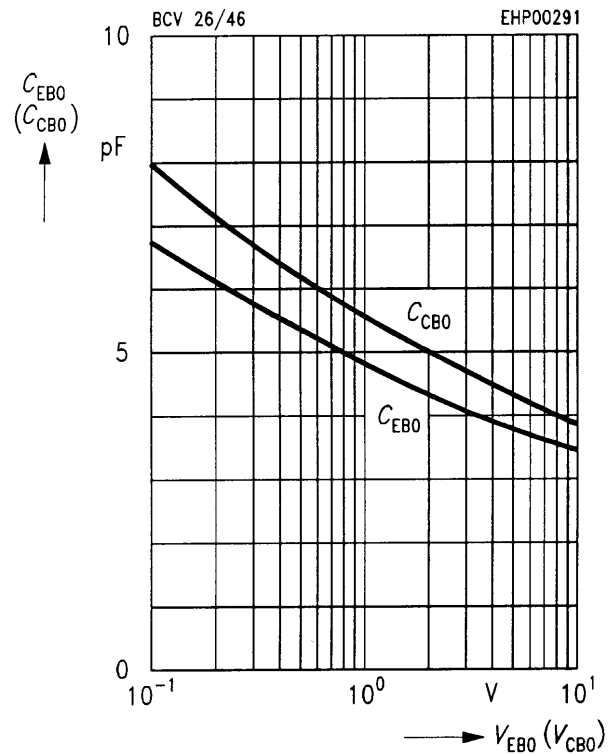

**Permissible pulse load  $P_{tot max}/P_{tot DC} = f(t_p)$**

**Transition frequency  $f_T = f(I_C)$**

$V_{CE} = 5 V$

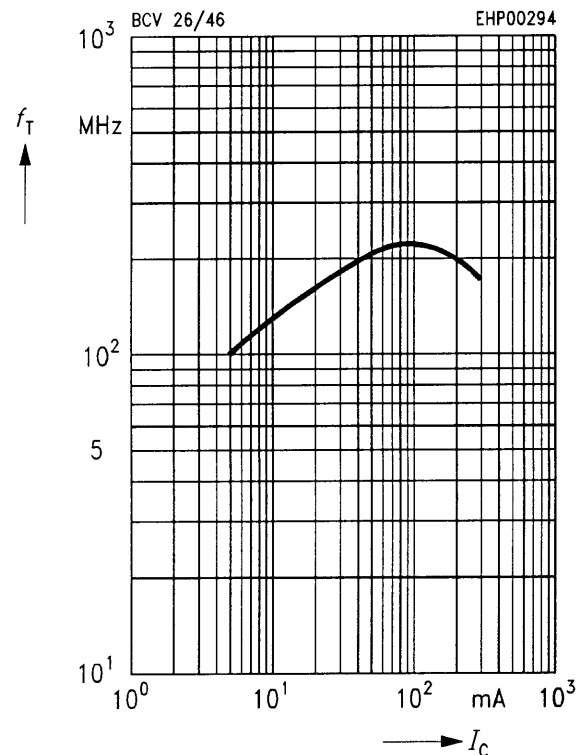
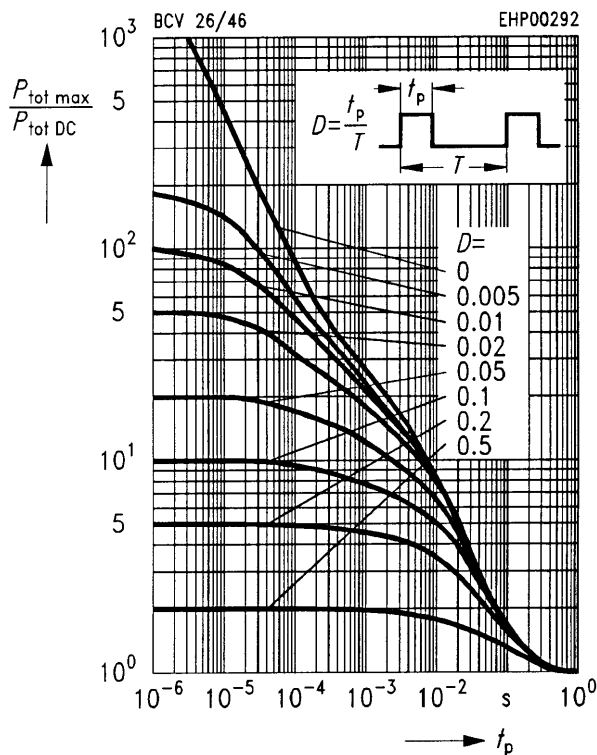

**Base-emitter saturation voltage**

$I_C = f(V_{BEsat})$   
 $h_{FE} = 1000$

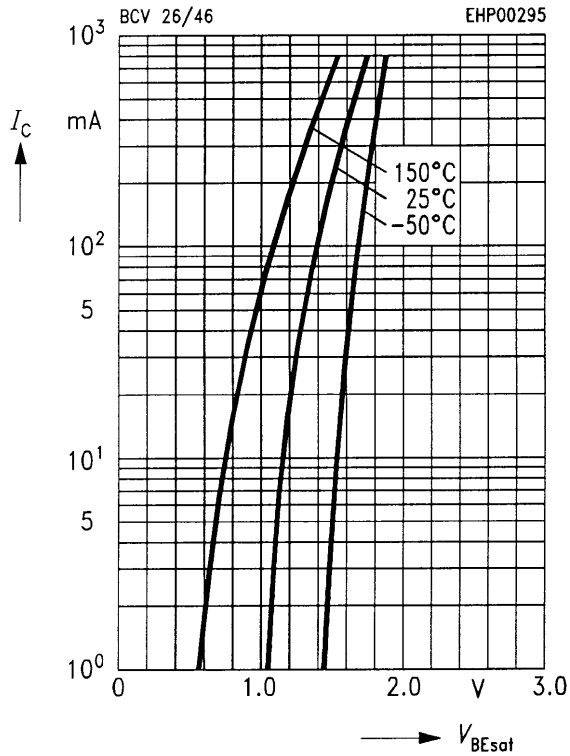

**Collector-emitter saturation voltage**

$I_C = f(V_{CEsat})$   
 $h_{FE} = 1000$

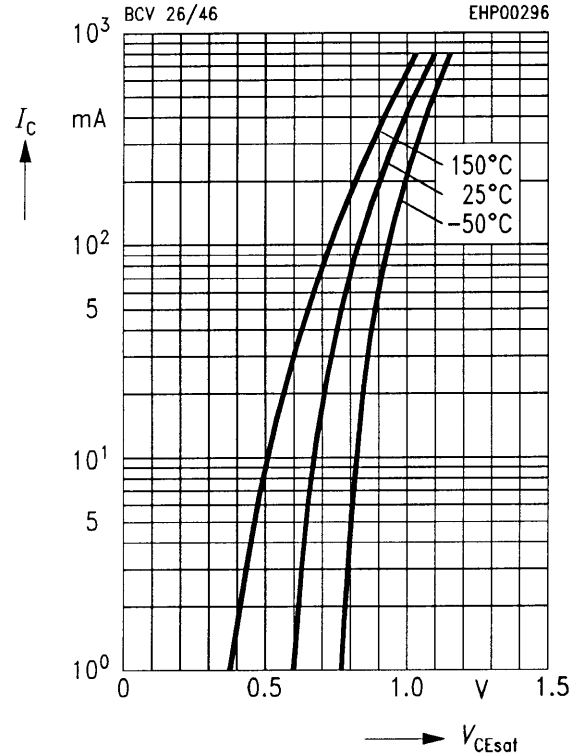

**Collector cutoff current  $I_{CB0} = f(T_A)$**

$V_{CB} = V_{CE max}$

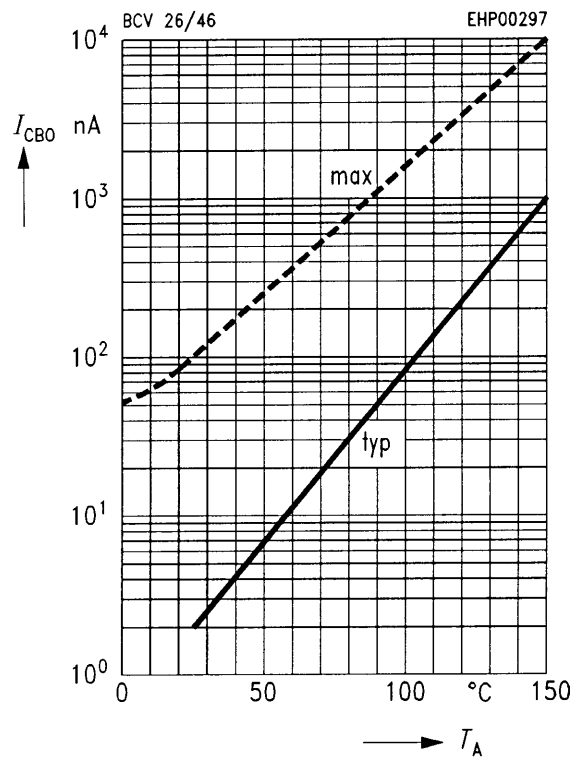

**DC current gain  $h_{FE} = f(I_C)$**

$V_{CE} = 5 V$

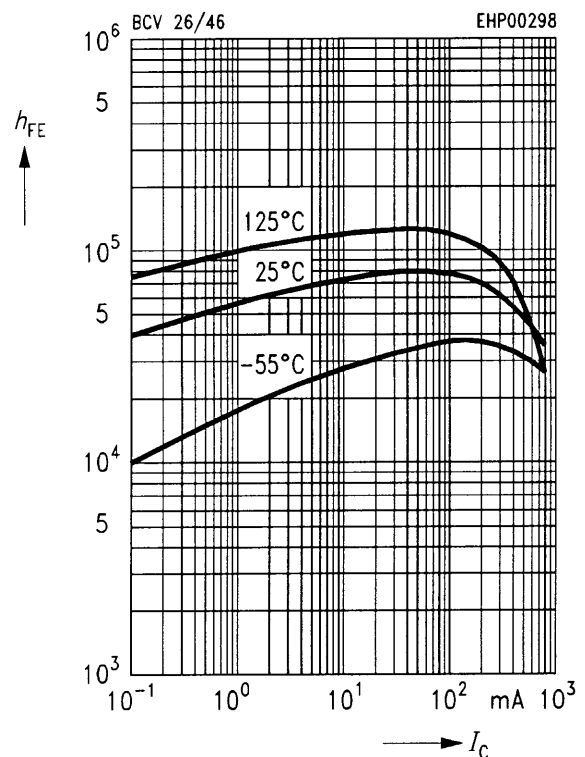

This datasheet has been download from:

[www.datasheetcatalog.com](http://www.datasheetcatalog.com)

Datasheets for electronics components.