

ANSALDO**Ansaldo Trasporti s.p.a.
Unita' Semiconduttori**Via N. Lorenzi 8 - I 16152 GENOVA - ITALY
Tel. int. +39/(0)10 6556549 - (0)10 6556488
Fax Int. +39/(0)10 6442510
Tx 270318 ANSUSE I -**FAST RECOVERY DIODE****ARF463**

Repetitive voltage up to	4500 V
Mean forward current	730 A
Surge current	10 kA

FINAL SPECIFICATION

apr 97 - ISSUE : 04

Symbol	Characteristic	Conditions	T _j [°C]	Value	Unit
BLOCKING					
V _{RRM}	Repetitive peak reverse voltage		150	4500	V
V _{RSM}	Non-repetitive peak reverse voltage		150	4600	V
I _{RRM}	Repetitive peak reverse current	V=VRRM	150	50	mA
CONDUCTING					
I _{F(AV)}	Mean forward current	180° sin ,50 Hz, Th=55°C, double side cooled		730	A
I _{F(AV)}	Mean forward current	180° square,50 Hz,Th=55°C,double side cooled		735	A
I _{FSM}	Surge forward current	Sine wave, 10 ms	150	10	kA
I ² t	I ² t	reapplied reverse voltage up to 50% VRSM		500 x1E3	A ² s
V _{FM}	Forward voltage	Forward current : 1800 A	25	2.5	V
V _{F(TO)}	Threshold voltage		150	1.70	V
r _F	Forward slope resistance		150	1.000	mohm
SWITCHING					
t _{rr}	Reverse recovery time	I _F = 600 A	150	5.2	μs
Q _{rr}	Reverse recovery charge	di/dt= 80 A/μs		650	μC
I _{rr}	Peak reverse recovery current	VR = 100 V		250	A
s	Softness (s-factor), min			0.5	
V _{FR}	Peak forward recovery	di/dt= 400 A/μs	150	60	V
MOUNTING					
R _{th(j-h)}	Thermal impedance	Junction to heatsink, double side cooled		37	°C/kW
T _j	Operating junction temperature			-30 / 150	°C
F	Mounting force			11.8 / 13.2	kN
	Mass			300	g
ORDERING INFORMATION : ARF463 S 45					
standard specification <input type="checkbox"/> <input type="checkbox"/> VRRM/100					

DISSIPATION CHARACTERISTICS

SQUARE WAVE

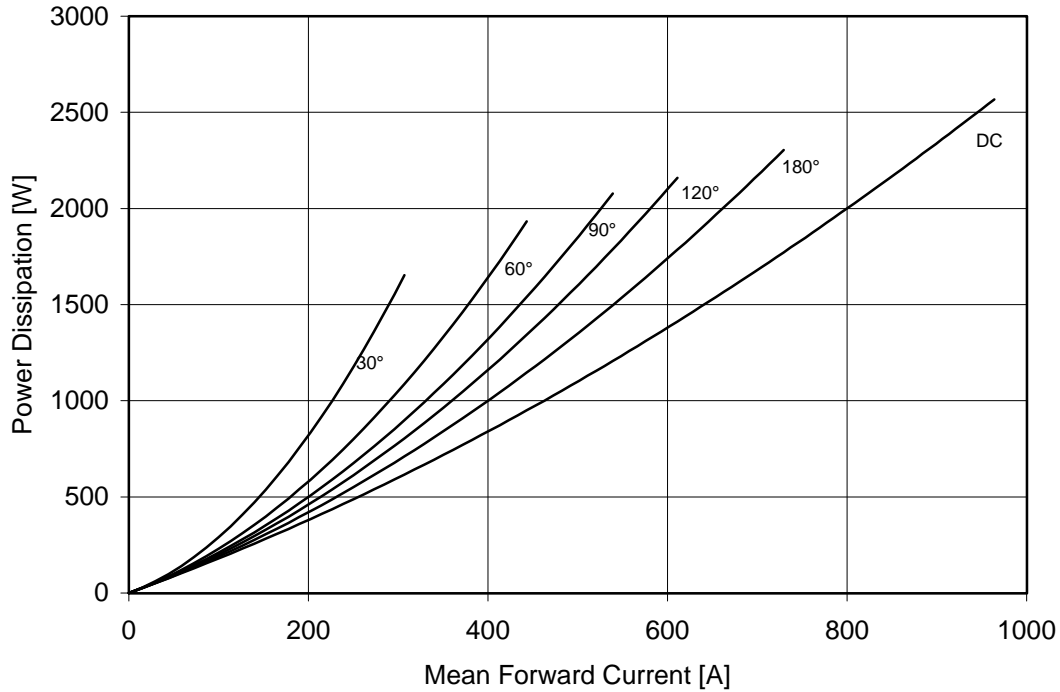

SINE WAVE

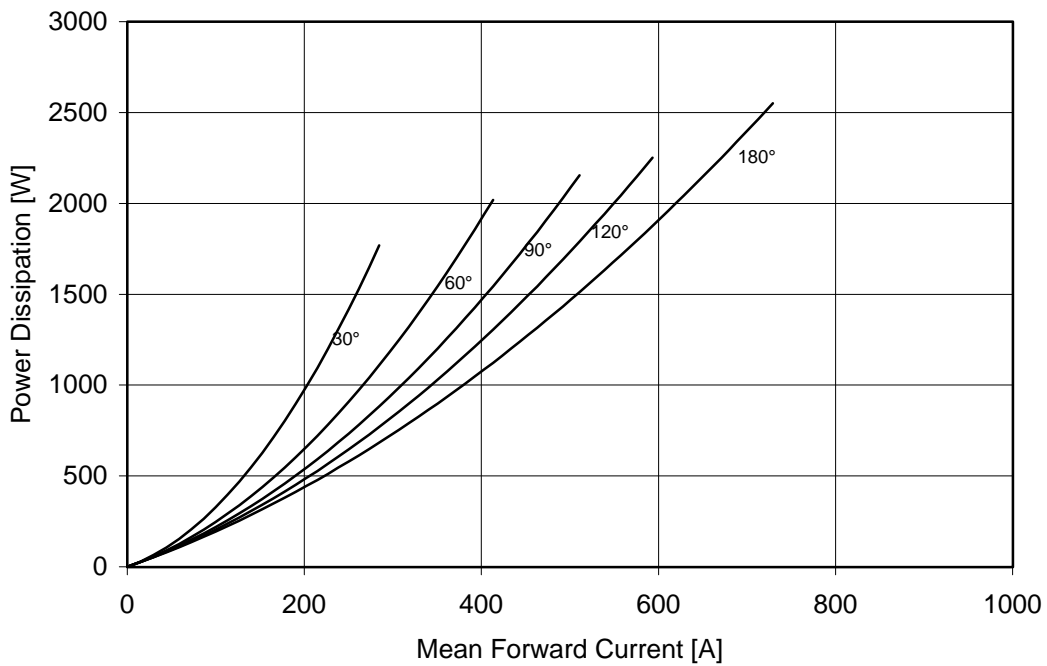

SWITCHING CHARACTERISTICS

FORWARD RECOVERY VOLTAGE

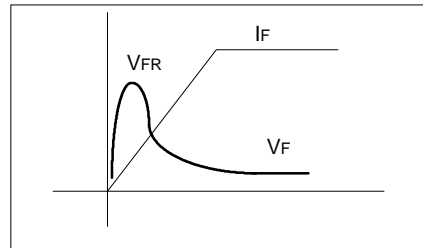
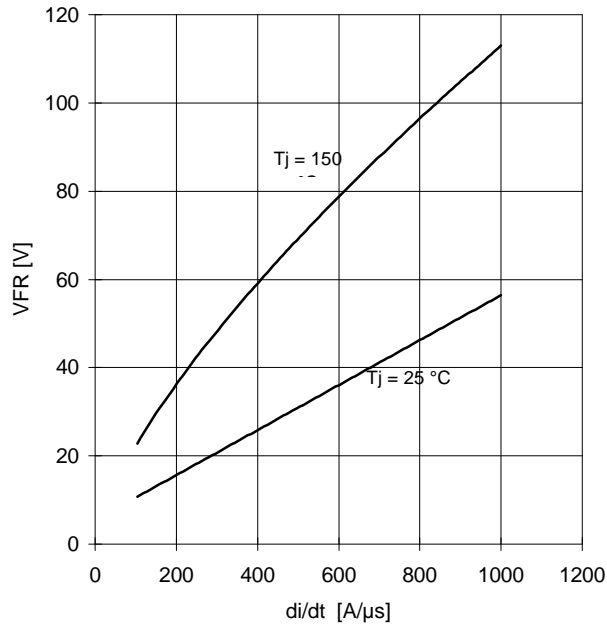

REVERSE RECOVERY CHARGE
Tj = 150 °C

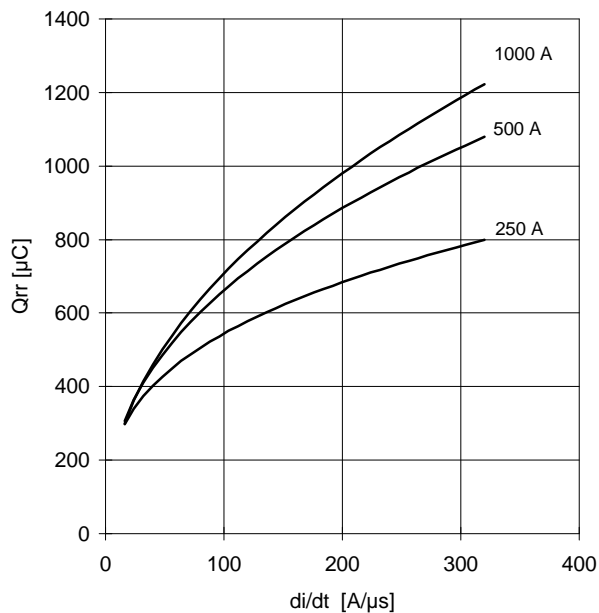

REVERSE RECOVERY CURRENT
Tj = 150 °C

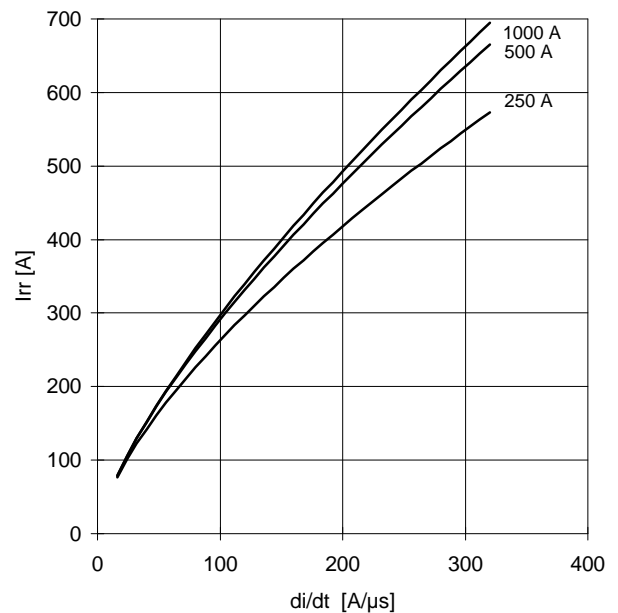

$$t_a = I_{rr} / (di/dt) \quad t_b = t_{rr} - t_a$$

$$\text{Softness (s factor)} \quad s = t_b / t_a$$

$$\text{Energy dissipation during recovery } E_r = V_r \cdot (Q_{rr} - I_{rr} \cdot t_a / 2)$$

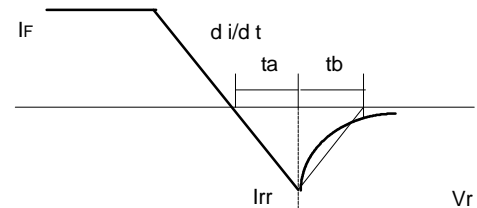

FORWARD CHARACTERISTIC
T_j = 150 °C

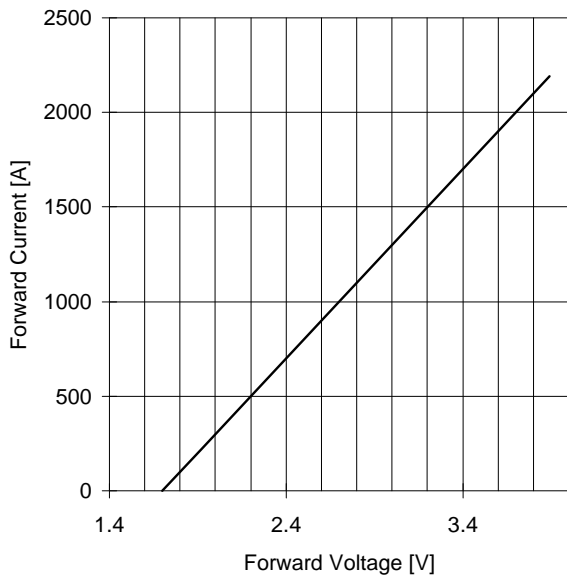

SURGE CHARACTERISTIC
T_j = 150 °C

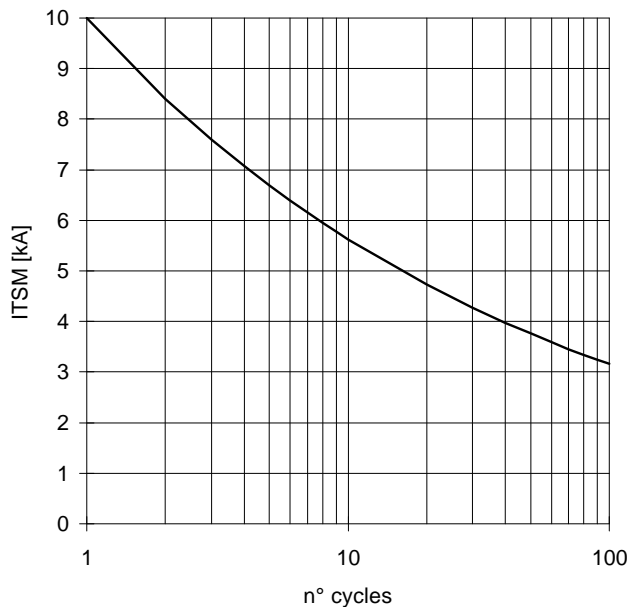

TRANSIENT THERMAL IMPEDANCE
DOUBLE SIDE COOLED

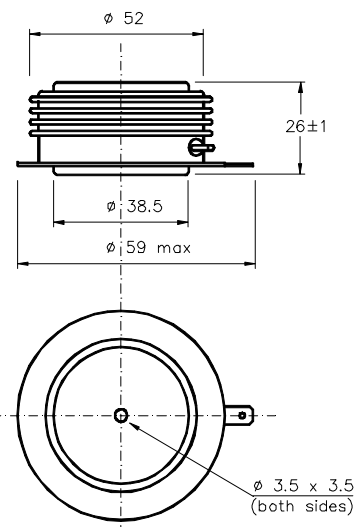
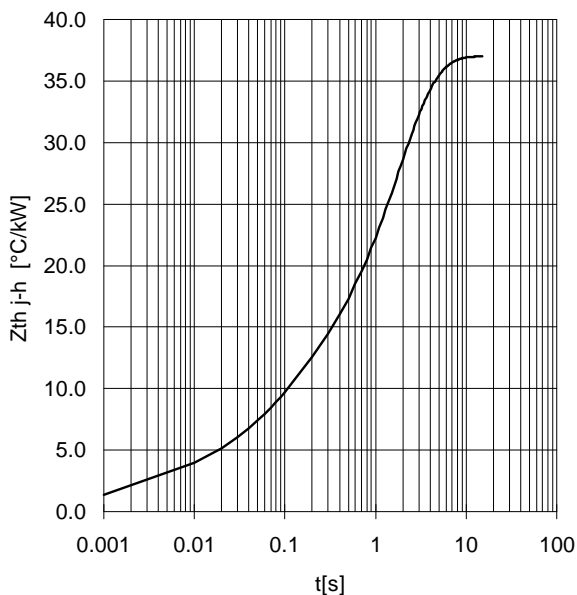

Dimensions
in mm

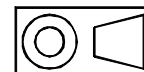

All the characteristics given in this data sheet are guaranteed only with uniform clamping force, cleaned and lubricated heatsink, surfaces with flatness < .03 mm and roughness < 2 μm .

In the interest of product improvement ANSALDO reserves the right to change any data given in this data sheet at any time without previous notice.

If not stated otherwise the maximum value of ratings (symbols over shaded background) and characteristics is reported.

Distributed by

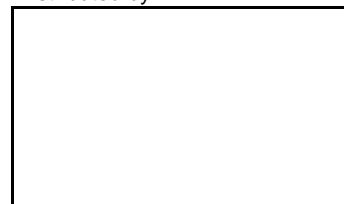

This datasheet has been download from:

www.datasheetcatalog.com

Datasheets for electronics components.