

P-Channel 30-V (D-S) MOSFET

■ Features

- Low $r_{DS(on)}$ Provides Higher Efficiency and Extends Battery Life
- Miniature SO-8 Surface Mount Package Saves Board Space
- High power and current handling capability
- Extended V_{GS} range (± 25) for battery pack applications

■ General Description

These miniature surface mount MOSFETs utilize High Cell Density process. Low $r_{DS(on)}$ assures minimal power loss and conserves energy, making this device ideal for use in power management circuitry. Typical applications are PWM DC-DC converters, power management in portable and battery-powered products such as computers, printers, battery charger, telecommunication power system, and telephones power system.

■ Product Summary

V_{DS} (V)	$r_{DS(on)}$ (m Ω)	I_D (A)
-30	9@ $V_{GS}=-10V$	-15
	13@ $V_{GS}=-4.5V$	-11

■ Pin Assignments

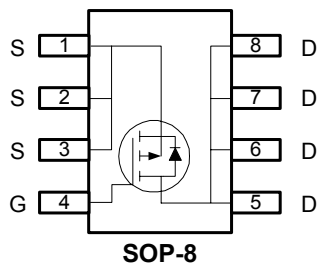

■ Pin Descriptions

Pin Name	Description
S	Source
G	Gate
D	Drain

■ Ordering information

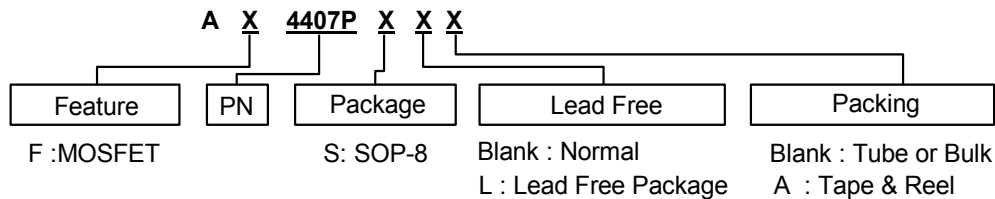



P-Channel 30-V (D-S) MOSFET

■ Absolute Maximum Ratings ($T_A=25^\circ\text{C}$ unless otherwise noted)

Symbol	Parameter	Rating	Units
V_{DS}	Drain-Source Voltage	-30	V
V_{GS}	Gate-Source Voltage	± 25	V
I_D	Continuous Drain Current (Note 1)	$T_A=25^\circ\text{C}$	-15
		$T_A=70^\circ\text{C}$	-11
I_{DM}	Pulsed Drain Current (Note 2)	± 50	A
I_S	Continuous Source Current (Diode Conduction) (Note 1)	-2.1	A
P_D	Power Dissipation (Note 1)	$T_A=25^\circ\text{C}$	3.1
		$T_A=70^\circ\text{C}$	2.3
T_J, T_{STG}	Operating and Storage Junction Temperature Range	-55 to 150	$^\circ\text{C}$

■ Thermal Resistance Ratings

Symbol	Parameter	Maximum	Units
$R_{\theta JC}$	Maximum Junction-to-Case (Note 1)	25	$^\circ\text{C}/\text{W}$
$R_{\theta JA}$	Maximum Junction-to-Ambient (Note 1)	50	$^\circ\text{C}/\text{W}$

Note 1: surface Mounted on 1"x 1" FR4 Board.

Note 2: Pulse width limited by maximum junction temperature

■ Specifications ($T_A=25^\circ\text{C}$ unless otherwise noted)

Symbol	Parameter	Test Conditions	Limits			Unit
			Min.	Typ.	Max.	
Static						
$V_{(BR)DSS}$	Drain-Source breakdown Voltage	$V_{GS}=0\text{V}, I_D=-250\mu\text{A}$	-30	-	-	V
$V_{GS(th)}$	Gate-Threshold Voltage	$V_{DS}=V_{GS}, I_D=-250\mu\text{A}$	-1	-1.6	-3	V
I_{GSS}	Gate-Body Leakage	$V_{DS}=0\text{V}, V_{GS}=\pm 25\text{V}$	-	-	± 100	nA
I_{DSS}	Zero Gate Voltage Drain Current	$V_{DS}=-24\text{V}, V_{GS}=0\text{V}$	-	-	-1	μA
		$V_{DS}=-24\text{V}, V_{GS}=0\text{V}, T_J=55^\circ\text{C}$	-	-	-5	
$I_{D(on)}$	On-State Drain Current (Note 3)	$V_{GS}=-5\text{V}, V_{DS}=-10\text{V}$	-50	-	-	A
$r_{DS(on)}$	Drain-Source On-Resistance (Note 3)	$V_{GS}=-10\text{V}, I_D=-13\text{A}$	-	7.3	9	m Ω
		$V_{GS}=-4.5\text{V}, I_D=-11\text{A}$	-	10	13	
		$V_{GS}=-10\text{V}, I_D=-13\text{A}, T_J=55^\circ\text{C}$	-	9	11	
g_{fs}	Forward Transconductance (Note 3)	$V_{GS}=-5\text{V}, I_D=-13\text{A}$	-	44	-	S
V_{SD}	Diode Forward Voltage	$I_S=2.1\text{A}, V_{GS}=0\text{V}$	-	-0.7	-1.2	V
Dynamic (Note 4)						
Q_g	Total Gate Charge	$V_{DS}=-15\text{V}, V_{GS}=-10\text{V}, I_D=-13\text{A}$	-	71	100	nC
Q_{gs}	Gate-Source Charge		-	12	-	
Q_{gd}	Gate-Drain Charge		-	15	-	
Switching						
$t_{d(on)}$	Turn-On Delay Time	$V_{DD}=-15\text{V}, R_L=6\Omega, I_D=-1\text{A}, V_{GEN}=-10\text{V}$	-	19	36	nS
t_r	Rise Time		-	11	21	
$t_{d(off)}$	Turn-Off Delay Time		-	121	186	
t_f	Fall-Time		-	68	112	

Note 3: Pulse test: $PW \leq 300\mu\text{s}$ duty cycle $\leq 2\%$.

Note 4: Guaranteed by design, not subject to production testing.

P-Channel 30-V (D-S) MOSFET

Typical Performance Characteristics

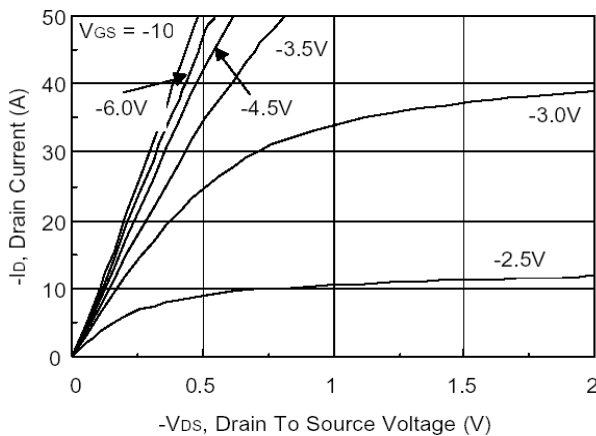

Figure 1. On-Region Characteristics

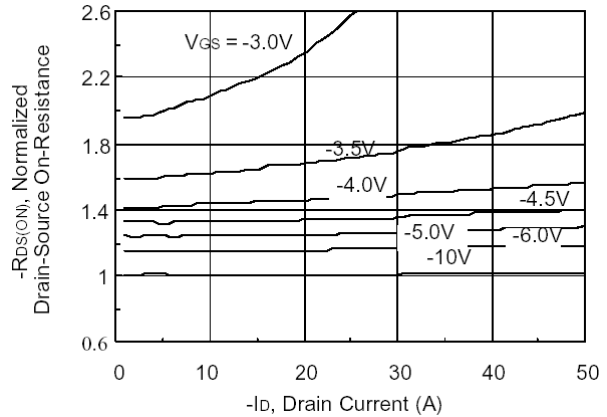

Figure 2. On-Resistance Variation with Drain Current and Gate Voltage

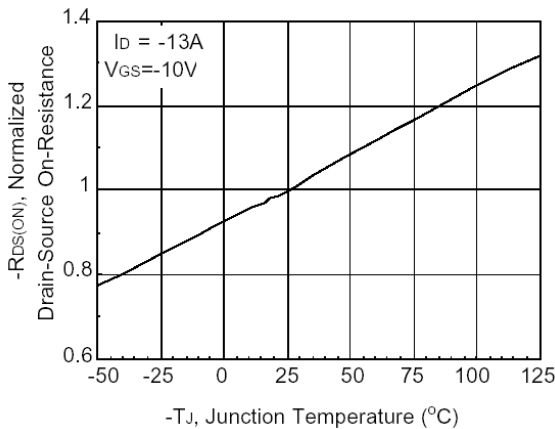

Figure 3. On-Resistance Variation With Temperature

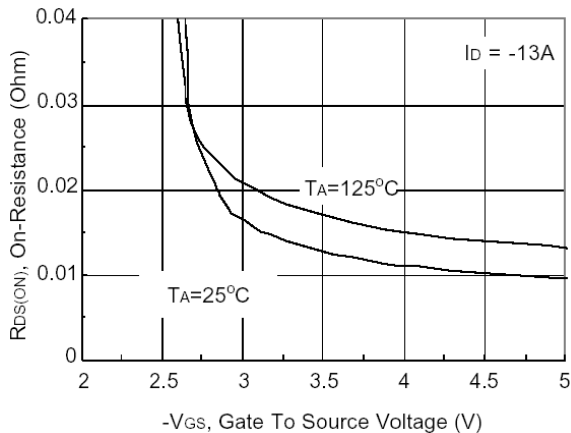

Figure 4. On-Resistance Variation with Gate to Source Voltage

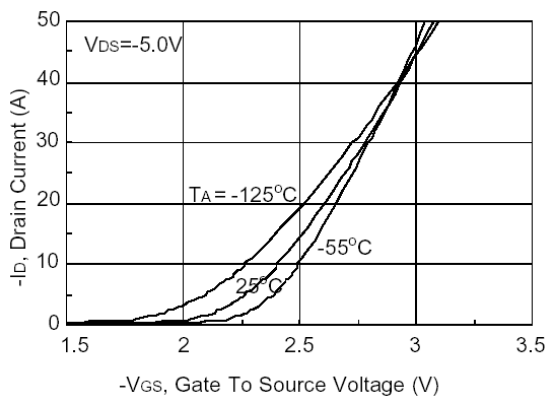

Figure 5. Transfer Characteristics

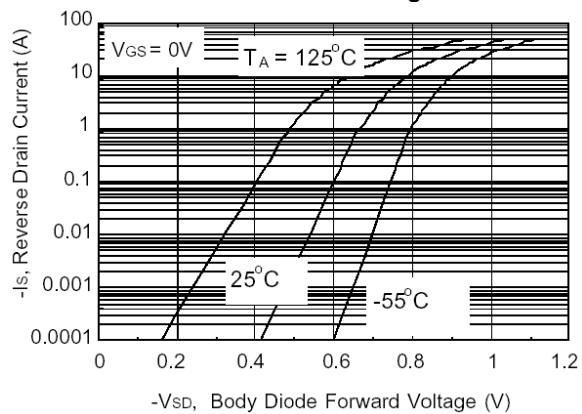

Figure 6. Body Diode Forward Voltage Variation With Source Current and Temperature

P-Channel 30-V (D-S) MOSFET

■ Typical Performance Characteristics (Continued)

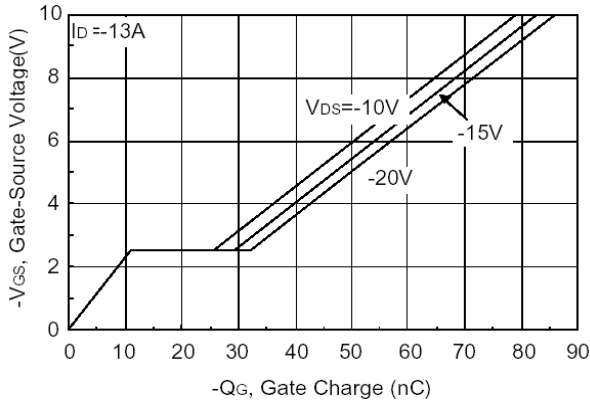

Figure 7. Gate Charge Characteristics

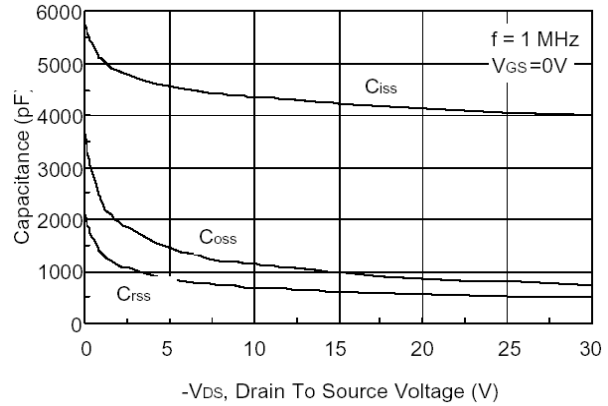

Figure 8. Capacitance Characteristics

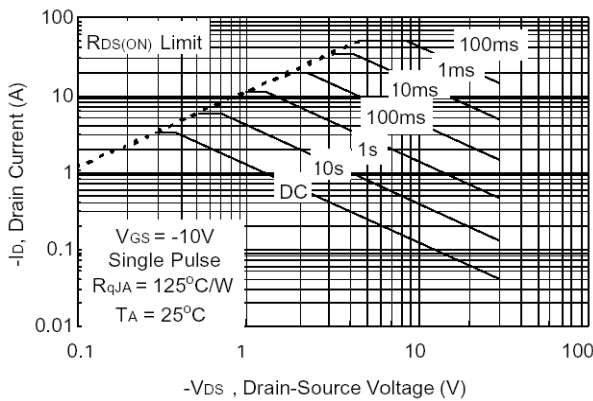

Figure 9. Maximum Safe Operating Area

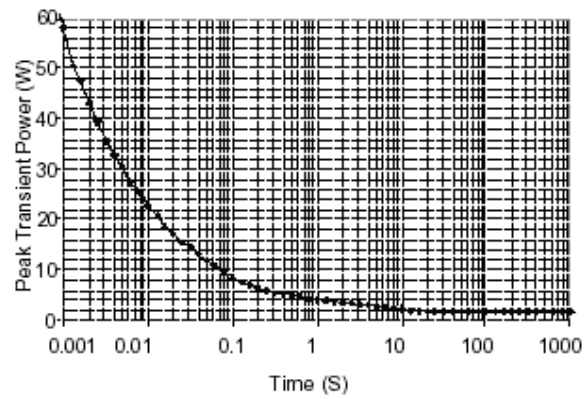

Figure 10. Single Pulse Maximum Power Dissipation

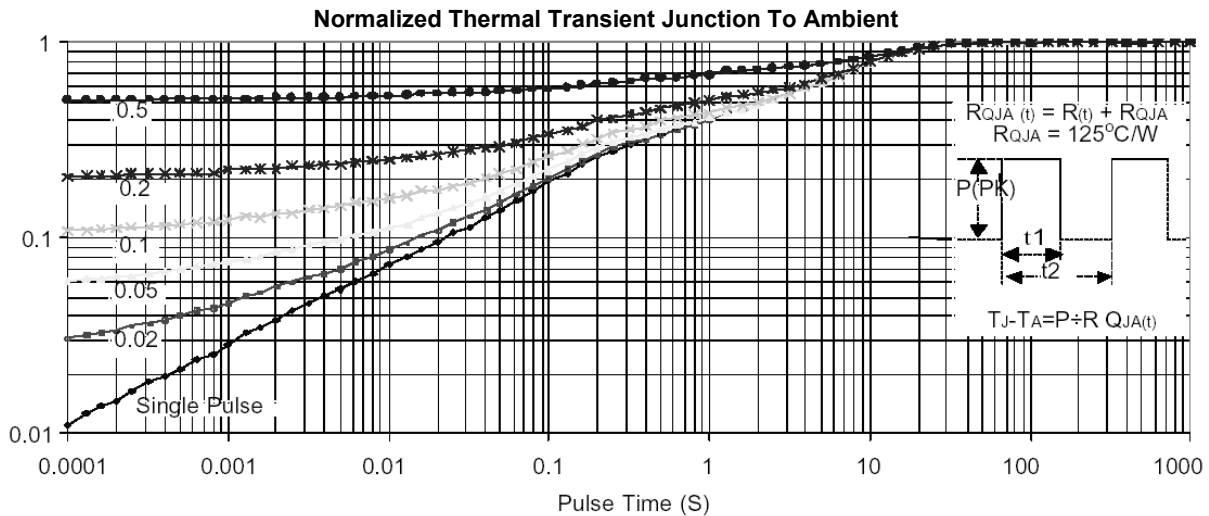
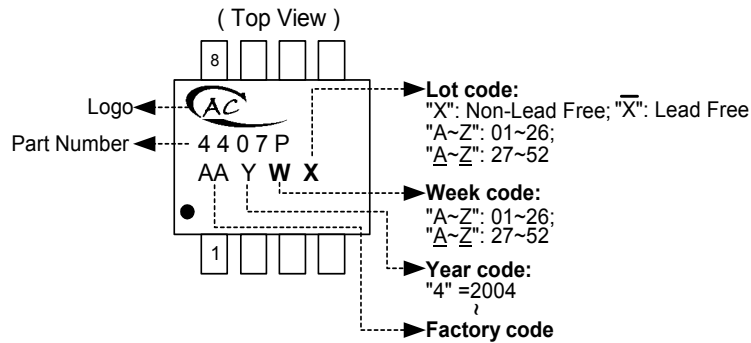

Figure 11. Transient Thermal Response Curve

P-Channel 30-V (D-S) MOSFET

■ Marking Information

SOP-8L



■ Package Information

Package Type: SOP-8L

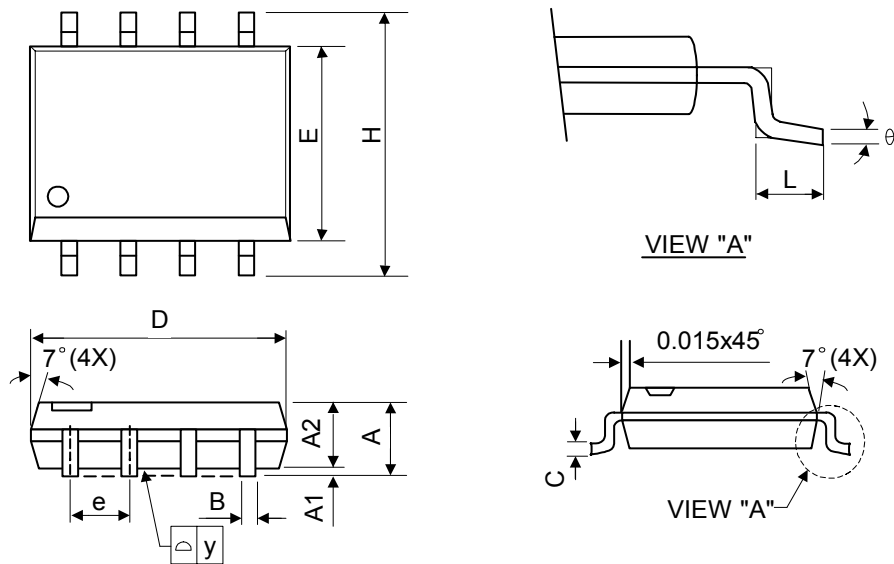

Symbol	Dimensions In Millimeters			Dimensions In Inches		
	Min.	Nom.	Max.	Min.	Nom.	Max.
A	1.40	1.60	1.75	0.055	0.063	0.069
A1	0.10	-	0.25	0.040	-	0.100
A2	1.30	1.45	1.50	0.051	0.057	0.059
B	0.33	0.41	0.51	0.013	0.016	0.020
C	0.19	0.20	0.25	0.0075	0.008	0.010
D	4.80	5.05	5.30	0.189	0.199	0.209
E	3.70	3.90	4.10	0.146	0.154	0.161
e	-	1.27	-	-	0.050	-
H	5.79	5.99	6.20	0.228	0.236	0.244
L	0.38	0.71	1.27	0.015	0.028	0.050
y	-	-	0.10	-	-	0.004
θ	0°	-	8°	0°	-	8°

This datasheet has been download from:

www.datasheetcatalog.com

Datasheets for electronics components.